

SIEMENS

SFH450/750/751

**PLASTIC FIBER OPTIC
TRANSMITTER DIODE**

T-41-07

Preliminary Data Sheet

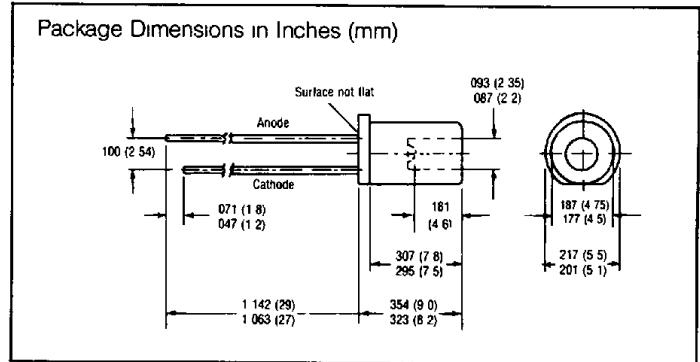
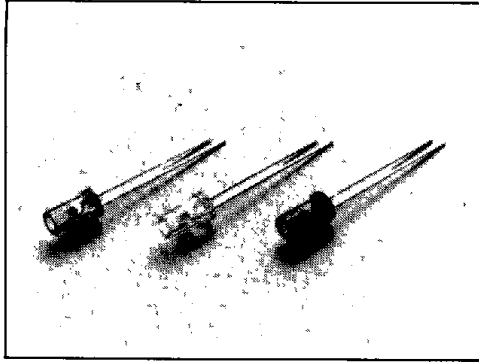

FEATURES

- 2.3 mm Aperture Holds 1000 Micron Plastic Fiber
- No Fiber Stripping Required
- SFH450 – Infrared, Light Grey Plastic Package
- SFH750 – Visible Red, Red Plastic Package
- SFH751 – Visible Green, Green Plastic Package
- High Reliability
- Long Life Time
- Fast Switching Times
- Molded Microlens for Efficient Coupling

DESCRIPTION

The SFH450 is a gallium arsenide (GaAs) infrared emitter. The SFH750 is a gallium arsenide phosphide (GaAsP), visible red emitter; the SFH751 is a gallium phosphide (GaP) visible green emitter. These three devices form a new family of low cost fiber optic components designed for short distance data transmission using 1000 micron core plastic fiber. The devices come in a 5 mm (T1 3/4) plastic package featuring a tubular aperture which is wide enough to accommodate fiber and cladding. A microlens on the bottom of the aperture improves the light coupling efficiency into an inserted plastic fiber.

Typical applications include automotive wiring, isolation interconnects, medical equipment, robotics, electronic games, and copy machines.

Maximum Ratings

		SFH450	SFH750	SFH751	
Operating and Storage Temperature	T		-55 to +100		°C
Junction Temperature	T _J		100		°C
Soldering Temperature (Distance from solder to package = 2 mm)					
Dip Soldering Time t ≤ 5 sec	T _S	260	260	260	°C
Reverse Voltage	V _R	5	5	5	V
Forward Current (DC)	I _F	130	75	45	mA
Surge Current (t ≤ 10 μs, D = 0)	I _{FS}	3.5	1.5	1	A
Power Dissipation	P _{tot}	210	150	150	mW
Thermal Resistance Junction/Air	R _{thJA}	350	500	500	K/W

Electrical Characteristics (T_{amb} = 25°C)

		SFH450	SFH750	SFH751	
Wavelength	λ	950 ± 20	660 ± 15	560 ± 15	nm
Spectral Bandwidth	Δλ	55	35	25	nm
Switching Times					
t _{ON} (10 - 90%)	t _r	1	0.12	0.5	μsec
t _{OFF} (90 - 10%)	t _f	1	0.05	0.2	μsec
Capacitance	C ₀	40	40	11	pF
Forward Voltage	V _F				
I _F = 100 mA		1.3 (≤ 1.5)			V
I _F = 10 mA			1.6 (≤ 2.0)	2.0 (≤ 2.6)	V
Coupling Characteristics into a 1000 Micron Core Plastic Fiber (ESKA EH4001) Distance Fiber to Lens ≤ 0.1 mm, polished ends (I _F = 10 mA)	P _{in}	90	9	3	μW

T-41-07

SFH450
Relative spectral emission

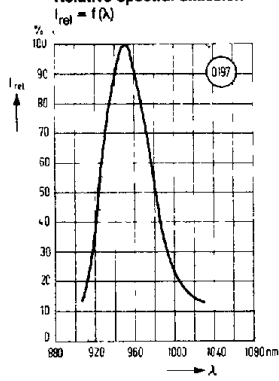

SFH750/751
Relative spectral emission

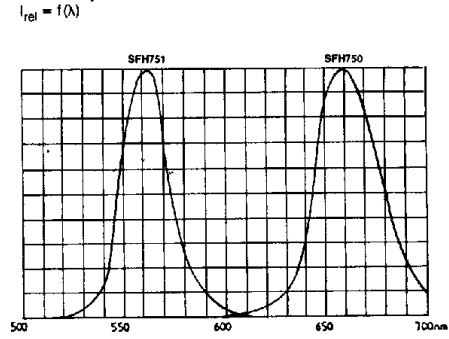

SFH450
Forward current $I_F = f(V_F)$

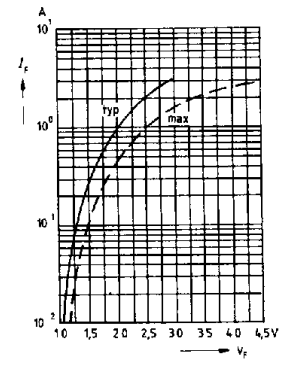

SFH750/751
Forward current $I_F = f(V_F)$

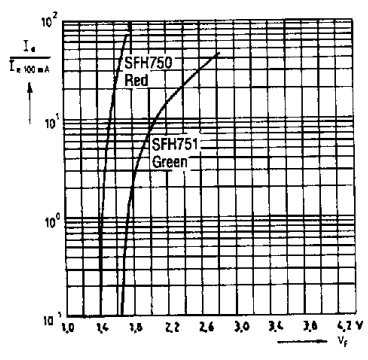

SFH450
Radiant intensity $I_{e,rel} = f(I_F)$ ($\tau = 5 \mu s$, $T = 5$ ms)

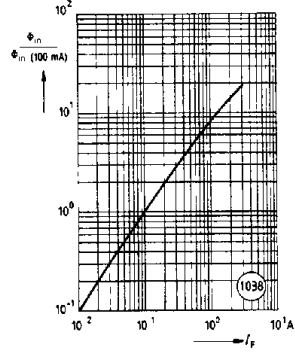

SFH750/751
Radiant intensity $I_{e,rel} = f(I_F)$ ($\tau = 5 \mu s$, $T = 5$ ms)

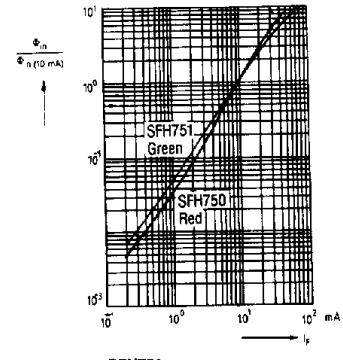

SFH450
Permissible pulse load $I_F = f(\tau)$, $T_{amb} = 25^\circ C$
Duty Cycle $D =$ Parameter

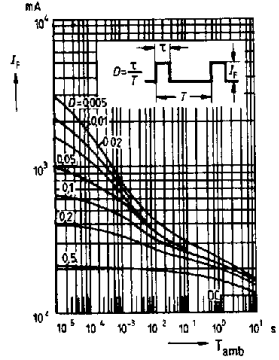

SFH750
Permissible pulse load $I_F = f(\tau)$, $T_{amb} = 25^\circ C$
Duty Cycle $D =$ Parameter

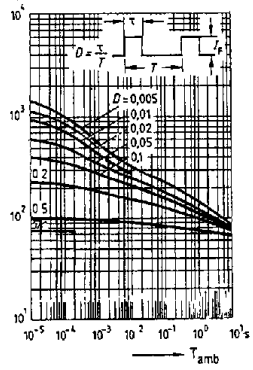

SFH751
Permissible pulse load $I_F = f(\tau)$, $T_{amb} = 25^\circ C$
Duty Cycle $D =$ Parameter

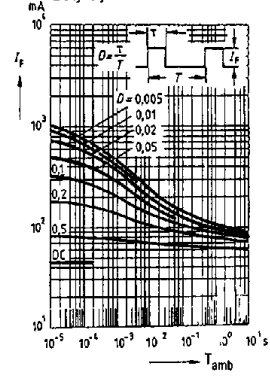

SFH450
Maximum permissible forward current $I_F = f(T_{amb})$

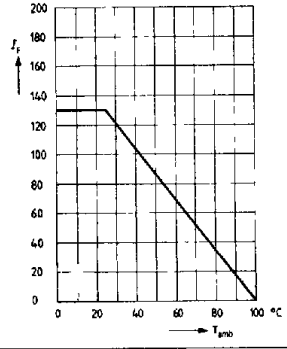

SFH750/751
Maximum permissible forward current $I_F = f(T_{amb})$

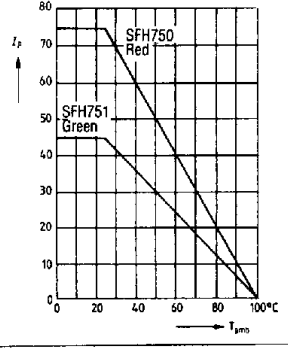

SFH450/750/751
Test Circuit for Switching Times

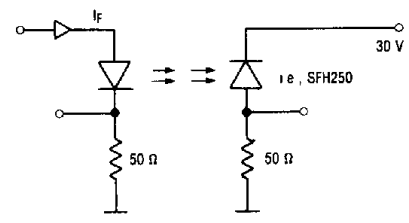

Fiber Optic Devices

SFH450

This datasheet has been downloaded from:

www.DatasheetCatalog.com

Datasheets for electronic components.