

The RF Sub-Micron MOSFET Line
RF Power Field Effect Transistor
N-Channel Enhancement-Mode Lateral MOSFET

Designed for broadband commercial and industrial applications at frequencies up to 1.0 GHz. The high gain and broadband performance of this device make it ideal for large-signal, common-source amplifier applications in 28 volt base station equipment.

- Typical Performance at 945 MHz, 28 Volts
Output Power – 45 Watts PEP
Power Gain – 18.5 dB
Efficiency – 41% (Two Tones)
IMD – -31 dBc
- Integrated ESD Protection
- Guaranteed Ruggedness @ Load VSWR = 5:1, @ 28 Vdc, 945 MHz, 45 Watts (CW) Output Power
- Excellent Thermal Stability
- Characterized with Series Equivalent Large-Signal Impedance Parameters
- Moisture Sensitivity Level 3
- RF Power Plastic Surface Mount Package
- Available in Tape and Reel. R1 Suffix = 500 Units per 24 mm, 13 inch Reel.

MRF9045M
MRF9045MR1

945 MHz, 45 W, 28 V
LATERAL N-CHANNEL
BROADBAND
RF POWER MOSFET

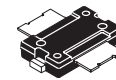

CASE 1265-06, STYLE 1
(TO-270)

PLASTIC

MAXIMUM RATINGS

Rating	Symbol	Value	Unit
Drain-Source Voltage	V_{DSS}	65	Vdc
Gate-Source Voltage	V_{GS}	+15, -0.5	Vdc
Total Device Dissipation @ $T_C = 25^\circ\text{C}$ Derate above 25°C	P_D	156(1) 1.25(1)	Watts W/°C
Storage Temperature Range	T_{stg}	-65 to +150	°C
Operating Junction Temperature	T_J	150	°C

ESD PROTECTION CHARACTERISTICS

Test Conditions	Class
Human Body Model	1 (Typical)
Machine Model	M2 (Typical)

THERMAL CHARACTERISTICS

Characteristic	Symbol	Max	Unit
Thermal Resistance, Junction to Case	$R_{\theta JC}$	0.8(1)	°C/W

(1) Simulated

NOTE – **CAUTION** – MOS devices are susceptible to damage from electrostatic charge. Reasonable precautions in handling and packaging MOS devices should be observed.

ELECTRICAL CHARACTERISTICS ($T_C = 25^\circ\text{C}$ unless otherwise noted)

Characteristic	Symbol	Min	Typ	Max	Unit
OFF CHARACTERISTICS					
Zero Gate Voltage Drain Leakage Current ($V_{DS} = 65\text{ Vdc}$, $V_{GS} = 0$)	I_{DSS}	—	—	10	μAdc
Zero Gate Voltage Drain Leakage Current ($V_{DS} = 28\text{ Vdc}$, $V_{GS} = 0$)	I_{DSS}	—	—	1	μAdc
Gate–Source Leakage Current ($V_{GS} = 5\text{ Vdc}$, $V_{DS} = 0$)	I_{GSS}	—	—	1	μAdc
ON CHARACTERISTICS					
Gate Threshold Voltage ($V_{DS} = 10\text{ Vdc}$, $I_D = 150\ \mu\text{Adc}$)	$V_{GS(th)}$	2	—	4	Vdc
Gate Quiescent Voltage ($V_{DS} = 28\text{ Vdc}$, $I_D = 350\text{ mAdc}$)	$V_{GS(Q)}$	—	3.7	—	Vdc
Drain–Source On–Voltage ($V_{GS} = 10\text{ Vdc}$, $I_D = 1\text{ Adc}$)	$V_{DS(on)}$	—	0.19	0.4	Vdc
Forward Transconductance ($V_{DS} = 10\text{ Vdc}$, $I_D = 3\text{ Adc}$)	g_{fs}	—	4	—	S
DYNAMIC CHARACTERISTICS					
Input Capacitance ($V_{DS} = 28\text{ Vdc}$, $V_{GS} = 0$, $f = 1\text{ MHz}$)	C_{iss}	—	74	—	pF
Output Capacitance ($V_{DS} = 28\text{ Vdc}$, $V_{GS} = 0$, $f = 1\text{ MHz}$)	C_{oss}	—	39	—	pF
Reverse Transfer Capacitance ($V_{DS} = 28\text{ Vdc}$, $V_{GS} = 0$, $f = 1\text{ MHz}$)	C_{rss}	—	1.9	—	pF

(continued)

ELECTRICAL CHARACTERISTICS — continued ($T_C = 25^\circ\text{C}$ unless otherwise noted)

Characteristic	Symbol	Min	Typ	Max	Unit
FUNCTIONAL TESTS (In Motorola Test Fixture)					
Two-Tone Common-Source Amplifier Power Gain ($V_{DD} = 28\text{ Vdc}$, $P_{Out} = 45\text{ W PEP}$, $I_{DQ} = 350\text{ mA}$, $f_1 = 945.0\text{ MHz}$, $f_2 = 945.1\text{ MHz}$)	G_{ps}	17	18.5	—	dB
Two-Tone Drain Efficiency ($V_{DD} = 28\text{ Vdc}$, $P_{Out} = 45\text{ W PEP}$, $I_{DQ} = 350\text{ mA}$, $f_1 = 945.0\text{ MHz}$, $f_2 = 945.1\text{ MHz}$)	η	38	41	—	%
3rd Order Intermodulation Distortion ($V_{DD} = 28\text{ Vdc}$, $P_{Out} = 45\text{ W PEP}$, $I_{DQ} = 350\text{ mA}$, $f_1 = 945.0\text{ MHz}$, $f_2 = 945.1\text{ MHz}$)	IMD	—	-31	-28	dBc
Input Return Loss ($V_{DD} = 28\text{ Vdc}$, $P_{Out} = 45\text{ W PEP}$, $I_{DQ} = 350\text{ mA}$, $f_1 = 945.0\text{ MHz}$, $f_2 = 945.1\text{ MHz}$)	IRL	9	15	—	dB
Two-Tone Common-Source Amplifier Power Gain ($V_{DD} = 28\text{ Vdc}$, $P_{Out} = 45\text{ W PEP}$, $I_{DQ} = 350\text{ mA}$, $f_1 = 930.0\text{ MHz}$, $f_2 = 930.1\text{ MHz}$ and $f_1 = 960.0\text{ MHz}$, $f_2 = 960.1\text{ MHz}$)	G_{ps}	—	18.5	—	dB
Two-Tone Drain Efficiency ($V_{DD} = 28\text{ Vdc}$, $P_{Out} = 45\text{ W PEP}$, $I_{DQ} = 350\text{ mA}$, $f_1 = 930.0\text{ MHz}$, $f_2 = 930.1\text{ MHz}$ and $f_1 = 960.0\text{ MHz}$, $f_2 = 960.1\text{ MHz}$)	η	—	41	—	%
3rd Order Intermodulation Distortion ($V_{DD} = 28\text{ Vdc}$, $P_{Out} = 45\text{ W PEP}$, $I_{DQ} = 350\text{ mA}$, $f_1 = 930.0\text{ MHz}$, $f_2 = 930.1\text{ MHz}$ and $f_1 = 960.0\text{ MHz}$, $f_2 = 960.1\text{ MHz}$)	IMD	—	-31	—	dBc
Input Return Loss ($V_{DD} = 28\text{ Vdc}$, $P_{Out} = 45\text{ W PEP}$, $I_{DQ} = 350\text{ mA}$, $f_1 = 930.0\text{ MHz}$, $f_2 = 930.1\text{ MHz}$ and $f_1 = 960.0\text{ MHz}$, $f_2 = 960.1\text{ MHz}$)	IRL	—	13	—	dB

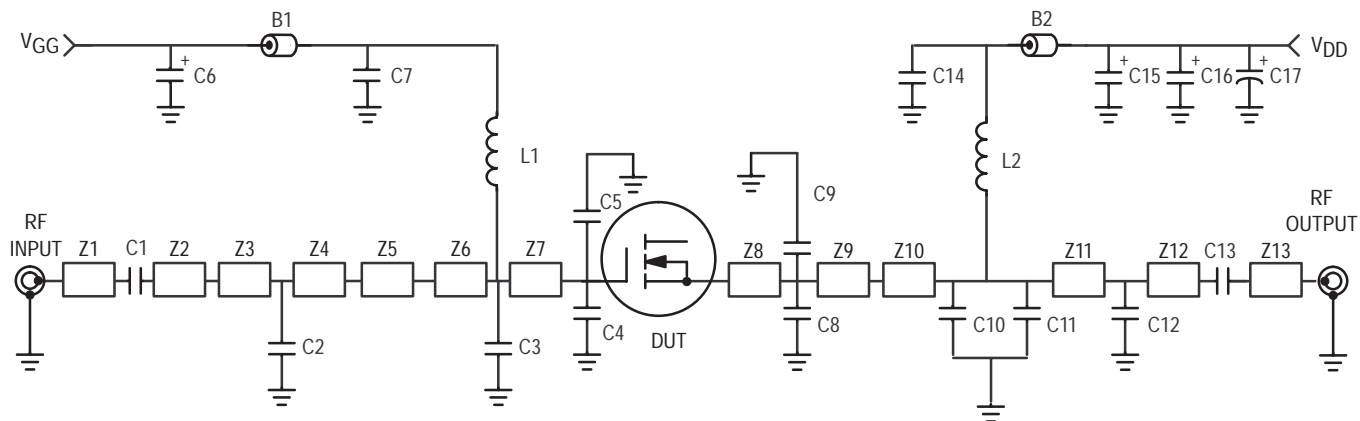

B1, B2	Short Ferrite Beads, Surface Mount	Z3	0.14" x 0.32"
C1, C7, C13, C14	47 pF, Chip Capacitors, B Case	Z4	0.47" x 0.32"
C2, C8	2.7 pF, Chip Capacitors, B Case	Z5	0.16" x 0.32" x 0.62" Tapered
C3	3.9 pF, Chip Capacitor, B Case	Z6	0.18" x 0.62"
C4, C5, C8, C9	10 pF, Chip Capacitors, B Case	Z7	0.56" x 0.62"
C6	10 μ F, 35 V Tantalum Surface Mount Capacitor	Z8	0.33" x 0.32"
C10	2.2 pF, Chip Capacitor, B Case	Z9	0.14" x 0.32"
C11	4.7 pF, Chip Capacitor, B Case	Z10	0.36" x 0.08"
C12	1.2 pF, Chip Capacitor, B Case	Z11	1.01" x 0.08"
C17	220 μ F, 50 V Electrolytic Capacitor	Z12	0.15" x 0.08"
L1, L2	12.5 nH, Inductors	Z13	0.29" x 0.08"
Z1	0.20" x 0.08"		
Z2	0.57" x 0.12"		

Figure 1. 945 MHz Broadband Test Circuit Schematic

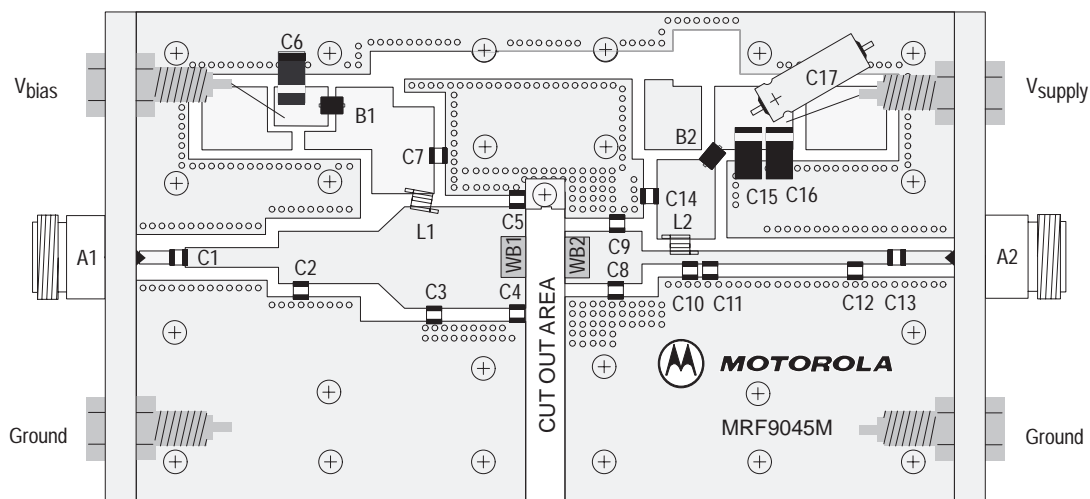

Figure 2. 945 MHz Broadband Test Circuit Components Layout

TYPICAL CHARACTERISTICS

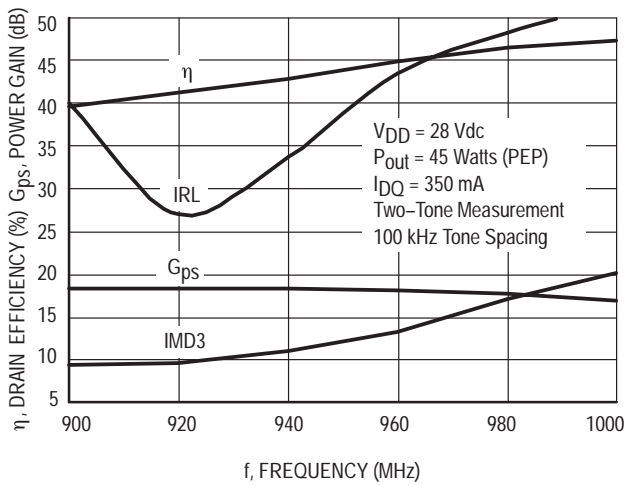

Figure 3. Class AB Test Circuit Performance

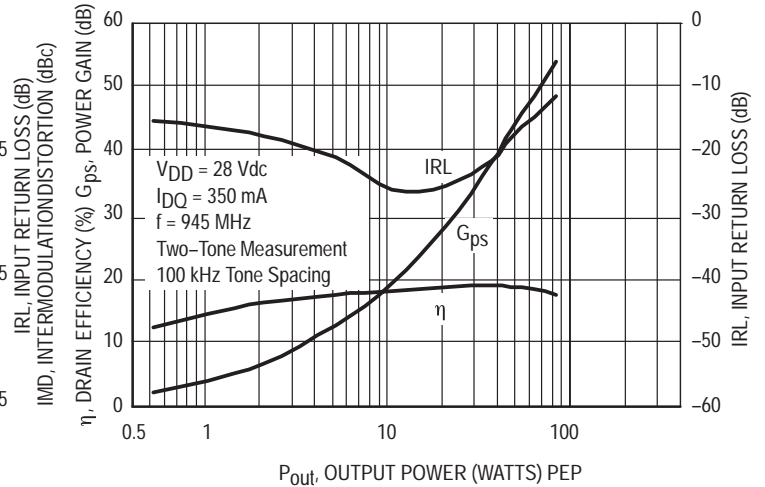

Figure 4. Power Gain, Efficiency and IRL versus Output Power

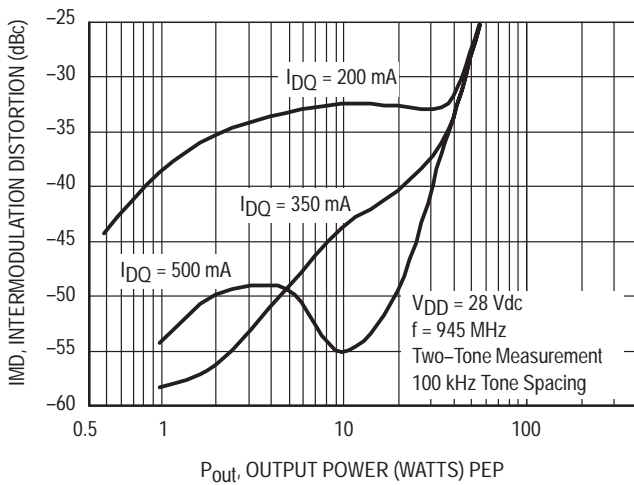

Figure 5. Intermodulation Distortion versus Output Power

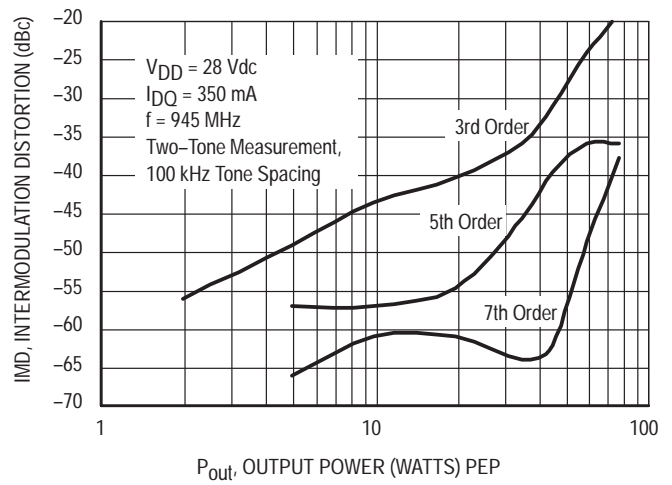

Figure 6. Intermodulation Distortion Products versus Output Power

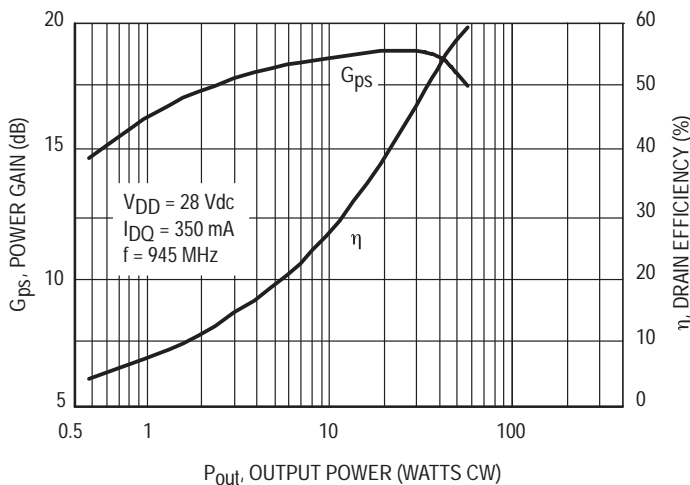

Figure 7. CW Power Gain and Drain Efficiency versus Output Power

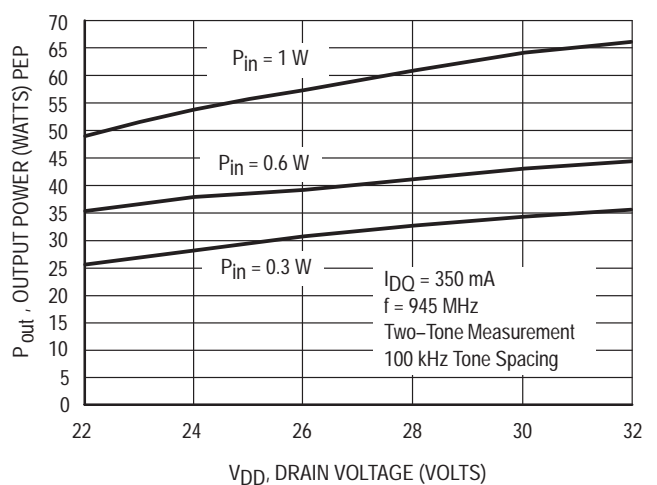
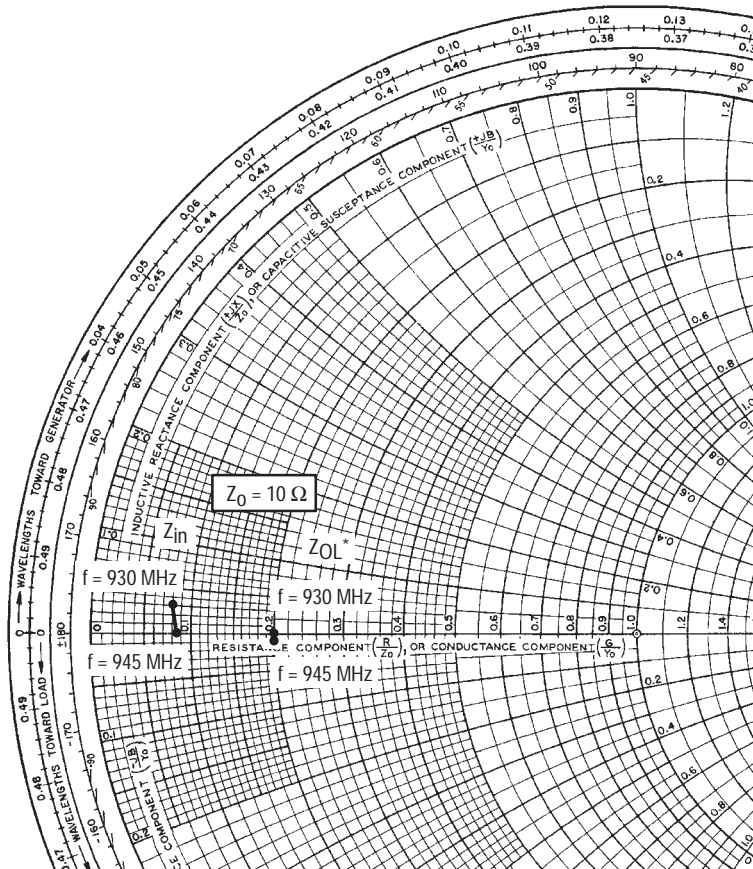

Figure 8. Output Voltage versus Supply Voltage



$V_{DD} = 28\text{ V}$, $I_{DQ} = 350\text{ mA}$, $P_{out} = 45\text{ W (PEP)}$

f MHz	Z_{in} Ω	Z_{OL}^* Ω
930	$0.81 + j0.25$	$2.03 - j0.09$
945	$0.85 + j0.05$	$2.03 - j0.28$

Z_{in} = Complex conjugate of source impedance.

Z_{OL}^* = Complex conjugate of the optimum load impedance at a given output power, voltage, IMD, bias current and frequency.

Note: Z_{OL}^* was chosen based on tradeoffs between gain, output power, drain efficiency and intermodulation distortion.

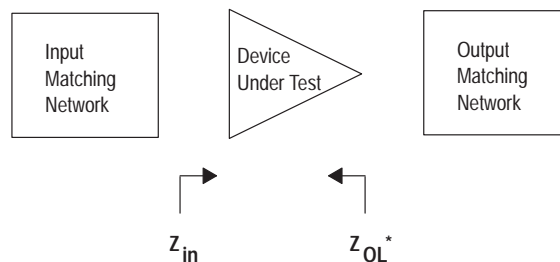
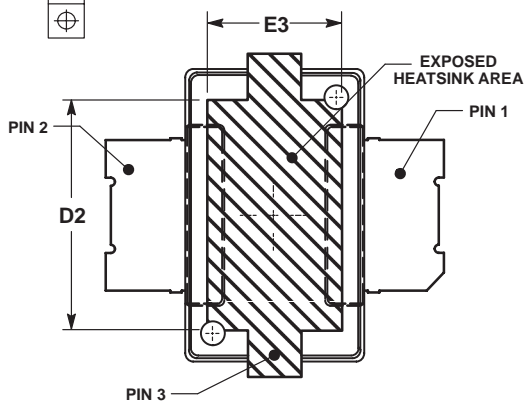
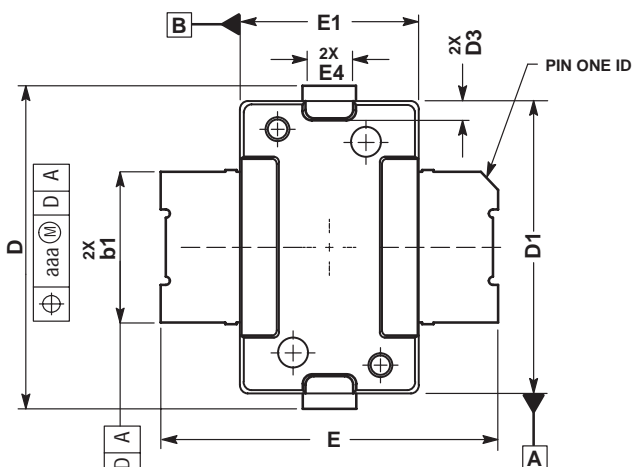
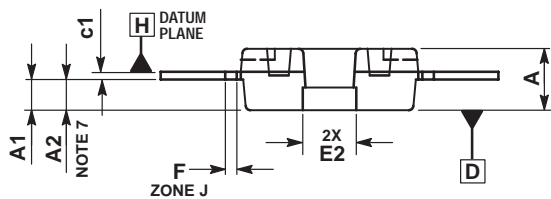

Figure 9. Series Equivalent Input and Output Impedance

PACKAGE DIMENSIONS



BOTTOM VIEW



NOTES:

1. CONTROLLING DIMENSION: INCH.
2. INTERPRET DIMENSIONS AND TOLERANCES PER ASME Y14.5M-1994.
3. DATUM PLANE -H- IS LOCATED AT TOP OF LEAD AND IS COINCIDENT WITH THE LEAD WHERE THE LEAD EXITS THE PLASTIC BODY AT THE TOP OF THE PARTING LINE.
4. DIMENSIONS "D1" AND "E1" DO NOT INCLUDE MOLD PROTRUSION. ALLOWABLE PROTRUSION IS .006 PER SIDE. DIMENSIONS "D1" AND "E1" DO INCLUDE MOLD MISMATCH AND ARE DETERMINED AT DATUM PLANE -H-.
5. DIMENSION b1 DOES NOT INCLUDE DAMBAR PROTRUSION. ALLOWABLE DAMBAR PROTRUSION SHALL BE .005 TOTAL IN EXCESS OF THE b1 DIMENSION AT MAXIMUM MATERIAL CONDITION.
6. DATUMS -A- AND -B- TO BE DETERMINED AT DATUM PLANE -H-.
7. DIMENSION A2 APPLIES WITHIN ZONE "J" ONLY.

DIM	INCHES		MILLIMETERS	
	MIN	MAX	MIN	MAX
A	.076	.084	1.93	2.13
A1	.038	.044	0.96	1.12
A2	.040	.042	1.02	1.07
D	.416	.424	10.57	10.77
D1	.376	.384	9.55	9.75
D2	.290	.320	7.37	8.13
D3	.016	.024	0.41	0.61
E	.436	.444	11.07	11.28
E1	.236	.244	5.99	6.20
E2	.066	.074	1.68	1.88
E3	.150	.180	3.81	4.57
E4	.058	.066	1.47	1.68
F	.025 BSC		0.64 BSC	
b1	.193	.199	4.90	5.06
c1	.007	.011	0.18	0.28
aaa	.004		0.10	

STYLE 1:

1. DRAIN
2. GATE
3. SOURCE

**CASE 1265-06
ISSUE E
(TO-270)**

Motorola reserves the right to make changes without further notice to any products herein. Motorola makes no warranty, representation or guarantee regarding the suitability of its products for any particular purpose, nor does Motorola assume any liability arising out of the application or use of any product or circuit, and specifically disclaims any and all liability, including without limitation consequential or incidental damages. "Typical" parameters which may be provided in Motorola data sheets and/or specifications can and do vary in different applications and actual performance may vary over time. All operating parameters, including "Typicals" must be validated for each customer application by customer's technical experts. Motorola does not convey any license under its patent rights nor the rights of others. Motorola products are not designed, intended, or authorized for use as components in systems intended for surgical implant into the body, or other applications intended to support or sustain life, or for any other application in which the failure of the Motorola product could create a situation where personal injury or death may occur. Should Buyer purchase or use Motorola products for any such unintended or unauthorized application, Buyer shall indemnify and hold Motorola and its officers, employees, subsidiaries, affiliates, and distributors harmless against all claims, costs, damages, and expenses, and reasonable attorney fees arising out of, directly or indirectly, any claim of personal injury or death associated with such unintended or unauthorized use, even if such claim alleges that Motorola was negligent regarding the design or manufacture of the part. Motorola and  are registered trademarks of Motorola, Inc. Motorola, Inc. is an Equal Opportunity/Affirmative Action Employer.

How to reach us:

USA/EUROPE/Locations Not Listed: Motorola Literature Distribution; P.O. Box 5405, Denver, Colorado 80217. 1-303-675-2140 or 1-800-441-2447

JAPAN: Motorola Japan Ltd.; SPS, Technical Information Center, 3-20-1, Minami-Azabu. Minato-ku, Tokyo 106-8573 Japan. 81-3-3440-3569

ASIA/PACIFIC: Motorola Semiconductors H.K. Ltd.; Silicon Harbour Centre, 2 Dai King Street, Tai Po Industrial Estate, Tai Po, N.T., Hong Kong. 852-26668334

Technical Information Center: 1-800-521-6274

HOME PAGE: <http://www.motorola.com/semiconductors/>



MOTOROLA

MRF9045M/D