

The RF Line
NPN Silicon
High-Frequency Transistor

Designed primarily for use in high-gain, low-noise small-signal amplifiers for operation up to 2.5 GHz. Also usable in applications requiring fast switching times.

- High Current-Gain — Bandwidth Product
- Low Noise Figure @ $f = 1.0$ GHz —
 $NF_{(matched)} = 1.8$ dB (Typ) (MRF9011LT1)
 $= 1.9$ dB (Typ) (MMBR901LT1, T3)
- High Power Gain —
 $G_{pe(matched)} = 13.5$ dB (Typ) @ $f = 1.0$ GHz (MRF9011LT1)
 $= 12.0$ dB (Typ) @ $f = 1.0$ GHz (MMBR901LT1, T3)
- Guaranteed RF Parameters (MRF9011LT1)
- Surface Mounted SOT-23 & SOT-143 Offer Improved RF Performance
 Lower Package Parasitics
 High Gain
- Available in tape and reel packaging options:
 T1 suffix = 3,000 units per reel
 T3 suffix = 10,000 units per reel

MAXIMUM RATINGS

Rating	Symbol	Value	Unit
Collector-Emitter Voltage	V_{CEO}	15	Vdc
Collector-Base Voltage	V_{CBO}	25	Vdc
Emitter-Base Voltage	V_{EBO}	2.0	Vdc
Collector Current — Continuous	I_C	30	mA _{dc}
Power Dissipation @ $T_C = 75^\circ\text{C}$ (1) MMBR901LT1, T3; MRF9011LT1	$P_{D(max)}$	0.300	Watt
Derate above 25°C		4.00	mW/ $^\circ\text{C}$
Total Device Dissipation @ $T_C = 75^\circ\text{C}$ (1) Derate above 75°C MPS901	P_D	300 4.0	mW mW/ $^\circ\text{C}$
Total Device Dissipation @ $T_C = 75^\circ\text{C}$ (1) Derate above 75°C MRF901	P_D	0.375 5.0	Watt mW/ $^\circ\text{C}$
Storage Temperature Range All	T_{stg}	-55 to +150	$^\circ\text{C}$
Maximum Junction Temperature	$T_{J(max)}$	150	$^\circ\text{C}$

THERMAL CHARACTERISTICS

Characteristic	Symbol	Max	Unit
Storage Temperature	T_{stg}	150	$^\circ\text{C}$
Thermal Resistance, Junction to Case MRF901 MRF9011LT1, MMBR901LT1, T3	$R_{\theta JC}$	200 250	$^\circ\text{C}/\text{W}$

DEVICE MARKING

MRF9011LT1 = 01	MMBR901LT1, T3 = 7A
-----------------	---------------------

NOTE:

1. Case temperature measured on collector lead immediately adjacent to body of package.

MMBR901LT1, T3
MPS901 MRF901
MRF9011LT1

$I_C = 30$ mA
SURFACE MOUNTED
HIGH-FREQUENCY
TRANSISTOR
NPN SILICON



CASE 318-08, STYLE 6
SOT-23
LOW PROFILE, MMBR901LT1, T3



CASE 29-04, STYLE 2
TO-226AA (TO-92)
MPS901



CASE 317-01, STYLE 2
MRF901

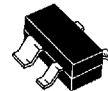

CASE 318A-05, STYLE 1
SOT-143
LOW PROFILE, MRF9011LT1

ELECTRICAL CHARACTERISTICS ($T_A = 25^\circ\text{C}$ unless otherwise noted)

Characteristic	Symbol	Min	Typ	Max	Unit
OFF CHARACTERISTICS					
Collector-Emitter Breakdown Voltage ($I_C = 1.0 \text{ mA}$, $I_B = 0$)	$V_{(BR)CEO}$	15	—	—	Vdc
Collector-Base Breakdown Voltage ($I_C = 0.1 \text{ mA}$, $I_E = 0$)	$V_{(BR)CBO}$	25	—	—	Vdc
Emitter-Base Breakdown Voltage ($I_E = 0.1 \text{ mA}$, $I_C = 0$)	$V_{(BR)EBO}$	2.0	—	—	Vdc
Collector Cutoff Current ($V_{CB} = 15 \text{ Vdc}$, $I_E = 0$)	I_{CBO}	—	—	50	nAdc

ON CHARACTERISTICS

DC Current Gain ($I_C = 5.0 \text{ mA}$, $V_{CE} = 5.0 \text{ Vdc}$)	MMBR901LT1, T3 MRF9011LT1, MPS901, MRF901	h_{FE}	50 30	— 80	200 200	—
--	--	----------	----------	---------	------------	---

DYNAMIC CHARACTERISTICS

Current-Gain — Bandwidth Product ($I_C = 15 \text{ mA}$, $V_{CE} = 10 \text{ Vdc}$, $f = 1.0 \text{ GHz}$)	MRF9011LT1 MPS901, MRF901	f_T	— —	3.8 4.5	— —	GHz
Collector-Base Capacitance ($V_{CB} = 10 \text{ Vdc}$, $I_E = 0$, $f = 1.0 \text{ MHz}$)	MRF9011LT1 MPS901 MRF901	C_{cb}	— — —	0.55 0.50 0.40	1.0 1.0 1.0	pF

FUNCTIONAL TESTS

Power Gain at Minimum Noise Figure ($V_{CE} = 10 \text{ Vdc}$, $I_C = 5.0 \text{ mA}$, $f = 1.0 \text{ GHz}$)	MRF9011LT1	GNF_{min}	—	13.5	—	dB
Minimum Noise Figure (Figure 3) ($V_{CE} = 10 \text{ Vdc}$, $I_C = 5.0 \text{ mA}$, $f = 1.0 \text{ GHz}$)	MRF9011LT1	NF_{min}	—	1.8	—	dB
Insertion Gain in 50 Ω System ($V_{CE} = 10 \text{ Vdc}$, $I_C = 5.0 \text{ mA}$, $f = 1.0 \text{ GHz}$)	MRF9011LT1	$ S_{21} ^2$	9.0	10.2	—	dB
Minimum Noise Figure (Figure 3) ($V_{CE} = 6.0 \text{ Vdc}$, $I_C = 5.0 \text{ mA}$, $f = 1.0 \text{ GHz}$) ($V_{CE} = 10 \text{ Vdc}$, $I_C = 5.0 \text{ mA}$, $f = 1.0 \text{ GHz}$)	MMBR901LT1, T3	NF_{min}	—	1.9	—	dB
Minimum Noise Figure (Figure 3) ($I_C = 5.0 \text{ mA}$, $V_{CE} = 10 \text{ Vdc}$, $f = 900 \text{ MHz}$)	MPS901	NF_{min}	—	2.4	—	dB
Minimum Noise Figure (Figure 3) ($I_C = 5.0 \text{ mA}$, $V_{CE} = 6.0 \text{ Vdc}$, $f = 1.0 \text{ GHz}$)	MRF901	NF_{min}	—	2.0	2.5	dB

SMALL-SIGNAL CHARACTERISTICS

Output Capacitance ($V_{CB} = 10 \text{ Vdc}$, $I_C = 5.0 \text{ mA}$, $f = 1.0 \text{ GHz}$)	MMBR901LT1	C_{obo}	—	—	1.0	pF
Common-Emitter Amplifier Gain ($V_{CC} = 6.0 \text{ Vdc}$, $I_C = 5.0 \text{ mA}$, $f = 1.0 \text{ GHz}$)	MMBR901LT1	G_{pe}	—	12	—	dB

MRF9011LT1

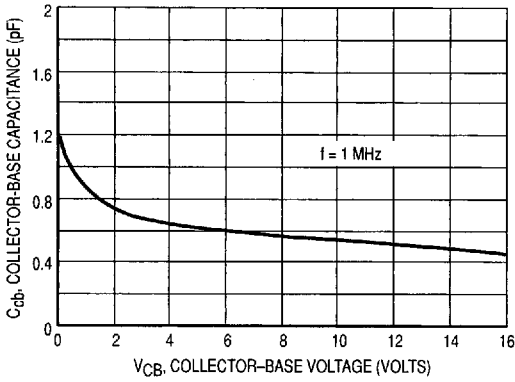

Figure 1. Collector-Base Capacitance versus Collector-Base Voltage

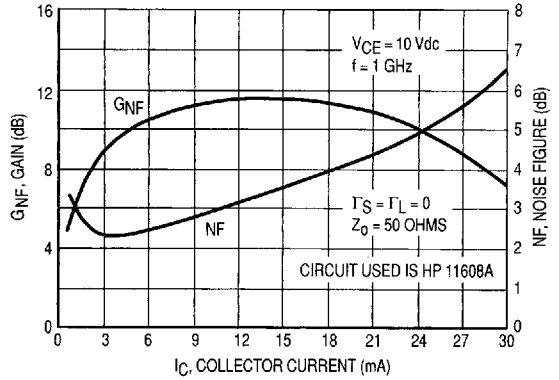

Figure 2. Gain and Noise Figure versus Collector Current

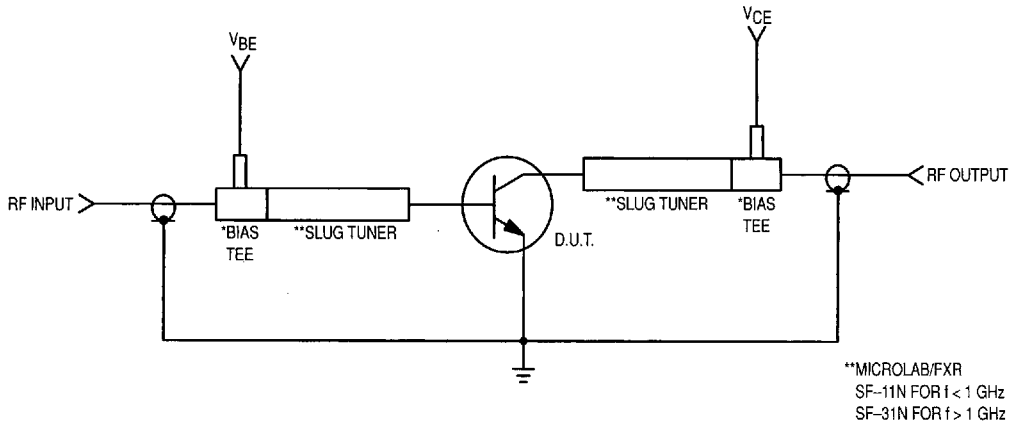

Figure 3. MRF9011LT1 Functional Circuit Schematic

MRF9011LT1

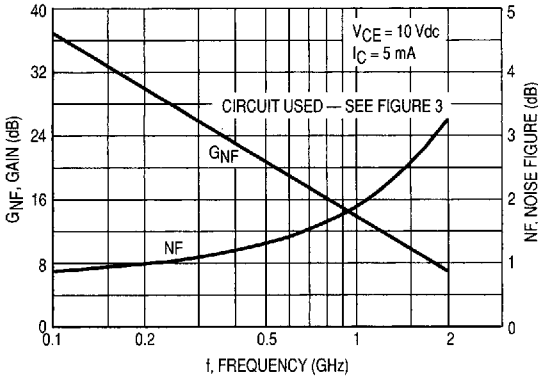

Figure 4. Gain and Noise Figure versus Frequency

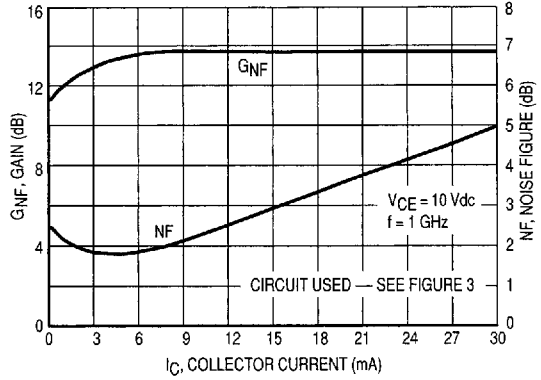

Figure 5. Gain and Noise Figure versus Collector Current

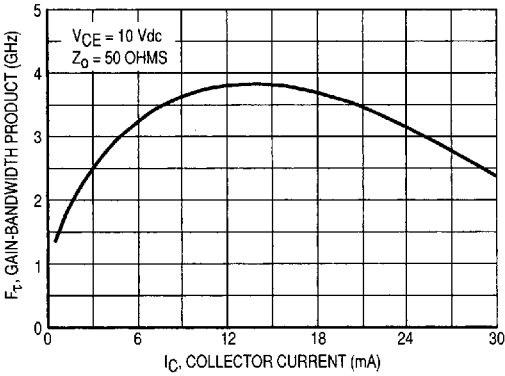

Figure 6. Gain-Bandwidth Product versus Collector Current

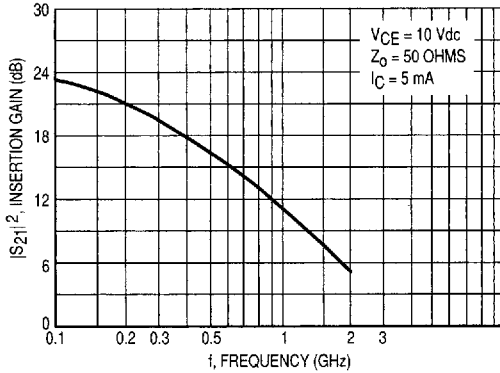

Figure 7. Insertion Gain versus Frequency

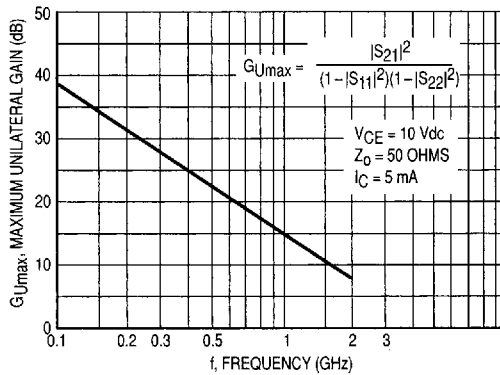

Figure 8. Maximum Unilateral Gain versus Frequency

V _{CE} (Vdc)	I _C (mA)	f (MHz)	S ₁₁		S ₂₁		S ₁₂		S ₂₂	
			S ₁₁	∠φ	S ₂₁	∠φ	S ₁₂	∠φ	S ₂₂	∠φ
5.0	5.0	100	0.85	-41	13.64	153	0.03	65	0.93	-17
		200	0.78	-76	10.77	134	0.05	54	0.80	-29
		500	0.71	-131	6.10	102	0.08	35	0.55	-42
		1000	0.66	-169	3.22	77	0.08	33	0.45	-48
		2000	0.60	152	1.65	47	0.11	46	0.47	-63
	10	100	0.72	-59	20.01	145	0.03	62	0.87	-23
		200	0.70	-100	14.31	123	0.04	49	0.67	-36
		500	0.66	-150	7.03	94	0.06	38	0.44	-43
		1000	0.63	179	3.57	73	0.07	45	0.37	-46
		2000	0.58	147	1.79	46	0.11	57	0.41	-60
	15	100	0.65	-75	23.44	138	0.02	57	0.81	-27
		200	0.66	-118	15.56	116	0.04	46	0.59	-38
		500	0.65	-159	7.10	90	0.05	42	0.40	-40
		1000	0.63	174	3.57	71	0.06	52	0.35	-43
		2000	0.59	144	1.77	45	0.11	62	0.40	-58
	20	100	0.61	-89	24.32	133	0.02	51	0.77	-28
		200	0.66	-130	15.11	111	0.03	43	0.55	-35
		500	0.66	-166	6.68	88	0.04	46	0.41	-34
		1000	0.65	171	3.32	69	0.06	56	0.39	-39
		2000	0.61	143	1.65	43	0.10	65	0.44	-56
30	100	0.63	-132	13.18	118	0.02	47	0.72	-15	
	200	0.68	-157	7.07	104	0.02	44	0.66	-16	
	500	0.69	-177	3.23	90	0.03	55	0.62	-24	
	1000	0.70	165	1.78	71	0.05	65	0.59	-38	
	2000	0.66	138	0.93	42	0.09	79	0.62	-62	
10	5.0	100	0.85	-38	13.67	155	0.03	70	0.93	-14
		200	0.80	-71	10.97	136	0.05	56	0.83	-24
		500	0.70	-126	6.35	104	0.07	37	0.60	-35
		1000	0.65	-166	3.39	78	0.07	36	0.51	-40
		2000	0.58	154	1.74	48	0.10	50	0.54	-55
	10	100	0.75	-55	20.12	147	0.02	66	0.88	-19
		200	0.71	-94	14.60	125	0.04	50	0.72	-30
		500	0.65	-145	7.33	96	0.05	39	0.50	-35
		1000	0.62	-177	3.74	74	0.06	46	0.45	-38
		2000	0.57	149	1.88	47	0.10	60	0.49	-53
	15	100	0.68	-68	23.53	140	0.02	61	0.85	-22
		200	0.67	-110	15.90	119	0.03	49	0.65	-31
		500	0.64	-155	7.45	92	0.04	42	0.47	-32
		1000	0.62	177	3.74	71	0.06	53	0.44	-35
		2000	0.58	146	1.90	45	0.09	65	0.50	-51
	20	100	0.64	-79	24.77	135	0.02	56	0.81	-23
		200	0.64	-122	15.81	114	0.03	46	0.62	-29
		500	0.64	-161	7.10	89	0.04	46	0.48	-28
		1000	0.62	174	3.53	79	0.05	56	0.46	-33
		2000	0.59	145	1.75	44	0.09	68	0.53	-50
30	100	0.61	-114	16.25	123	0.01	48	0.79	-15	
	200	0.63	-147	9.10	107	0.02	49	0.71	-15	
	500	0.65	-172	4.22	90	0.03	53	0.66	-22	
	1000	0.66	168	2.27	71	0.05	63	0.63	-33	
	2000	0.63	140	1.15	41	0.08	79	0.67	-53	

Table 1. MRF9011LT1 Common Emitter S-Parameters

MPS901

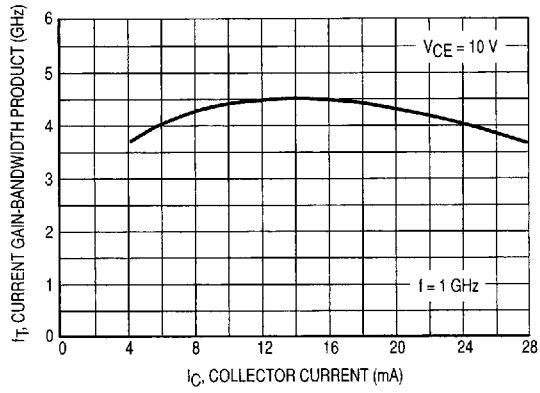

Figure 9. Current Gain–Bandwidth Product versus Collector Current

MPS901

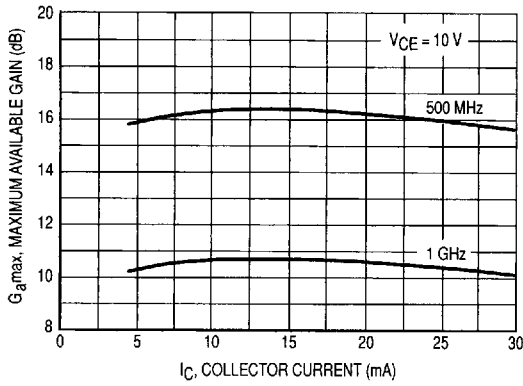

Figure 10. Maximum Available Gain versus Collector Current

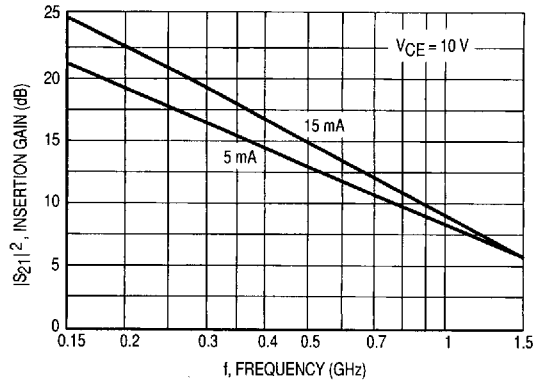

Figure 11. $|S_{21}|^2$ versus Frequency

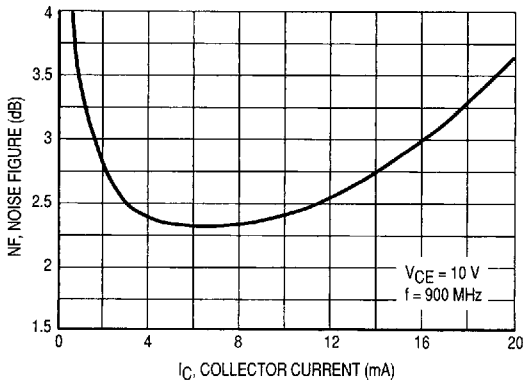

Figure 12. Noise Figure versus Collector Current

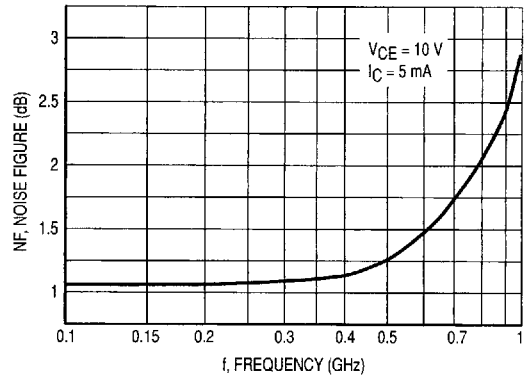

Figure 13. Noise Figure versus Frequency

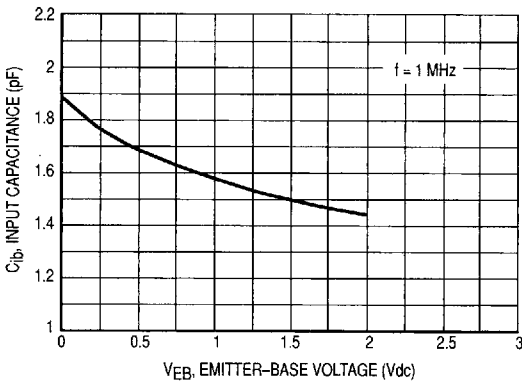

Figure 14. Input Capacitance versus Emitter-Base Voltage

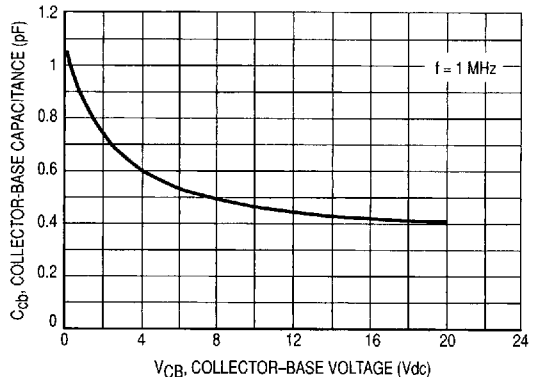

Figure 15. Collector-Base Capacitance versus Collector-Base Voltage

MPS901

V _{CE} (Volts)	I _C (mA)	f (MHz)	S ₁₁		S ₂₁		S ₁₂		S ₂₂	
			S ₁₁	∠φ	S ₂₁	∠φ	S ₁₂	∠φ	S ₂₂	∠φ
5.0	5.0	100	0.76	-35	9.42	142	0.03	67	0.85	-18
		200	0.60	-63	7.98	122	0.05	58	0.70	-26
		500	0.28	-127	4.79	84	0.09	55	0.53	-35
		1000	0.27	148	2.71	50	0.15	51	0.42	-51
		1500	0.43	113	2.02	23	0.21	42	0.28	-79
	10	100	0.57	-51	14.80	131	0.03	65	0.75	-22
		200	0.36	-87	10.80	108	0.04	62	0.60	-26
		500	0.18	-151	5.23	77	0.08	62	0.48	-31
		1000	0.25	136	2.86	47	0.15	55	0.39	-48
		1500	0.42	109	2.12	22	0.22	42	0.25	-75
	15	100	0.42	-67	17.80	123	0.02	66	0.69	-22
		200	0.26	-105	11.50	101	0.04	66	0.56	-23
		500	0.17	-169	5.27	74	0.08	66	0.47	-28
		1000	0.26	131	2.86	46	0.15	57	0.39	-47
		1500	0.43	108	2.12	21	0.22	44	0.25	-73
	20	100	0.33	-82	18.66	117	0.02	67	0.66	-21
		200	0.22	-120	11.54	98	0.03	68	0.55	-21
		500	0.17	-171	5.16	72	0.08	67	0.48	-27
		1000	0.28	129	2.80	45	0.15	58	0.40	-45
		1500	0.45	107	2.07	19	0.22	45	0.27	-71
25	100	0.28	-103	18.11	113	0.02	68	0.64	-20	
	200	0.22	-138	11.03	95	0.03	70	0.55	-19	
	500	0.20	169	4.94	71	0.08	68	0.50	-25	
	1000	0.32	128	2.68	43	0.15	60	0.42	-44	
	1500	0.49	106	1.98	17	0.22	47	0.30	-71	
30	100	0.31	-127	16.10	109	0.02	67	0.64	-16	
	200	0.28	-156	9.69	93	0.03	70	0.57	-16	
	500	0.28	160	4.32	69	0.07	70	0.53	-25	
	1000	0.39	125	2.37	41	0.14	63	0.46	-44	
	1500	0.55	104	1.73	15	0.21	51	0.34	-72	

Table 2. MPS901 Common Emitter S-Parameters, V_{CE} = 5.0 V

V _{CE} (Volts)	I _C (mA)	f (MHz)	S ₁₁		S ₂₁		S ₁₂		S ₂₂	
			S ₁₁	∠φ	S ₂₁	∠φ	S ₁₂	∠φ	S ₂₂	∠φ
10	5.0	100	0.79	-33	9.36	144	0.03	68	0.88	-15
		200	0.63	-58	7.97	124	0.04	58	0.74	-22
		500	0.28	-117	4.87	86	0.07	57	0.60	-31
		1000	0.23	153	2.80	53	0.13	56	0.50	-46
		1500	0.38	116	2.09	26	0.19	48	0.38	-69
	10	100	0.60	-48	14.87	132	0.02	66	0.79	-18
		200	0.39	-79	11.06	110	0.03	63	0.65	-21
		500	0.16	-135	5.38	79	0.07	64	0.56	-28
		1000	0.20	138	2.97	50	0.13	59	0.47	-44
		1500	0.37	111	2.21	25	0.20	49	0.36	-66
	15	100	0.46	-61	18.20	124	0.02	66	0.74	-18
		200	0.28	-94	11.94	102	0.03	66	0.62	-19
		500	0.14	-154	5.45	76	0.07	67	0.55	-26
		1000	0.22	131	2.97	48	0.13	61	0.48	-42
		1500	0.38	109	2.21	24	0.20	50	0.36	-64
	20	100	0.37	-72	19.38	119	0.02	67	0.71	-17
		200	0.23	-105	11.97	99	0.03	68	0.61	-18
		500	0.14	-172	5.36	74	0.07	69	0.56	-24
		1000	0.23	128	2.91	47	0.13	62	0.48	-41
		1500	0.40	108	2.16	22	0.20	51	0.37	-64
	25	100	0.32	-86	19.40	115	0.02	68	0.70	-16
		200	0.22	-119	11.67	97	0.03	69	0.61	-16
		500	0.19	-176	5.28	74	0.06	70	0.57	-23
		1000	0.26	127	2.82	46	0.13	63	0.50	-41
		1500	0.43	107	2.09	21	0.19	53	0.40	-63
	30	100	0.29	-103	18.29	112	0.02	68	0.70	-14
		200	0.22	-135	10.86	95	0.03	70	0.62	-15
		500	0.20	165	4.82	72	0.06	72	0.59	-22
		1000	0.31	125	2.63	44	0.12	66	0.53	-41
		1500	0.47	106	1.95	19	0.19	55	0.43	-64

Table 3. MPS901 Common Emitter S-Parameters, V_{CE} = 10 V

MRF901

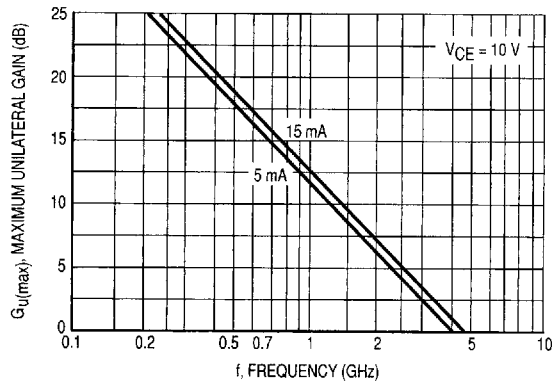

Figure 16. Maximum Unilateral Gain versus Frequency

MRF901

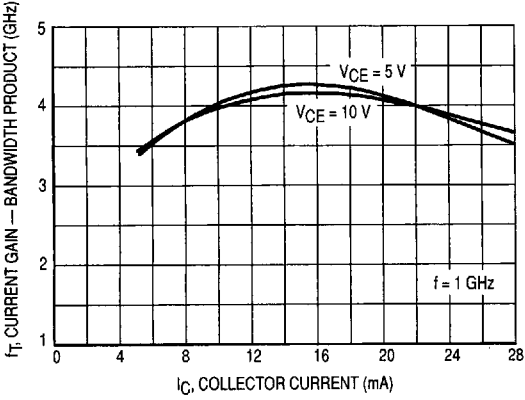

Figure 17. Current Gain — Bandwidth Product versus Collector Current

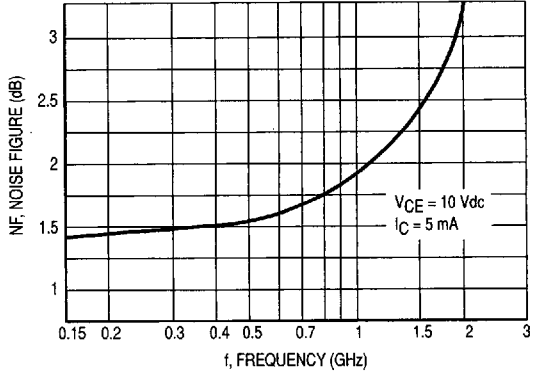

Figure 18. Noise Figure versus Frequency

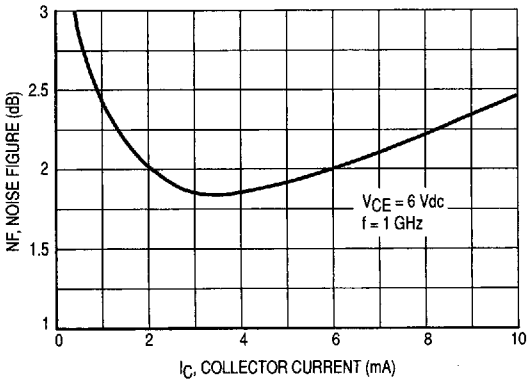

Figure 19. Noise Figure versus Collector Current

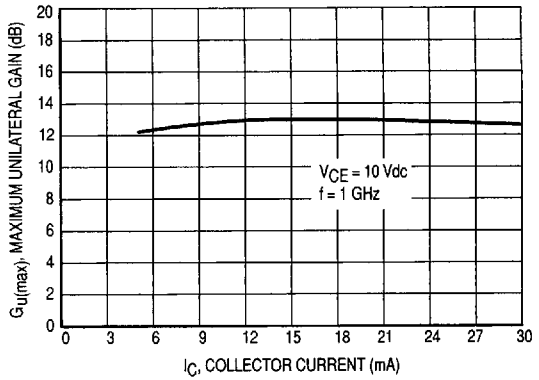

Figure 20. Maximum Unilateral Gain versus Collector Current

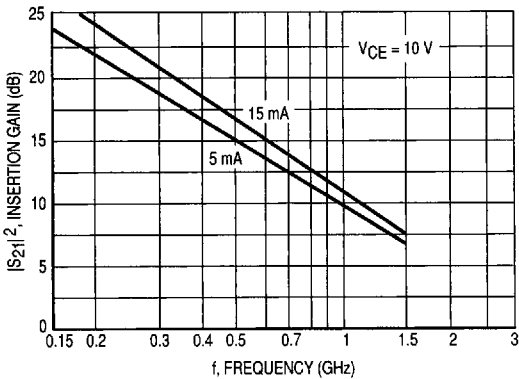

Figure 21. $|S_{21}|^2$ versus Frequency

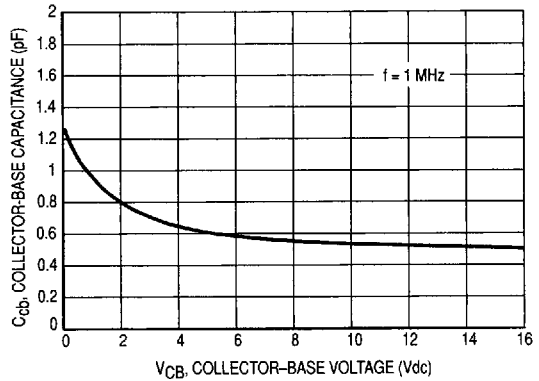

Figure 22. Collector-Base Capacitance versus Collector-Base Voltage

MRF901

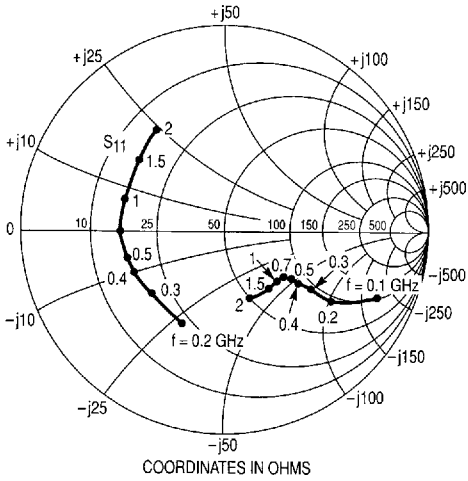

Figure 23. Input and Output Reflection Coefficients versus Frequency ($V_{CE} = 10\text{ V}$, $I_C = 15\text{ mA}$)

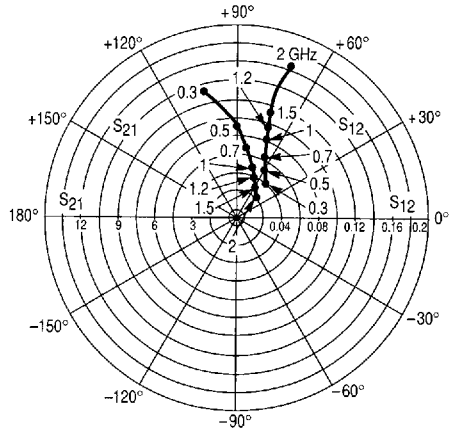

Figure 24. Forward/Reverse Transmission Coefficients versus Frequency ($V_{CE} = 10\text{ V}$, $I_C = 15\text{ mA}$)

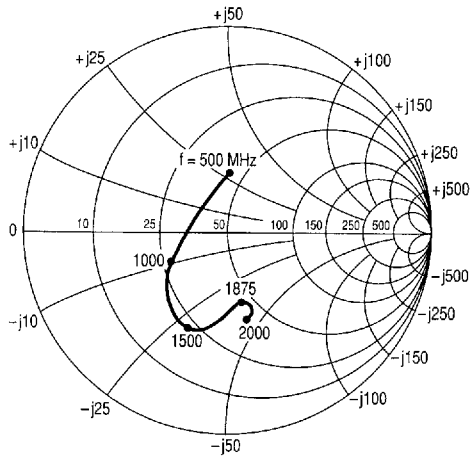

Figure 25. Source Impedance (Γ_{ms}) for Optimum Noise Figure versus Frequency ($V_{CE} = 10\text{ V}$, $I_C = 5.0\text{ mA}$)

MRF901

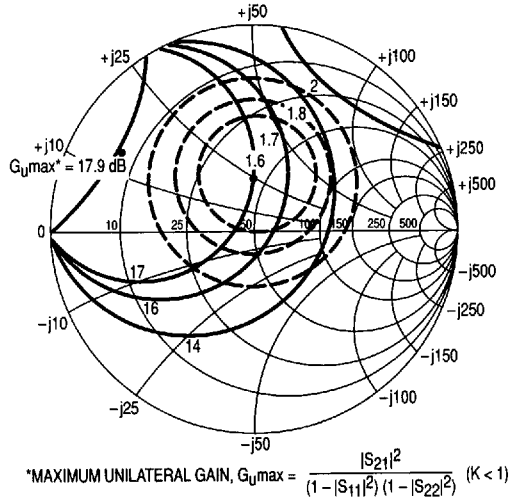

Figure 26. Constant Gain and Noise Figure Contours
(VCE = 10 Vdc, IC = 5.0 mA, f = 500 MHz)

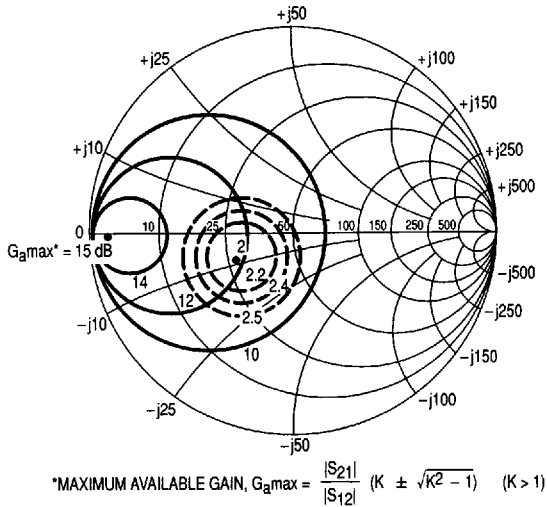

Figure 27. Constant Gain and Noise Figure Contours
(VCE = 10 Vdc, IC = 5.0 mA, f = 1.0 GHz)

MRF901

VCE (Volts)	IC (mA)	f (MHz)	S11		S21		S12		S22	
			S11	∠φ	S21	∠φ	S12	∠φ	S22	∠φ
5.0	5.0	100	0.71	-38	11.30	153	0.03	68	0.92	-17
		200	0.62	-75	9.48	133	0.05	55	0.76	-29
		500	0.54	-141	5.40	100	0.07	43	0.48	-44
		1000	0.53	178	2.93	76	0.09	48	0.40	-56
		2000	0.59	130	1.51	48	0.16	62	0.35	-85
	10	100	0.57	-58	16.95	145	0.03	63	0.85	-23
		200	0.51	-103	12.61	123	0.04	53	0.64	-35
		500	0.52	-161	6.24	93	0.06	50	0.38	-45
		1000	0.52	166	3.24	73	0.09	61	0.33	-54
		2000	0.59	125	1.66	47	0.17	67	0.29	-84
	15	100	0.48	-75	20.08	139	0.02	61	0.80	-27
		200	0.47	-121	13.89	117	0.04	53	0.57	-38
		500	0.53	-170	6.44	91	0.05	56	0.34	-44
		1000	0.53	162	3.33	72	0.09	66	0.31	-52
		2000	0.60	123	1.70	46	0.18	68	0.28	-82
	20	100	0.44	-88	21.62	136	0.02	60	0.76	-28
		200	0.47	-132	14.33	114	0.03	54	0.53	-38
		500	0.53	-175	6.45	89	0.05	60	0.32	-41
		1000	0.53	159	3.31	70	0.09	68	0.31	-50
		2000	0.61	122	1.69	45	0.18	70	0.28	-80
30	100	0.43	-112	21.45	130	0.02	58	0.72	-28	
	200	0.50	-148	13.38	109	0.03	57	0.51	-33	
	500	0.57	178	5.82	86	0.05	65	0.35	-34	
	1000	0.57	156	2.99	68	0.08	73	0.35	-46	
	2000	0.65	121	1.50	42	0.18	74	0.33	-78	

Table 4. MRF901 Common Emitter S-Parameters, VCE = 5.0 V

VCE (Volts)	IC (mA)	f (MHz)	S11		S21		S12		S22	
			S11	∠φ	S21	∠φ	S12	∠φ	S22	∠φ
10	5.0	100	0.73	-35	11.32	154	0.03	69	0.93	-14
		200	0.63	-69	9.69	135	0.05	57	0.79	-25
		500	0.53	-135	5.65	101	0.07	43	0.54	-38
		1000	0.51	-177	3.11	77	0.08	50	0.47	-48
		2000	0.57	132	1.58	48	0.14	66	0.41	-75
	10	100	0.59	-52	17.06	147	0.02	64	0.87	-19
		200	0.52	-95	13.06	125	0.04	54	0.69	-30
		500	0.49	-156	6.58	95	0.05	51	0.45	-37
		1000	0.50	170	3.44	74	0.08	62	0.41	-45
		2000	0.57	126	1.75	47	0.16	70	0.36	-72
	15	100	0.51	-66	20.36	141	0.02	63	0.83	-22
		200	0.47	-112	14.48	119	0.03	54	0.63	-31
		500	0.50	-166	6.81	92	0.05	57	0.41	-35
		1000	0.50	164	3.54	72	0.08	67	0.39	-43
		2000	0.58	124	1.78	46	0.16	72	0.35	-70
	20	100	0.47	-78	22.08	138	0.02	61	0.80	-23
		200	0.46	-123	15.07	116	0.03	55	0.60	-30
		500	0.50	-171	6.84	90	0.05	60	0.40	-32
		1000	0.51	162	3.51	71	0.08	69	0.39	-41
		2000	0.59	123	1.77	45	0.17	73	0.35	-68
30	100	0.44	-98	22.70	133	0.02	59	0.76	-23	
	200	0.47	-139	14.47	111	0.03	55	0.57	-27	
	500	0.53	-177	6.33	87	0.04	65	0.43	-28	
	1000	0.54	158	3.26	69	0.07	74	0.43	-39	
	2000	0.62	122	1.61	42	0.16	77	0.39	-68	

Table 5. MRF901 Common Emitter S-Parameters, VCE = 10 V

This datasheet has been downloaded from:

www.DatasheetCatalog.com

Datasheets for electronic components.