

MRF134



The RF MOSFET Line: Broadband RF Power FET
5.0W, to 400MHz, 28V

M/A-COM Products
Released - Rev. 05202009

Designed for wideband large-signal amplifier and oscillator applications up to 400 MHz range.

N-Channel enhancement mode

- Guaranteed 28V, 150 MHz performance
Output power = 5.0 watts
Minimum gain = 11 dB
Efficiency = 55% (Typical)
- Small- and large-signal characterization
- Typical performance at 400 MHz, 28V, 5.0W
Output = 10.6 dB gain
- 100% tested for load mismatch at all phase angles with 30:1 VSWR
- Low noise figure: 2.0 dB (Typ.) at 200 mA, 150 MHz
- Excellent thermal stability, ideally suited for Class A operation

Product Image

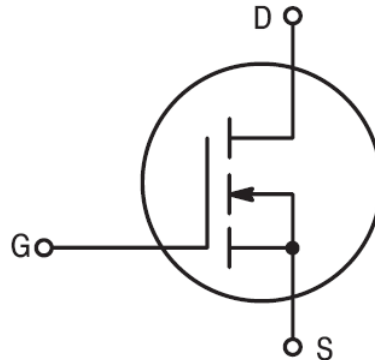

MAXIMUM RATINGS

Rating	Symbol	Value	Unit
Drain-Source Voltage	V_{DSS}	65	Vdc
Drain-Gate Voltage ($R_{GS} = 1.0 \text{ M}\Omega$)	V_{DGR}	65	Vdc
Gate-Source Voltage	V_{GS}	± 40	Vdc
Drain Current — Continuous	I_D	0.9	Adc
Total Device Dissipation @ $T_C = 25^\circ\text{C}$ Derate above 25°C	P_D	17.5 0.1	Watts W/ $^\circ\text{C}$
Storage Temperature Range	T_{stg}	-65 to +150	$^\circ\text{C}$

THERMAL CHARACTERISTICS

Rating	Symbol	Value	Unit
Thermal Resistance, Junction to Case	$R_{\theta JC}$	10	$^\circ\text{C/W}$

Handling and Packaging — MOS devices are susceptible to damage from electrostatic charge. Reasonable precautions in handling and packaging MOS devices should be observed.

The RF MOSFET Line: Broadband RF Power FET
5.0W, to 400MHz, 28V

M/A-COM Products
 Released - Rev. 05202009

ELECTRICAL CHARACTERISTICS ($T_C = 25^\circ\text{C}$ unless otherwise noted.)

Characteristic	Symbol	Min	Typ	Max	Unit
----------------	--------	-----	-----	-----	------

OFF CHARACTERISTICS

Drain-Source Breakdown Voltage ($V_{GS} = 0, I_D = 5.0 \text{ mA}$)	$V_{(BR)DSS}$	65	—	—	Vdc
Zero Gate Voltage Drain Current ($V_{DS} = 28 \text{ V}, V_{GS} = 0$)	I_{DSS}	—	—	1.0	mAdc
Gate-Source Leakage Current ($V_{GS} = 20 \text{ V}, V_{DS} = 0$)	I_{GSS}	—	—	1.0	μAdc

ON CHARACTERISTICS

Gate Threshold Voltage ($I_D = 10 \text{ mA}, V_{DS} = 10 \text{ V}$)	$V_{GS(th)}$	1.0	3.5	6.0	Vdc
Forward Transconductance ($V_{DS} = 10 \text{ V}, I_D = 100 \text{ mA}$)	g_{fs}	80	110	—	mmhos

DYNAMIC CHARACTERISTICS

Input Capacitance ($V_{DS} = 28 \text{ V}, V_{GS} = 0, f = 1.0 \text{ MHz}$)	C_{iss}	—	7.0	—	pF
Output Capacitance ($V_{DS} = 28 \text{ V}, V_{GS} = 0, f = 1.0 \text{ MHz}$)	C_{oss}	—	9.7	—	pF
Reverse Transfer Capacitance ($V_{DS} = 28 \text{ V}, V_{GS} = 0, f = 1.0 \text{ MHz}$)	C_{rss}	—	2.3	—	pF

FUNCTIONAL CHARACTERISTICS

Noise Figure ($V_{DS} = 28 \text{ Vdc}, I_D = 200 \text{ mA}, f = 150 \text{ MHz}$)	NF	—	2.0	—	dB
Common Source Power Gain ($V_{DD} = 28 \text{ Vdc}, P_{out} = 5.0 \text{ W}, I_{DQ} = 50 \text{ mA}$) $f = 150 \text{ MHz}$ (Fig. 1) $f = 400 \text{ MHz}$ (Fig. 14)	G_{ps}	11 —	14 10.6	— —	dB
Drain Efficiency (Fig. 1) ($V_{DD} = 28 \text{ Vdc}, P_{out} = 5.0 \text{ W}, f = 150 \text{ MHz}, I_{DQ} = 50 \text{ mA}$)	η	50	55	—	%
Electrical Ruggedness (Fig. 1) ($V_{DD} = 28 \text{ Vdc}, P_{out} = 5.0 \text{ W}, f = 150 \text{ MHz}, I_{DQ} = 50 \text{ mA},$ $\text{VSWR } 30:1$ at all Phase Angles)	ψ	No Degradation in Output Power			

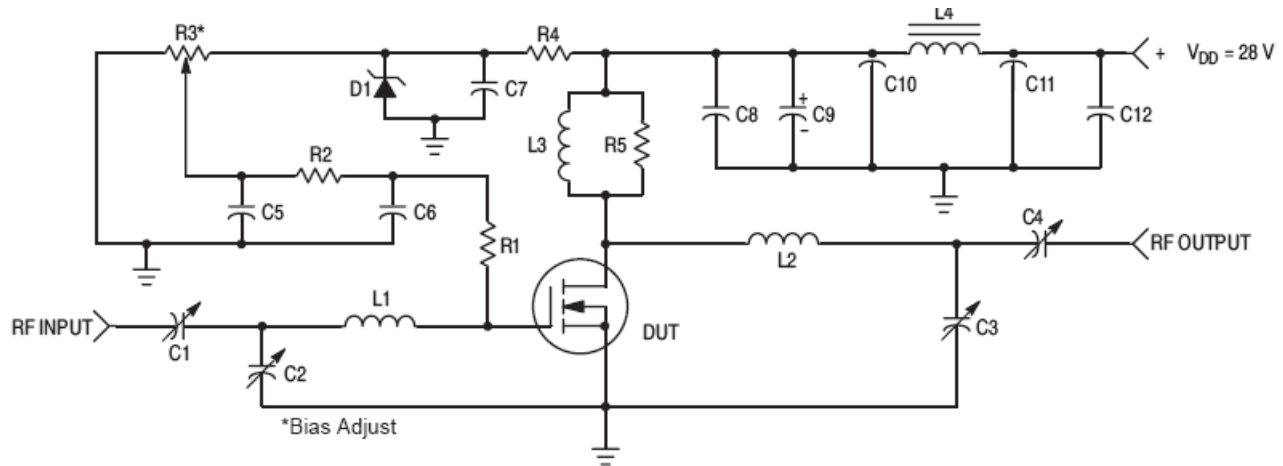

- | | |
|---|---|
| C1, C4 — Arco 406, 15–115 pF | L3 — 20 Turns, #20 AWG Enamel Wound on R5 |
| C2 — Arco 403, 3.0–35 pF | L4 — Ferroxcube VK-200 — 19/4B |
| C3 — Arco 402, 1.5–20 pF | R1 — 68 Ω, 1.0 W Thin Film |
| C5, C6, C7, C8, C12 — 0.1 μF Erie Redcap | R2 — 10 kΩ, 1/4 W |
| C9 — 10 μF, 50 V | R3 — 10 Turns, 10 kΩ Beckman Instruments 8108 |
| C10, C11 — 680 pF Feedthru | R4 — 1.8 kΩ, 1/2 W |
| D1 — 1N5925A Motorola Zener | R5 — 1.0 MΩ, 2.0 W Carbon |
| L1 — 3 Turns, 0.310" ID, #18 AWG Enamel, 0.2" Long | Board — G10, 62 mils |
| L2 — 3–1/2 Turns, 0.310" ID, #18 AWG Enamel, 0.25" Long | |

Figure 1. 150 MHz Test Circuit

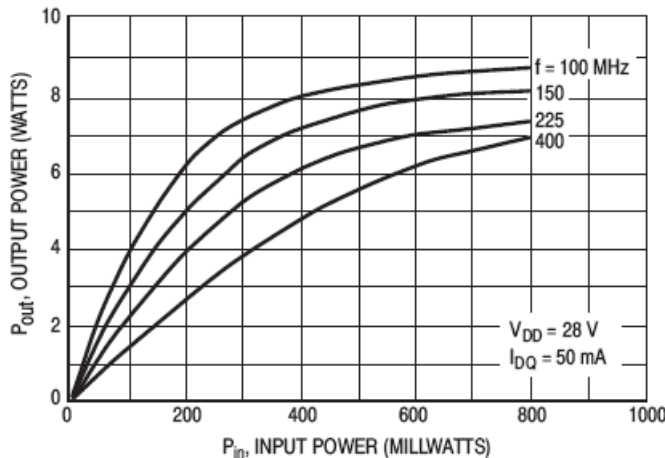

Figure 2. Output Power versus Input Power

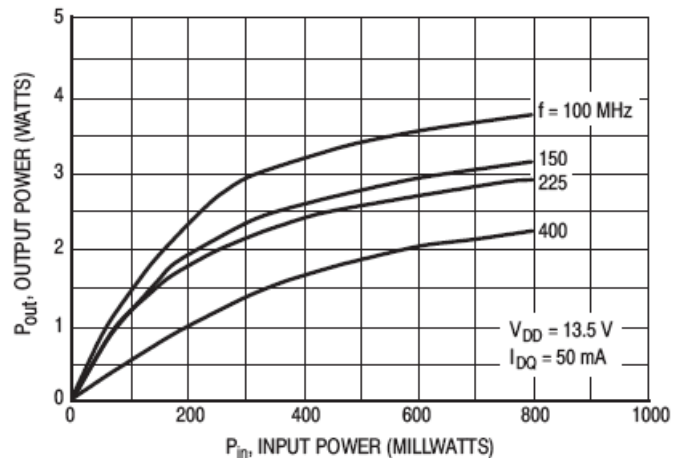

Figure 3. Output Power versus Input Power

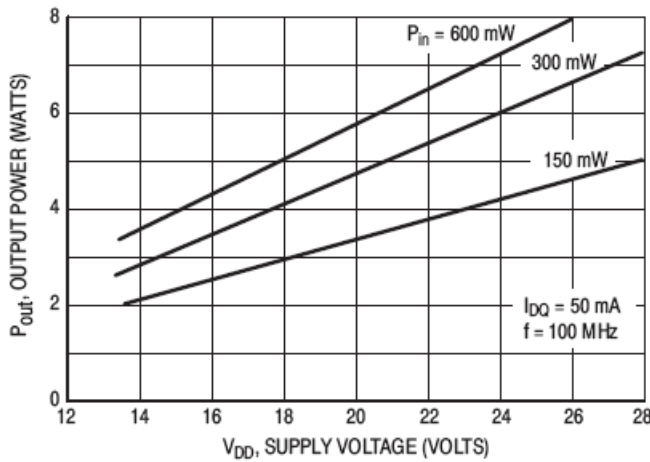

Figure 4. Output Power versus Supply Voltage

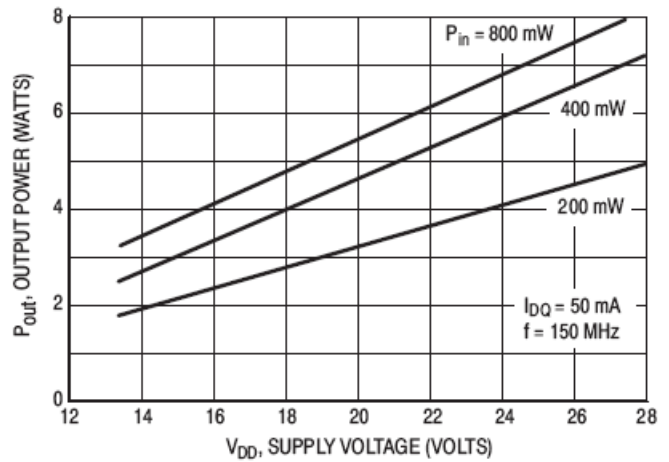

Figure 5. Output Power versus Supply Voltage

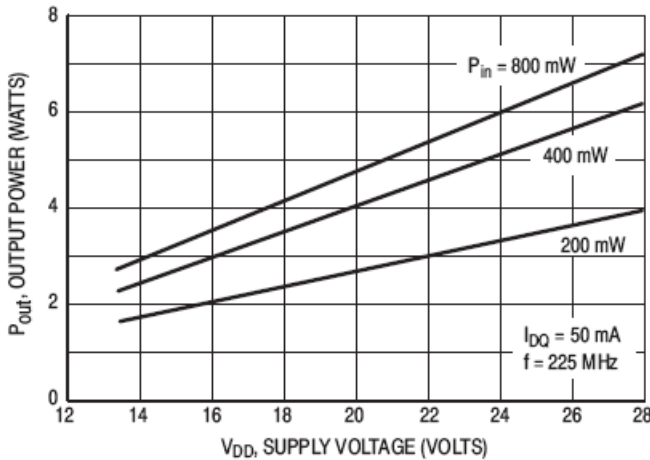

Figure 6. Output Power versus Supply Voltage

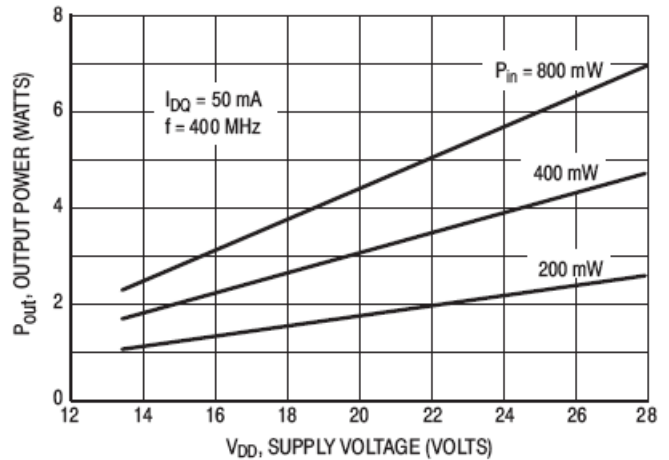

Figure 7. Output Power versus Supply Voltage

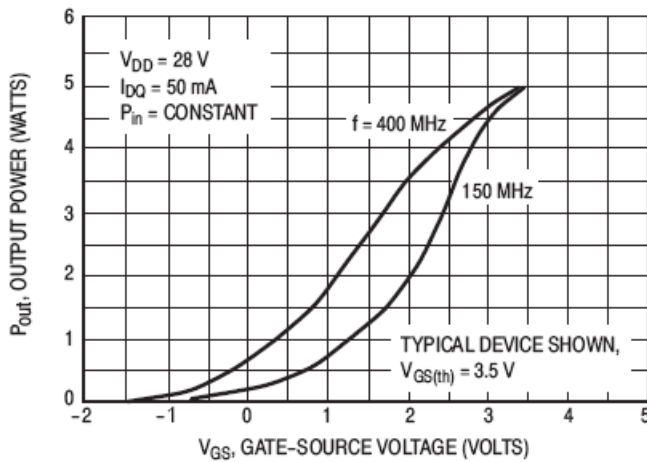

Figure 8. Output Power versus Gate Voltage

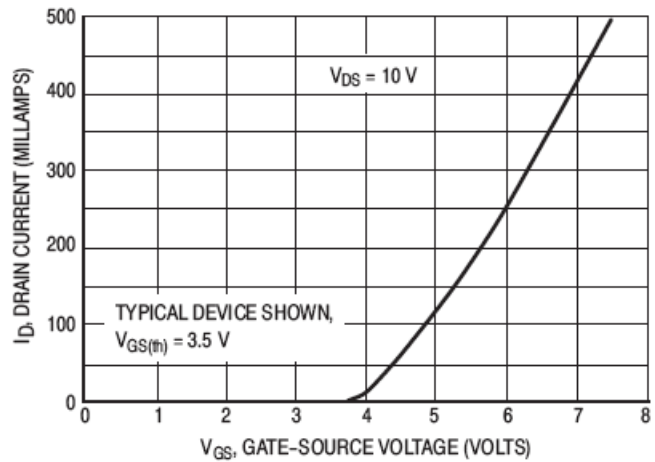

Figure 9. Drain Current versus Gate Voltage (Transfer Characteristics)

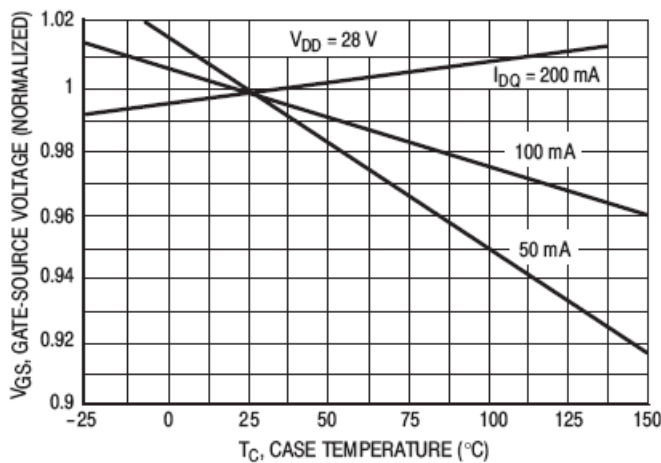

Figure 10. Gate-Source Voltage versus Case Temperature

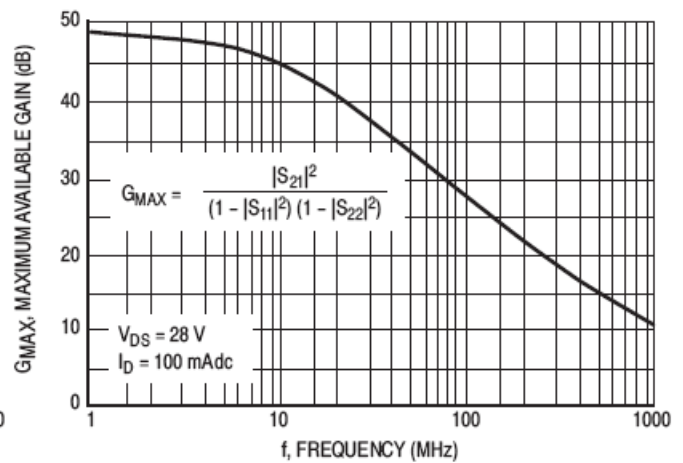

Figure 11. Maximum Available Gain versus Frequency

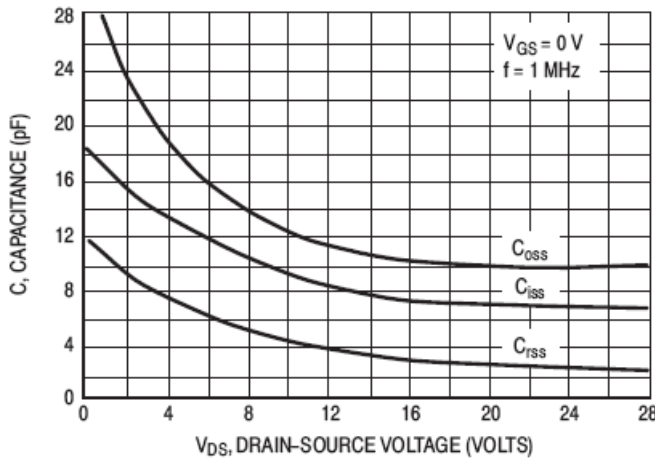

Figure 12. Capacitance versus Voltage

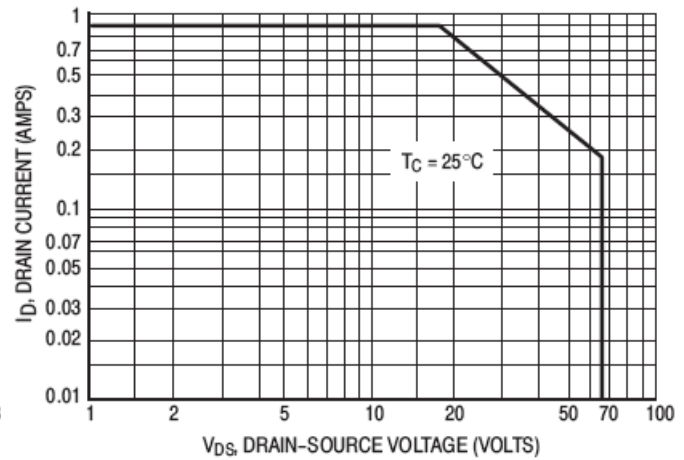
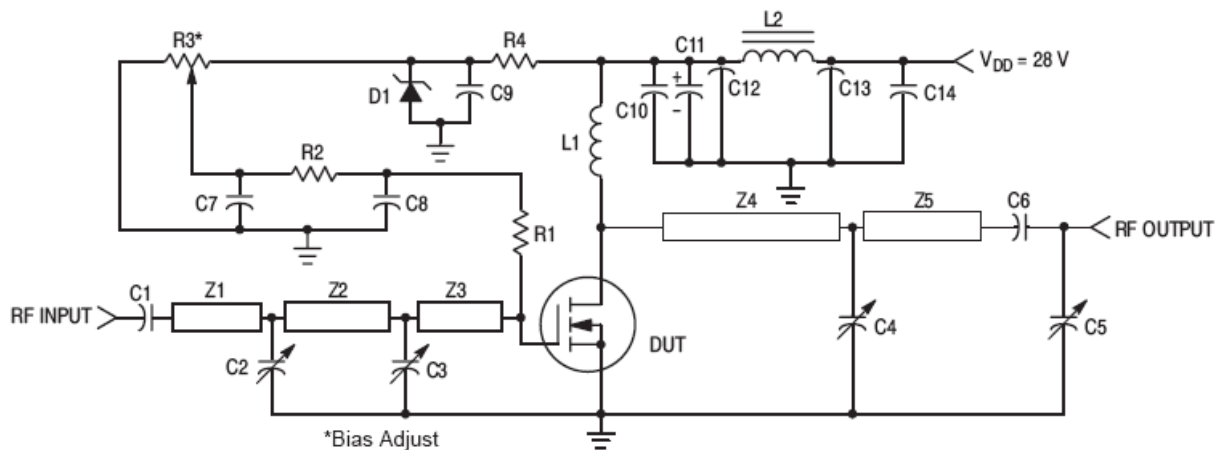

Figure 13. Maximum Rated Forward Biased Safe Operating Area



- | | |
|--|---|
| C1, C6 — 270 pF, ATC 100 mils | R2 — 10 k Ω , 1/4 W |
| C2, C3, C4, C5 — 0–20 pF Johanson | R3 — 10 Turns, 10 k Ω Beckman Instruments 8108 |
| C7, C9, C10, C14 — 0.1 μ F Erie Redcap, 50 V | R4 — 1.8 k Ω , 1/2 W |
| C8 — 0.001 μ F | Z1 — 1.4" x 0.166" Microstrip |
| C11 — 10 μ F, 50 V | Z2 — 1.1" x 0.166" Microstrip |
| C12, C13 — 680 pF Feedthru | Z3 — 0.95" x 0.166" Microstrip |
| D1 — 1N5925A Motorola Zener | Z4 — 2.2" x 0.166" Microstrip |
| L1 — 6 Turns, 1/4" ID, #20 AWG Enamel | Z5 — 0.85" x 0.166" Microstrip |
| L2 — Ferroxcube VK-200 — 19/4B | Board — Glass Teflon, 62 mils |
| R1 — 68 Ω , 1.0 W Thin Film | |

Figure 14. 400 MHz Test Circuit

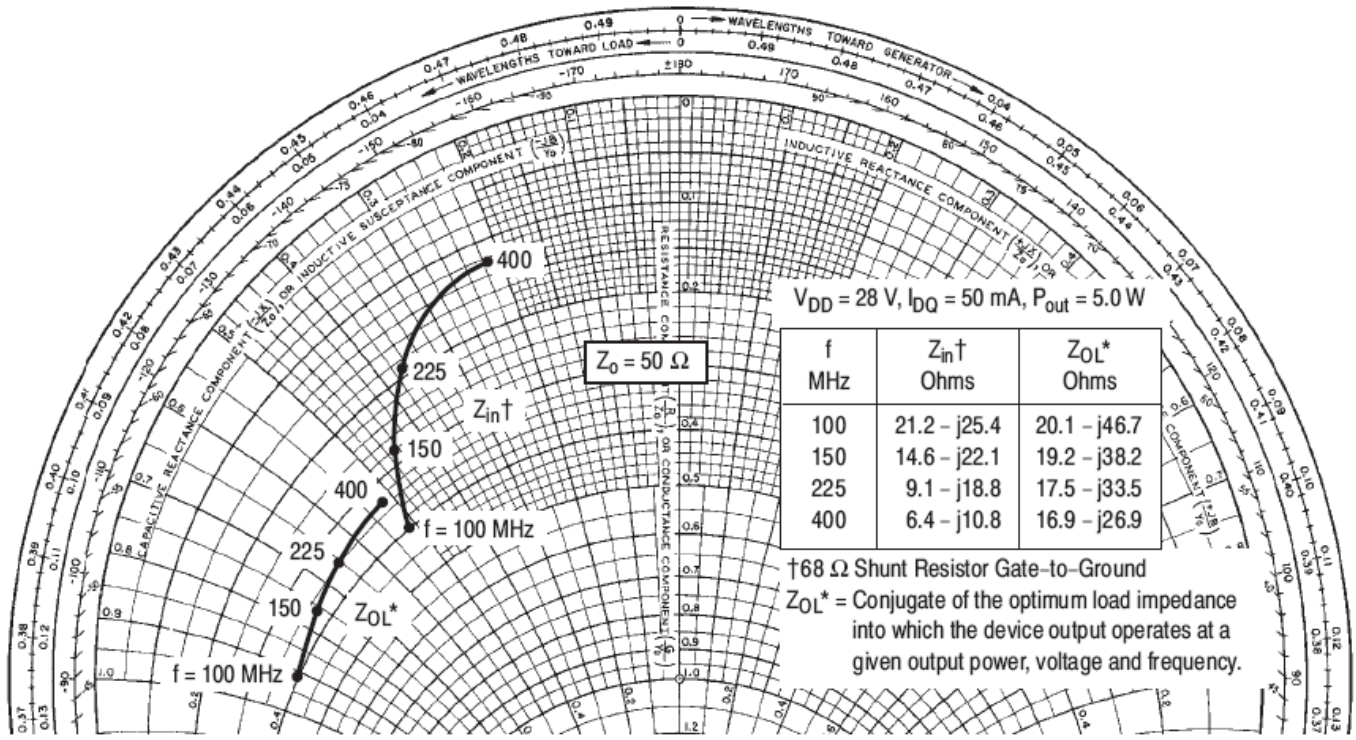

Figure 15. Large-Signal Series Equivalent Input/Output Impedances, Z_{in}^\dagger , Z_{OL}^*

f (MHz)	S ₁₁		S ₂₁		S ₁₂		S ₂₂	
	S ₁₁	∠φ	S ₂₁	∠φ	S ₁₂	∠φ	S ₂₂	∠φ
1.0	0.989	-1.0	11.27	179	0.0014	89	0.954	-1.0
2.0	0.989	-2.0	11.27	179	0.0028	89	0.954	-2.0
5.0	0.988	-5.0	11.26	176	0.0069	86	0.954	-4.0
10	0.985	-10	11.20	173	0.014	83	0.951	-9.0
20	0.977	-20	10.99	166	0.027	76	0.938	-18
30	0.965	-30	10.66	159	0.039	69	0.918	-26
40	0.950	-39	10.25	153	0.051	63	0.895	-34
50	0.931	-47	9.777	147	0.060	57	0.867	-42
60	0.912	-53	9.359	142	0.069	53	0.846	-49
70	0.892	-58	8.960	138	0.077	49	0.828	-56
80	0.874	-62	8.583	135	0.085	46	0.815	-62
90	0.855	-66	8.190	131	0.091	43	0.801	-68
100	0.833	-70	7.808	128	0.096	40	0.785	-74
110	0.827	-73	7.661	125	0.101	38	0.784	-77
120	0.821	-76	7.515	122	0.107	36	0.784	-82
130	0.814	-79	7.368	119	0.113	34	0.784	-85
140	0.808	-82	7.222	116	0.119	32	0.783	-88
150	0.802	-86	7.075	114	0.125	31	0.783	-90
160	0.788	-89	6.810	112	0.127	30	0.780	-92
170	0.774	-92	6.540	110	0.128	28	0.774	-94
180	0.763	-94	6.220	108	0.130	26	0.762	-98
190	0.751	-97	5.903	106	0.132	24	0.760	-100
200	0.740	-100	5.784	104	0.134	23	0.758	-103
225	0.719	-104	5.334	100	0.136	20	0.757	-107
250	0.704	-108	4.904	97	0.139	19	0.758	-110
275	0.687	-113	4.551	92	0.141	16	0.757	-114
300	0.673	-117	4.219	89	0.141	14	0.750	-117
325	0.668	-120	3.978	86	0.142	12	0.757	-120
350	0.669	-123	3.737	83	0.142	10	0.766	-121
375	0.662	-125	3.519	80	0.143	9.0	0.768	-123
400	0.654	-127	3.325	77	0.142	8.0	0.772	-124
425	0.650	-129	3.170	75	0.140	7.0	0.772	-125
450	0.638	-131	3.048	72	0.141	6.0	0.783	-125
475	0.614	-132	2.898	71	0.136	6.0	0.786	-126
500	0.641	-133	2.833	68	0.136	5.0	0.795	-127
525	0.638	-135	2.709	66	0.135	5.0	0.801	-127
550	0.633	-137	2.574	64	0.133	4.0	0.802	-128
575	0.628	-138	2.481	62	0.131	5.0	0.805	-128
600	0.625	-140	2.408	60	0.129	5.0	0.814	-128

The Power RF characterization data were measured with a 68 ohm resistor shunting the MRF134 input port. (continued)
The scattering parameters were measured on the MRF134 device alone with no external components.

Table 1. Common Source Scattering Parameters
V_{DS} = 28 V, I_D = 100 mA

f (MHz)	S ₁₁		S ₂₁		S ₁₂		S ₂₂	
	S ₁₁	∠φ	S ₂₁	∠φ	S ₁₂	∠φ	S ₂₂	∠φ
625	0.619	-142	2.334	58	0.128	5.0	0.818	-129
650	0.617	-144	2.259	56	0.125	6.0	0.824	-130
675	0.618	-146	2.192	55	0.123	7.0	0.834	-130
700	0.619	-147	2.124	53	0.122	8.0	0.851	-131
725	0.618	-150	2.061	51	0.120	9.0	0.859	-132
750	0.614	-152	1.983	49	0.118	11	0.857	-133
775	0.609	-154	1.908	48	0.119	13	0.865	-133
800	0.562	-155	1.877	49	0.118	15	0.872	-133
825	0.587	-156	1.869	46	0.119	16	0.869	-134
850	0.593	-158	1.794	44	0.118	18	0.875	-135
875	0.597	-160	1.749	43	0.119	18	0.881	-135
900	0.598	-162	1.700	41	0.118	18	0.889	-136
925	0.592	-164	1.641	40	0.115	18	0.888	-138
950	0.588	-166	1.590	39	0.112	20	0.877	-138
975	0.586	-168	1.572	39	0.108	23	0.864	-137
1000	0.590	-171	1.551	37	0.107	28	0.863	-137

The Power RF characterization data were measured with a 68 ohm resistor shunting the MRF134 input port. The scattering parameters were measured on the MRF134 device alone with no external components.

Table 1. Common Source Scattering Parameters (continued)
V_{DS} = 28 V, I_D = 100 mA

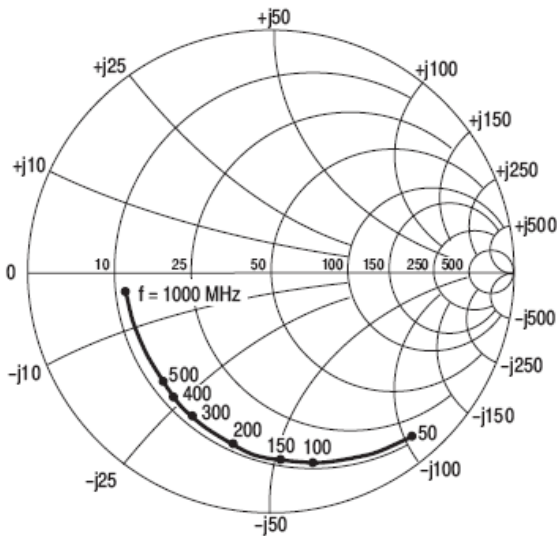

Figure 16. S_{11} , Input Reflection Coefficient versus Frequency
 $V_{DS} = 28\text{ V}$ $I_D = 100\text{ mA}$

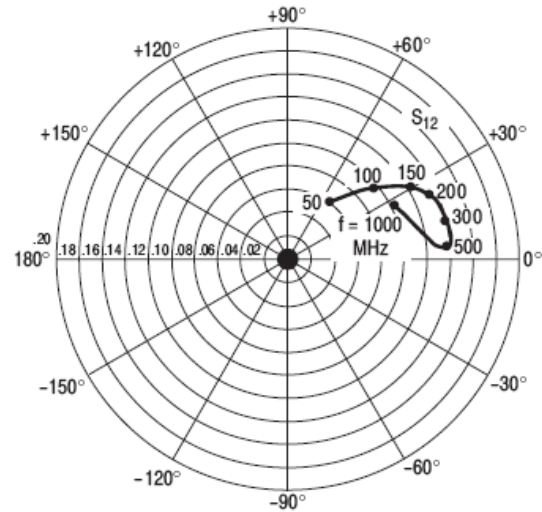

Figure 17. S_{12} , Reverse Transmission Coefficient versus Frequency
 $V_{DS} = 28\text{ V}$ $I_D = 100\text{ mA}$

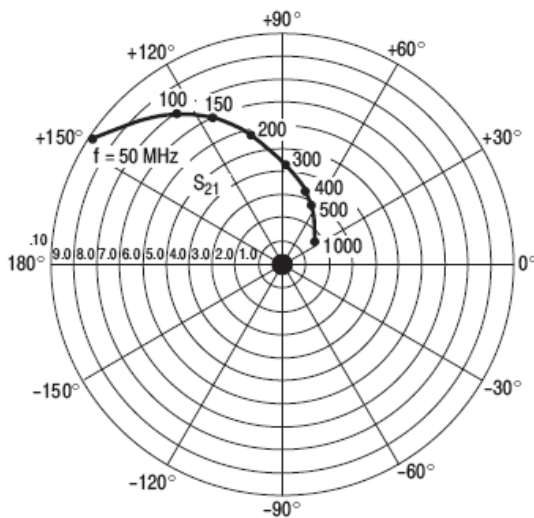

Figure 18. S_{21} , Forward Transmission Coefficient versus Frequency
 $V_{DS} = 28\text{ V}$ $I_D = 100\text{ mA}$

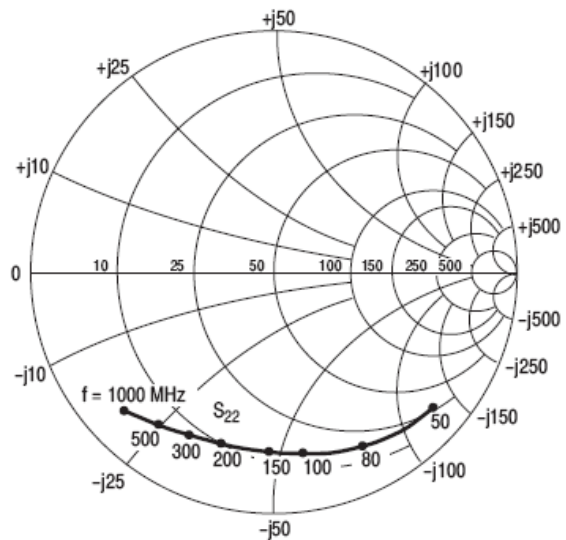

Figure 19. S_{22} , Output Reflection Coefficient versus Frequency
 $V_{DS} = 28\text{ V}$ $I_D = 100\text{ mA}$

RF POWER MOSFET CONSIDERATIONS

DESIGN CONSIDERATIONS

The MRF137 is a RF power N-Channel enhancement-mode field-effect transistor (FET) designed especially for VHF power amplifier applications. M/A-COM RF MOS FETs feature a vertical structure with a planar design, thus avoiding the processing difficulties associated with V-groove vertical power FETs.

M/A-COM Application Note AN211A, FETs in Theory and Practice, is suggested reading for those not familiar with the construction and characteristics of FETs.

The major advantages of RF power FETs include high gain, low noise, simple bias systems, relative immunity from thermal runaway, and the ability to withstand severely mismatched loads without suffering damage. Power output can be varied over a wide range with a low power dc control signal, thus facilitating manual gain control, ALC and modulation.

DC BIAS

The MRF137 is an enhancement mode FET and, therefore, does not conduct when drain voltage is applied. Drain current flows when a positive voltage is applied to the gate. See Figure 10 for a typical plot of drain current versus gate voltage. RF power FETs require forward bias for optimum performance.

The value of quiescent drain current (I_{DQ}) is not critical for many applications. The MRF137 was characterized at $I_{DQ} = 25$ mA, which is the suggested minimum value of I_{DQ} . For special applications such as linear amplification, I_{DQ} may have to be selected to optimize the critical parameters.

The gate is a dc open circuit and draws no current. Therefore, the gate bias circuit may generally be just a simple

resistive divider network. Some special applications may require a more elaborate bias system.

GAIN CONTROL

Power output of the MRF137 may be controlled from its rated value down to zero (negative gain) by varying the dc gate voltage. This feature facilitates the design of manual gain control, AGC/ALC and modulation systems. (See Figure 9.)

AMPLIFIER DESIGN

Impedance matching networks similar to those used with bipolar VHF transistors are suitable for MRF137. See M/A-COM Application Note AN721, Impedance Matching Networks Applied to RF Power Transistors. The higher input impedance of RF MOS FETs helps ease the task of broadband network design. Both small signal scattering parameters and large signal impedances are provided. While the s-parameters will not produce an exact design solution for high power operation, they do yield a good first approximation. This is an additional advantage of RF MOS power FETs.

RF power FETs are triode devices and, therefore, not unilateral. This, coupled with the very high gain of the MRF137, yields a device capable of self oscillation. Stability may be achieved by techniques such as drain loading, input shunt resistive loading, or output to input feedback. Two port parameter stability analysis with the MRF137 s-parameters provides a useful tool for selection of loading or feedback circuitry to assure stable operation. See M/A-COM Application Note AN215A for a discussion of two port network theory and stability.

MRF134



The RF MOSFET Line: Broadband RF Power FET
5.0W, to 400MHz, 28V

M/A-COM Products
Released - Rev. 05202009

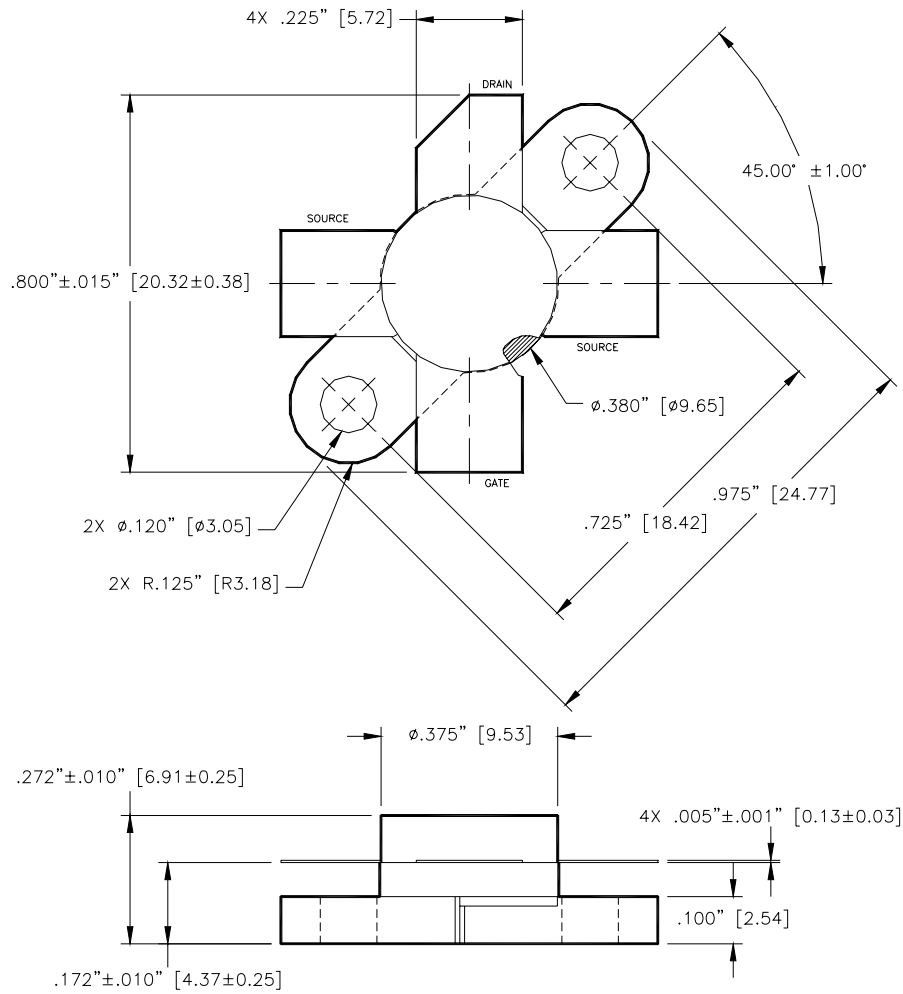

Unless otherwise noted, tolerances are inches $\pm .005''$ [millimeters $\pm 0.13\text{mm}$]