

Ferrite for Switching Power Supplies

E cores

EI/EE/EF/EER/ETD series

Issue date: February 2010

- All specifications are subject to change without notice.
 - Conformity to RoHS Directive: This means that, in conformity with EU Directive 2002/95/EC, lead, cadmium, mercury, hexavalent chromium, and specific bromine-based flame retardants, PBB and PBDE, have not been used, except for exempted applications.
-

Ferrite for Switching Power Supplies

E Series

- EI12.5 to EI60
- EE8 to EE60
- EF12.6 to EF32
- EER25.5 to EER49
- ETD19 to ETD49

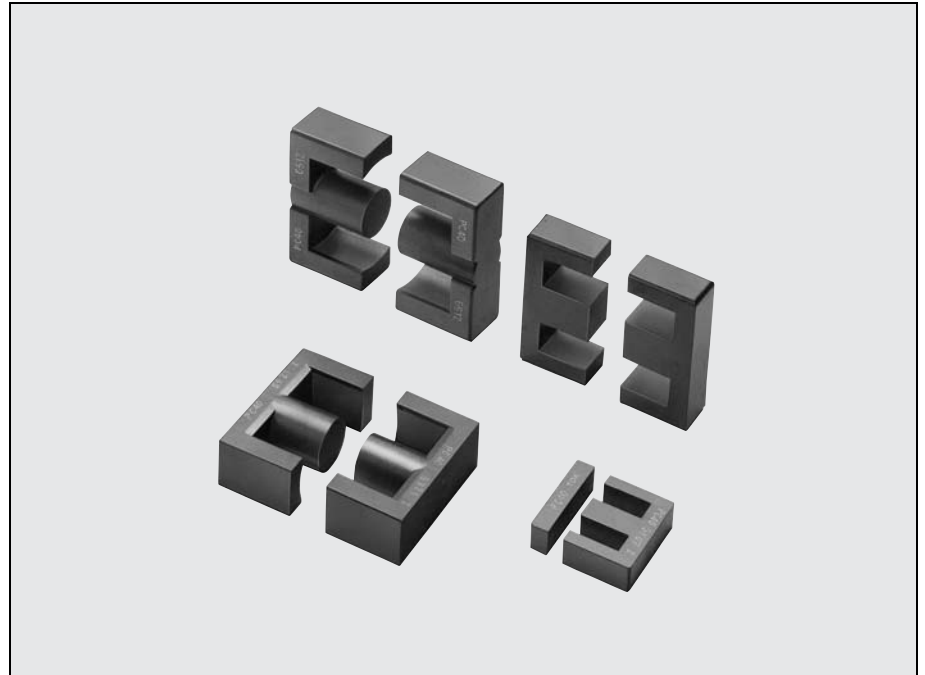

Ordering Code System

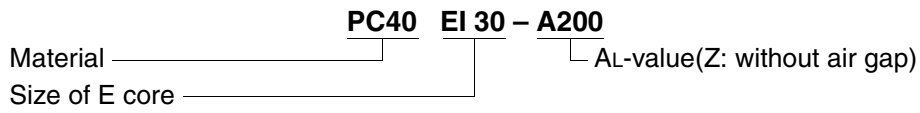

• All specifications are subject to change without notice.

EI CORES

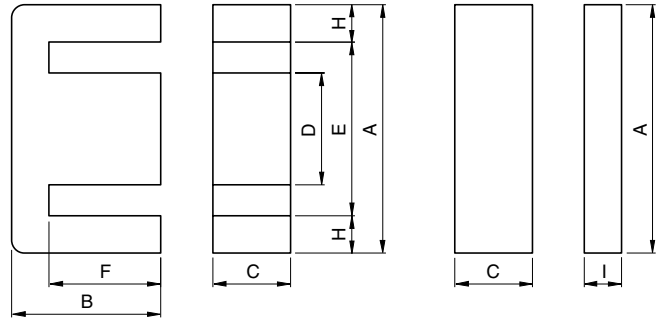
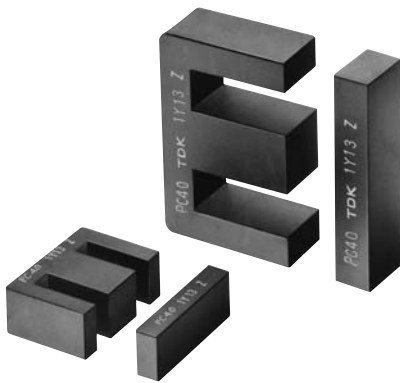

Part No.	JIS	Dimensions in mm							
		A	B	C	D	E min.	F	H	I
PC40EI12.5-Z	JIS FEI 12.5	12.4±0.3	7.4±0.1	4.85±0.15	2.4±0.1	8.8	5.1±0.1	1.6	1.5±0.1
PC40EI16-Z	JIS FEI 16	16.0±0.3	12.2±0.2	4.8±0.2	4.0±0.2	11.6	10.2±0.2	2.05	2.0±0.2
PC40EI19-Z		20.0±0.3	13.55±0.25	5.0±0.2	4.55±0.15	14.3	11.15±0.15	2.75	2.3±0.1
PC40EI22-Z		22.0±0.3	14.55±0.25	5.75±0.25	5.75±0.25	13.0	10.55±0.25	4.5	4.5±0.2
PC40EI22/19/6-Z	JIS FEI 22	22.0±0.4	14.7±0.2	5.75±0.25	5.75±0.25	15.75	10.7±0.2	3.0	4.0±0.2
PC40EI25-Z		25.3±0.5	15.55±0.25	6.75±0.25	6.5±0.3	19.0	12.35±0.25	3.0	2.7±0.2
PC40EI28-Z	JIS FEI 28	28.0 ^{+0.7} _{-0.5}	16.75±0.25	10.6±0.2(E core) 10.7±0.3(I core)	7.2±0.3	18.4	12.25±0.25	4.5	3.5±0.3
PC40EI30-Z	JIS FEI 30	30.0 ^{+0.7} _{-0.4}	21.25±0.25	10.7±0.3	10.7±0.3	19.7	16.25±0.25	5.0	5.5±0.2
PC40EI33/29/13-Z		33.0 ^{+0.8} _{-0.5}	23.75±0.25	12.7±0.3	9.7±0.3	23.4	19.25±0.25	4.45	5.0±0.3
PC40EI35-Z	JIS FEI 35	35.0±0.5	24.35±0.15	10.0±0.3	10.0±0.3	24.5	18.25±0.15	5.0	4.6±0.3

Part No.	Effective parameter				Electrical characteristics		Core loss (W) max. 100kHz, 200mT, 100°C	Weight (g)
	C ₁ (mm ⁻¹)	A _e (mm ²)	l _e (mm)	V _e (mm ³)	AL-value (nH/N ²)*			
					Without air gap	With air gap		
PC40EI12.5-Z	1.48	14.4	21.3	308	1200±25%	63±7% 100±10%	0.12	1.9
PC40EI16-Z	1.75	19.8	34.6	685	1100±25%	80±7% 160±10%	0.31	3.3
PC40EI19-Z	1.65	24.0	39.6	950	1400±25%	80±7% 160±10%	0.42	5.1
PC40EI22-Z	0.936	42.0	39.3	1650	2400±25%	125±7% 250±10%	0.6	9.8
PC40EI22/19/6-Z	1.13	37.0	41.8	1550	2000±25%	125±7% 250±10%	0.64	8.5
PC40EI25-Z	1.15	41.0	47.0	1930	2140±25%	125±7% 250±10%	0.79	9.8
PC40EI28-Z	0.56	86.0	48.2	4150	4300±25%	200±5% 400±7%	1.65	22
PC40EI30-Z	0.522	111	58.0	6440	4690±25%	200±5% 400±7%	3.1	34
PC40EI33/29/13-Z	0.567	119	67.5	8030	4400±25%	200±5% 400±7%	3.5	41
PC40EI35-Z	0.664	101	67.1	6780	3800±25%	200±5% 400±7%	2.85	36

* AL-value: 1kHz, 0.5mA, 100Ts

EI CORES

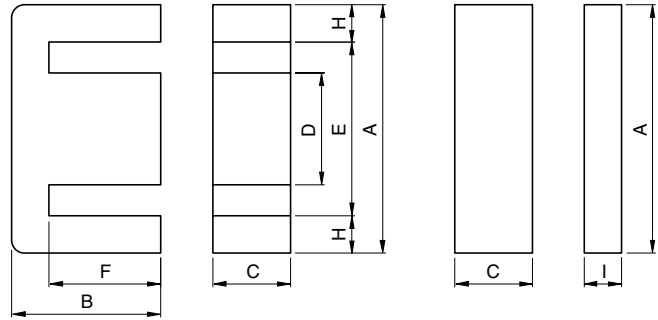
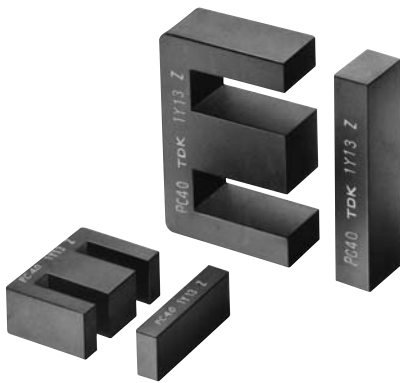

Part No.	JIS	Dimensions in mm							
		A	B	C	D	E min.	F	H	I
PC40EI40-Z	JIS FEI 40	40.0±0.5	27.25±0.25	11.65±0.35	11.65±0.35	27.2	20.25±0.25	6.2	7.5±0.3
PC40EI50-Z	JIS FEI 50	50.0 ^{+1.2} _{-0.7}	33.35±0.35	14.6±0.4	14.6±0.4	33.5	24.75±0.25	7.7	9.0±0.3
PC40EI60-Z	JIS FEI 60	60.0 ^{+1.4} _{-0.8}	35.85±0.35	15.6±0.4	15.6±0.4	43.6	27.85±0.35	7.7	8.5±0.3

Part No.	Effective parameter				Electrical characteristics			Weight (g)
	C ₁ (mm ⁻¹)	A _e (mm ²)	ℓ _e (mm)	V _e (mm ³)	AL-value (nH/N ²)*		Core loss (W) max. 100kHz, 200mT, 100°C	
					Without air gap	With air gap		
PC40EI40-Z	0.520	148	77.0	11400	4860±25%	200±5% 400±7%	4.8	60
PC40EI50-Z	0.409	230	94.0	21620	6110±25%	250±5% 500±7%	9.2	115
PC40EI60-Z	0.441	247	109	26900	5670±25%	250±5% 500±7%	12.5	139

* AL-value: 1kHz, 0.5mA, 100Ts

EE AND EF CORES

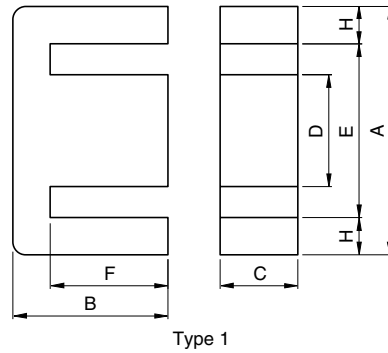
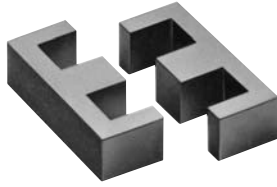
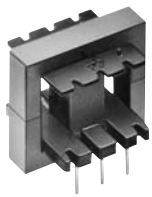

Type 1

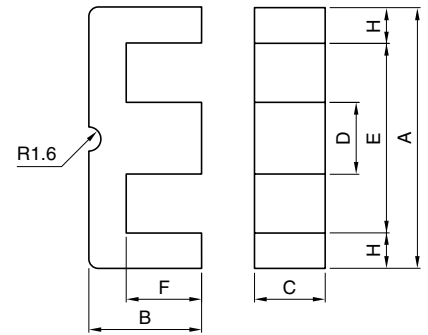

Type 2

Part No.	U.S. lam. cores, DIN standard JIS	Type	Dimensions in mm						
			A	B	C	D	E min.	F	H
PC40EE8-Z	JIS FEE 8.3	1	8.3±0.2	4.0±0.1	3.6±0.2	1.85±0.15	6.0	3.0±0.1	1.0
PC40EE10/11-Z	JIS FEE 10.2	1	10.2±0.2	5.5±0.1	4.75±0.15	2.45±0.15	7.7	4.20±0.15	1.1
PC40EF12.6-Z	DIN 41985	1	12.7±0.4	6.4±0.1	3.6±0.2	3.65±0.15	8.8	4.65±0.15	1.83
PC40EE13-Z		1	13.0±0.2	6.00±0.15	6.15±0.15	2.75±0.15	10.0	4.6±0.1	1.4
PC40EE16-Z	JIS FEE 16A	1	16.0±0.3	7.15±0.15	4.8±0.2	4.0±0.2	11.7	5.1±0.2	2.0
PC40SEE16-Z		1	16.0±0.3	7.15±0.15	6.8±0.2	3.18±0.18	12.5	5.5±0.1	1.6
PC40EF16-Z	DIN 41985	1	16.1±0.6	8.05±0.15	4.5±0.2	4.55±0.15	11.3	5.9±0.2	2.2
PC40EE19-Z	JIS FEE 19A	1	19.1±0.3	7.95±0.15	5.0±0.2	4.55±0.15	14.2	5.6±0.1	2.3
PC40EE19/16-Z	U.S. EE-187	1	19.29±0.32	8.1±0.18	4.75±0.13	4.75±0.08	14.05	5.715±0.125	2.46
PC40EE20/20/5-Z	DIN 41295	2	20.15±0.55	10.0±0.2	5.1±0.2	5.0±0.2	12.8	6.5±0.2	3.53

Part No.	Effective parameter				Electrical characteristics			Weight (g)
	C ₁ (mm ⁻¹)	A _e (mm ²)	ℓ _e (mm)	V _e (mm ³)	AL-value (nH/N ²)*		Core loss (W) max. 100kHz, 200mT, 100°C	
					Without air gap	With air gap		
PC40EE8-Z	2.75	7.0	19.2	134	610±25%	40±7% 63±10%	0.06	0.7
PC40EE10/11-Z	2.16	12.1	26.1	315	850±25%	40±7% 63±10%	0.14	1.5
PC40EF12.6-Z	2.28	13.0	29.6	385	810±25%	63±7% 100±10%	0.17	2.0
PC40EE13-Z	1.77	17.1	30.2	517	1130±25%	63±7% 100±10%	0.235	2.7
PC40EE16-Z	1.82	19.0	34.5	656	1140±25%	80±7% 160±10%	0.31	3.3
PC40SEE16-Z	1.69	21.7	36.6	795	1240±25%	80±7% 160±10%	0.37	4.1
PC40EF16-Z	1.87	20.1	37.6	754	1100±25%	63±7% 100±10%	0.32	3.9
PC40EE19-Z	1.71	23.0	39.4	906	1250±25%	80±7% 160±10%	0.42	4.8
PC40EE19/16-Z	1.75	22.4	39.1	876	1350±25%	80±7% 160±10%	0.41	4.8
PC40EE20/20/5-Z	1.38	31.0	43.0	1340	1400±25%	100±7% 160±10%	0.51	7.5

* AL-value: 1kHz, 0.5mA, 100Ts

EE AND EF CORES

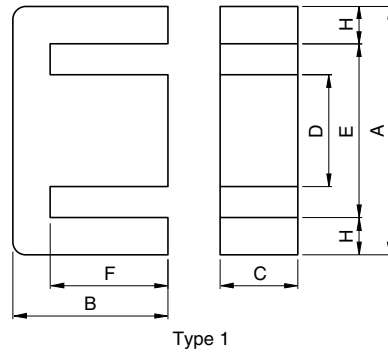
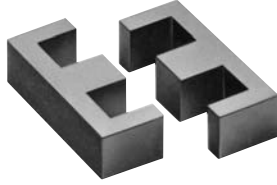
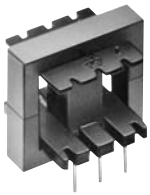

Type 1

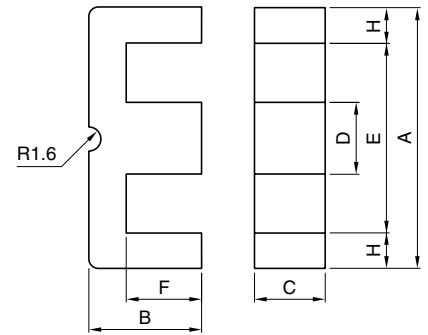

Type 2

Part No.	U.S. lam. cores, DIN standard JIS	Type	Dimensions in mm						
			A	B	C	D	E min.	F	H
PC40EF20-Z	DIN 41985	1	20.0±0.4	9.9±0.2	5.65±0.25	5.7±0.2	14.1	7.2±0.2	2.8
PC40EE22-Z		1	22.0±0.3	9.35±0.15	5.75±0.25	5.75±0.25	13.0	5.35±0.15	4.3
PC40EE25/19-Z	U.S. EE-24/25	1	25.4±0.5	9.46±0.19	6.29±0.19	6.35±0.25	18.55	6.41±0.19	3.11
PC40EF25-Z	DIN 41985	1	25.05±0.75	12.55±0.25	7.2±0.3	7.25±0.25	17.5	8.95±0.25	3.55
PC40EE25.4-Z	JIS FEE 25.4A	1	25.4±0.76	9.66±0.15	6.35±0.25	6.35±0.25	18.5	6.48±0.15	3.18
PC40EE30-Z	JIS FEE 30A	1	30.0±0.5	13.15±0.15	10.7±0.3	10.7±0.3	19.7	8.15±0.15	5.0
PC40EE30/30/7-Z	DIN 41295	2	30.1±0.7	15.0±0.2	7.05±0.25	6.95±0.25	19.5	9.95±0.25	5.1
PC40EF32-Z	DIN 41985	1	32.1±0.8	16.1±0.3	9.15±0.35	9.2±0.3	22.7	11.6±0.3	4.4
PC40EE35/28B-Z	U.S. EE-375	1	34.6±0.5	14.27±0.37	9.31±0.30	9.4±0.3	25.0	9.78±0.25	4.5
PC40EE35-Z	JIS FEE35B	1	34.54±1.0	14.35±0.35	9.53±0.38	9.39±0.27	24.89	9.71±0.28	4.75

Part No.	Effective parameter				Electrical characteristics			Weight (g)
	C ₁ (mm ⁻¹)	A _e (mm ²)	ℓ _e (mm)	V _e (mm ³)	AL-value (nH/N ²)*		Core loss (W) max. 100kHz, 200mT, 100°C	
					Without air gap	With air gap		
PC40EF20-Z	1.34	33.5	44.9	1500	1570±25%	100±7% 160±10%	0.69	7.4
PC40EE22-Z	0.970	41.0	39.6	1620	2180±25%	125±7% 250±10%	0.61	8.8
PC40EE25/19-Z	1.22	40.0	48.7	1950	2000±25%	100±7% 200±10%	0.86	9.1
PC40EF25-Z	1.11	51.8	57.8	2990	2000±25%	100±7% 160±10%	1.40	15
PC40EE25.4-Z	1.21	40.3	48.7	1963	2000±25%	125±7% 250±10%	0.90	10
PC40EE30-Z	0.529	109.0	57.7	6290	4690±25%	200±5% 400±7%	2.90	32
PC40EE30/30/7-Z	1.12	59.7	66.9	4000	2100±25%	160±5% 250±7%	1.51	22
PC40EF32-Z	0.893	83.2	74.3	6180	2590±25%	160±5% 250±7%	2.90	32
PC40EE35/28B-Z	0.819	84.9	69.6	5907	2950±25%	200±5% 400±7%	2.33	28
PC40EE35-Z	0.774	89.3	69.2	6179	3170±25%	200±5% 400±7%	3.00	57

* AL-value: 1kHz, 0.5mA, 100Ts

EE AND EF CORES

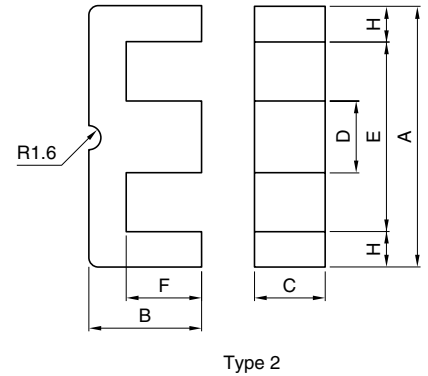
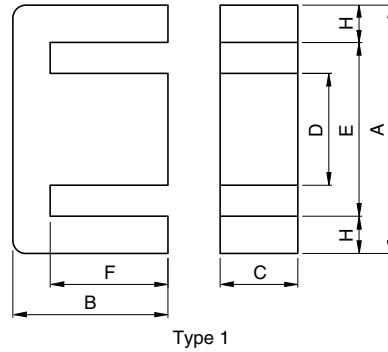
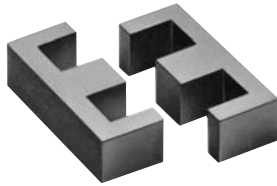

Part No.	U.S. lam. cores, DIN standard JIS		Type	Dimensions in mm						
				A	B	C	D	E min.	F	H
PC40EE40-Z	JIS FEE40A		1	40.0±0.5	17.0±0.3	10.7±0.3	10.7±0.3	27.4	10.25±0.25	6.0
PC40EE41/33C-Z	U.S. EE-21		1	41.07±0.8	16.78±0.4	12.57±0.38	12.64±0.45	28.55	10.38±0.3	6.0
PC40EE42/42/15-Z	DIN 41295	JIS FEE42A	1	42.15±0.85	21.0±0.2	14.95±0.25	11.95±0.25	29.5	15.15±0.35	6.025
PC40EE42/42/20-Z	DIN 41295	JIS FEE42B	1	42.15±0.85	21.0±0.2	19.7±0.3	11.95±0.25	29.5	15.15±0.35	6.025
PC40EE47/39-Z	U.S. EE-625		1	47.12±0.48	19.63±0.2	15.62±0.25	15.62±0.25	31.72	12.2±0.13	7.49
PC40EE50-Z	JIS FEE50A		1	50.0 ^{+1.0} _{-0.7}	21.3±0.3	14.6±0.4	14.6±0.4	34.2	12.75±0.25	7.5
PC40EE55/55/21-Z	DIN 41295	JIS FEE55	1	55.15±1.05	27.5±0.3	20.7±0.3	16.95±0.25	37.5	18.8±0.3	8.53
PC40EE57/47-Z	U.S. EE-75		1	56.57±1.0	23.60±0.23	18.8±0.25	18.80±0.25	38.1	14.63±0.15	9.02
PC40EE60-Z	JIS FEE60A		1	60.0 ^{+1.1} _{-0.8}	22.3±0.3	15.6±0.4	15.6±0.4	43.8	14.05±0.25	7.7

Part No.	Effective parameter				Electrical characteristics		Core loss (W) max. 100kHz, 200mT, 100°C	Weight (g)
	C ₁ (mm ⁻¹)	A _e (mm ²)	ℓ _e (mm)	V _e (mm ³)	AL-value (nH/N ²)*			
					Without air gap	With air gap		
PC40EE40-Z	0.606	128	77.3	9890	4150±25%	200±5% 400±7%	4.20	50
PC40EE41/33C-Z	0.495	157	77.6	12200	5060±25%	200±5% 400±7%	5.80	64
PC40EE42/42/15-Z	0.534	182	97.0	17600	4700±25%	250±5% 400±7%	8.00	80
PC40EE42/42/20-Z	0.415	235	97.4	22900	6100±25%	250±5% 400±7%	10.4	116
PC40EE47/39-Z	0.374	242	90.6	21930	6660±25%	250±5% 400±7%	9.70	108
PC40EE50-Z	0.425	226	95.8	21600	6110±25%	250±5% 500±7%	9.40	116
PC40EE55/55/21-Z	0.348	354	123	43700	7100±25%	250±5% 400±7%	11.0**	234
PC40EE57/47-Z	0.297	344	102	35100	8530±25%	250±5% 400±7%	8.5**	190
PC40EE60-Z	0.446	247	110	27100	5670±25%	250±5% 500±7%	12.5	135

* AL-value: 1kHz, 0.5mA, 100Ts

** Core loss: 100kHz, 150mT, 100°C

EER CORES

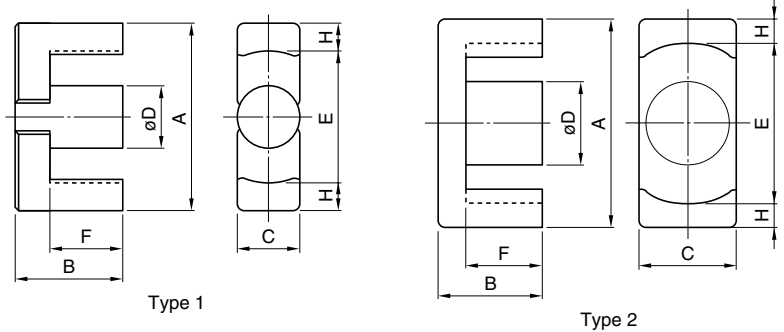
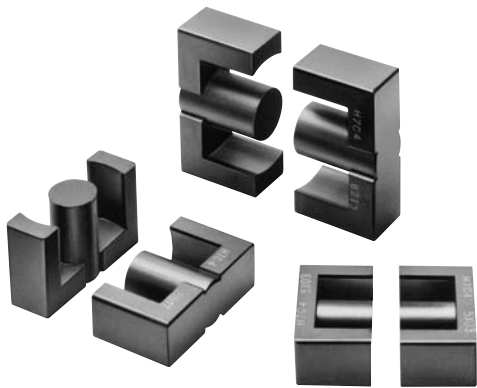

Part No.	U.S. lam. cores, DIN standard JIS	Type	Dimensions in mm						
			A	B	C	øD	E min.	F	H
PC40EER25.5-Z PC95EER25.5-Z	JIS FEER25.5A	1	25.5±0.5	9.3±0.2	7.5±0.2	7.5±0.15	19.8	6.2±0.2	2.6
PC40EER28-Z PC95EER28-Z	JIS FEER28.5A	2	28.55±0.55	14.0±0.2	11.4±0.25	9.9±0.25	21.2	9.65±0.25	3.4
PC40EER28L-Z PC95EER28L-Z	JIS FEER28.5B	2	28.55±0.55	16.9±0.25	11.4±0.25	9.9±0.25	21.2	12.53±0.28	3.4
PC40EER35-Z PC95EER35-Z	JIS FEER35A	1	35.0±0.5	20.7±0.2	11.3±0.2	11.3±0.15	25.6	14.7±0.3	4.43
PC40EER40-Z PC95EER40-Z		1	40.0±0.5	22.4±0.2	13.3±0.25	13.3±0.25	29.0	15.4±0.3	5.28
PC40EER42-Z	JIS FEER42	1	42.0±0.6	22.4±0.2	15.5±0.25	15.5±0.25	29.4	15.4±0.3	6.0
PC40EER42/42/20-Z		2	42.15±0.65	21.2±0.2	19.60±0.4	17.3±0.25	31.8	15.25±0.25	4.93
PC40EER49-Z		1	49.0±0.8	19.0±0.3	17.2±0.4	17.2±0.25	36.4	12.4±0.2	6.0

Part No.	Effective parameter				Electrical characteristics			Weight (g)
	C ₁ (mm ⁻¹)	A _e (mm ²)	l _e (mm)	V _e (mm ³)	AL-value (nH/N ²)*		Core loss (W) max. 100kHz, 200mT, 100°C	
					Without air gap	With air gap		
PC40EER25.5-Z PC95EER25.5-Z	1.08	44.8	48.2	2160	1920±25% 2700±25%	100±5% 200±7%	0.98 1.1/0.9/1.1***	11
PC40EER28-Z PC95EER28-Z	0.780	82.1	64.0	5250	2870±25% 4000±25%	200±5% 400±7%	2.30 2.45/2.1/2.45***	28
PC40EER28L-Z PC95EER28L-Z	0.928	81.4	75.5	6150	2520±25% 3500±25%	160±5% 315±7%	2.70 2.9/2.45/2.9***	33
PC40EER35-Z PC95EER35-Z	0.849	107	90.8	9720	2770±25% 4000±25%	200±5% 400±7%	4.20 4.55/3.8/4.55***	52
PC40EER40-Z PC95EER40-Z	0.658	149	98.0	14600	3620±25% 5200±25%	200±5% 400±7%	6.30 6.8/5.7/6.8***	78
PC40EER42-Z	0.509	194	98.8	19200	4690±25%	250±5% 500±7%	8.60	102
PC40EER42/42/20-Z	0.411	240	98.6	23700	5340±25%	250±5% 500±7%	10.7	116
PC40EER49-Z	0.395	231	91.3	21100	6250±25%	250±5% 500±7%	5.4**	110

* AL-value: 1kHz, 0.5mA, 100Ts

** Core loss: 100kHz, 150mT, 100°C

*** Core loss: 100kHz, 200mT, 25°C/80°C/120°C

ETD CORES

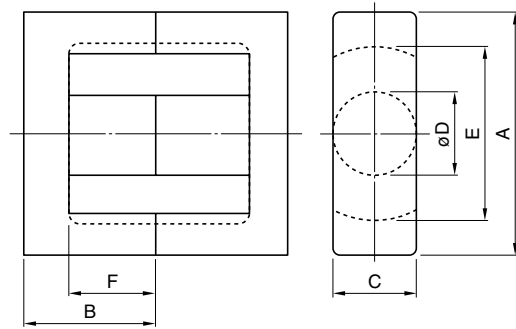
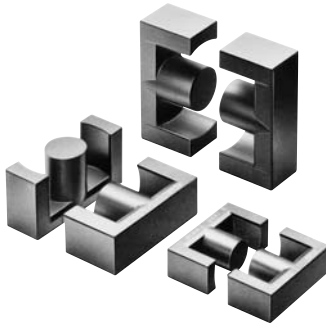

Part No.	JIS	Dimensions in mm					
		A	B	C	øD	E	F
PC40ETD19-Z		19.6±0.5	13.65±0.15	7.4±0.2	7.4±0.2	14.9±0.5	9.4±0.2
PC40ETD24-Z		24.4±0.6	14.45±0.15	8.5±0.4	8.5±0.2	18.6±0.6	10.1±0.2
PC40ETD29-Z		29.8±0.8	15.80±0.15	9.5±0.3	9.5±0.3	22.7±0.7	11.0±0.3
PC40ETD34-Z	JIS FEER 34.2	34.2±0.8	17.3±0.2	10.88±0.38	10.8±0.3	26.3±0.7	12.1±0.3
PC40ETD39-Z	JIS FEER 39.1	39.1±0.9	19.8±0.2	12.58±0.38	12.5±0.3	30.1±0.8	14.6±0.4
PC40ETD44-Z	JIS FEER 44	44.0±1.0	22.3±0.2	14.9±0.5	14.8±0.4	33.3±0.8	16.5±0.4
PC40ETD49-Z	JIS FEER 48.7	48.7±1.1	24.7±0.2	16.4±0.5	16.3±0.4	37.0±0.9	18.1±0.4

Part No.	Effective parameter				Electrical characteristics			Weight (g)
	C ₁ (mm ⁻¹)	A _e (mm ²)	ℓ _e (mm)	V _e (mm ³)	AL-value (nH/N ²)*		Core loss (W) max. 100kHz, 200mT, 100°C	
					Without air gap	With air gap		
PC40ETD19-Z	1.32	41.3	54.6	2260	1720±25%	80±5% 160±7%	1.1	14
PC40ETD24-Z	1.100	56.3	61.9	3480	2125±25%	100±5% 200±7%	1.6	20
PC40ETD29-Z	0.959	73.6	70.6	5200	2500±25%	200±5% 400±10%	2.4	28
PC40ETD34-Z	0.810	97.1	78.6	7630	2780±25%	200±5% 400±7%	3.31	40
PC40ETD39-Z	0.737	125	92.1	11500	3150±25%	200±5% 400±7%	5.3	60
PC40ETD44-Z	0.589	175	103	18000	4000±25%	250±5% 400±7%	8.3	94
PC40ETD49-Z	0.535	213	114	24300	4440±25%	250±5% 400±7%	11.2	124

* AL-value: 1kHz, 0.5mA, 100Ts

EI Series EI12.5 Cores(JIS FEI 12.5)

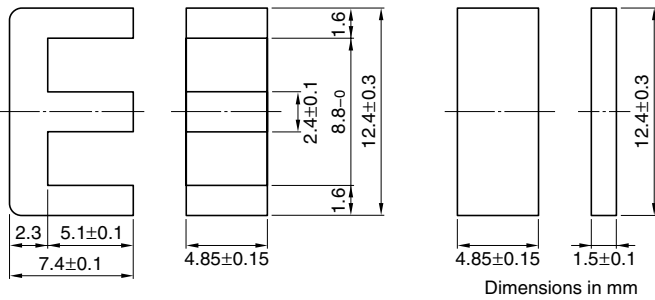

PARAMETER

Core factor	C1	mm ⁻¹	1.48
Effective magnetic path length	ℓ _e	mm	21.3
Effective cross-sectional area	A _e	mm ²	14.4
Effective core volume	V _e	mm ³	308
Cross-sectional center pole area	A _{cp}	mm ²	11.6
Minimum cross-sectional area	A _{cp min.}	mm ²	10.8
Cross-sectional winding area of core	A _{cw}	mm ²	17.3
Weight (approx.)		g	1.9

Part No.	AL-value (nH/N ²)	Core loss (W) at 100°C 100kHz, 200mT	Calculated output power (forward converter mode)
PC40EI12.5-Z	1200±25% (1kHz, 0.5mA)* 2120 min. (100kHz, 200mT)	0.12 max.	8.8W (100kHz)

* Coil: ø0.2 2UEW 100Ts

NI limit vs. AL-value for PC40EI12.5 gapped core (Typical)

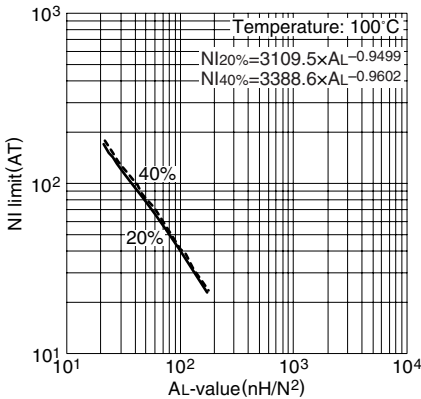

Note: NI limit shows the point where the exciting current is 20% and 40% away from its extended linear part.

AL-value vs. Air gap length for PC40EI12.5 core (Typical)

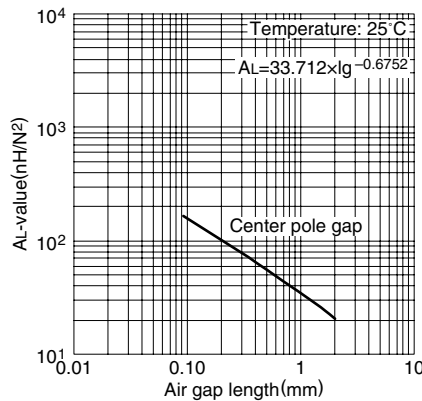

Measuring conditions • Coil: ø0.2 2UEW 100Ts
• Frequency: 1kHz
• Level: 0.5mA

Temperature rise vs. Total loss for EI12.5 core (Typical) (Ambient temperature: 25°C)

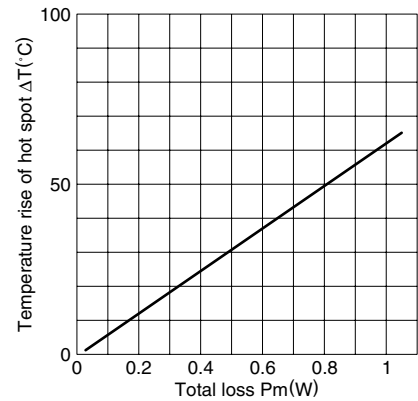

Note: The temperature rise is measured in the room whose temperature and humidity are fixed to 25°C and 45(%)RH, respectively. (approx. 400×300×300cm)

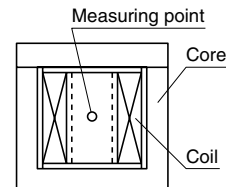

EI Series EI16 Cores(JIS FEI 16)

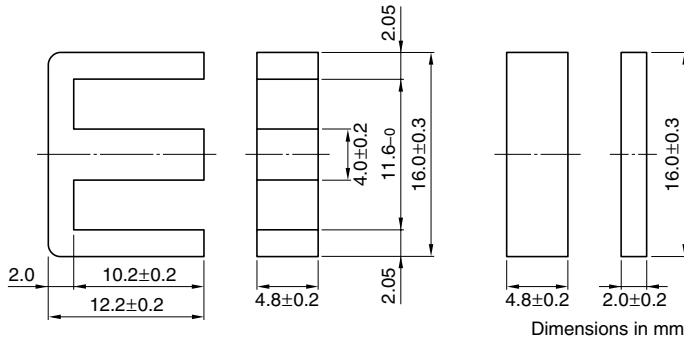

PARAMETER

Core factor	C1	mm ⁻¹	1.75
Effective magnetic path length	ℓ _e	mm	34.6
Effective cross-sectional area	A _e	mm ²	19.8
Effective core volume	V _e	mm ³	685
Cross-sectional center pole area	A _{cp}	mm ²	19.2
Minimum cross-sectional area	A _{cp min.}	mm ²	17.5
Cross-sectional winding area of core	A _{cw}	mm ²	40.3
Weight (approx.)		g	3.3

Part No.	AL-value (nH/N ²)	Core loss (W) at 100°C 100kHz, 200mT	Calculated output power (forward converter mode)
PC40EI16-Z	1100±25% (1kHz, 0.5mA)* 1750 min. (100kHz, 200mT)	0.31 max.	29W (100kHz)

* Coil: ø0.23 2UEW 100Ts

NI limit vs. AL-value for PC40EI16 gapped core (Typical)

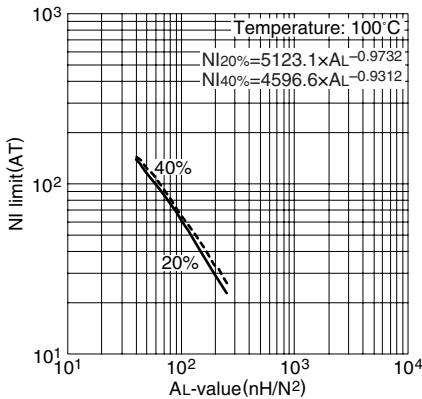

Note: NI limit shows the point where the exciting current is 20% and 40% away from its extended linear part.

AL-value vs. Air gap length for PC40EI16 core (Typical)

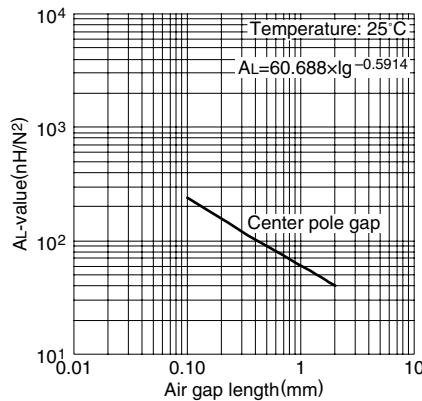

Measuring conditions

- Coil: ø0.23 2UEW 100Ts
- Frequency: 1kHz
- Level: 0.5mA

Temperature rise vs. Total loss for EI16 core (Typical) (Ambient temperature: 25°C)

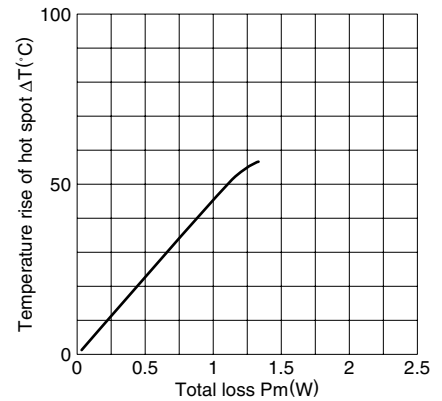

Note: The temperature rise is measured in the room whose temperature and humidity are fixed to 25°C and 45(%RH), respectively. (approx. 400×300×300cm)

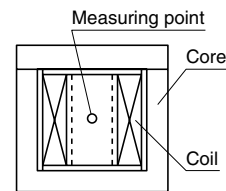

EI Series EI19 Cores

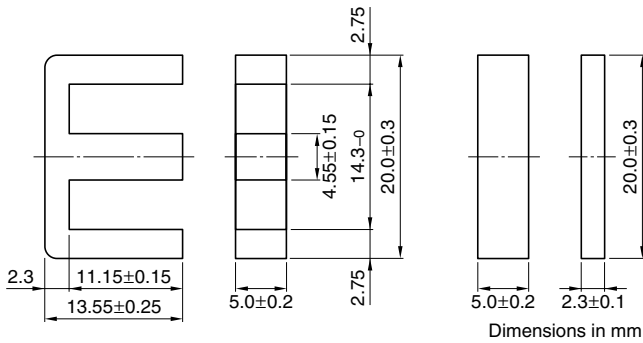

PARAMETER

Core factor	C1	mm ⁻¹	1.65
Effective magnetic path length	ℓ _e	mm	39.6
Effective cross-sectional area	A _e	mm ²	24.0
Effective core volume	V _e	mm ³	950
Cross-sectional center pole area	A _{cp}	mm ²	22.8
Minimum cross-sectional area	A _{cp min.}	mm ²	21.1
Cross-sectional winding area of core	A _{cw}	mm ²	55.5
Weight (approx.)		g	5.1

Part No.	AL-value (nH/N ²)	Core loss (W) at 100°C 100kHz, 200mT	Calculated output power (forward converter mode)
PC40EI19-Z	1400±25% (1kHz, 0.5mA)* 1830 min. (100kHz, 200mT)	0.42 max.	40W (100kHz)

* Coil: ø0.23 2UEW 100Ts

NI limit vs. AL-value for PC40EI19 gapped core (Typical)

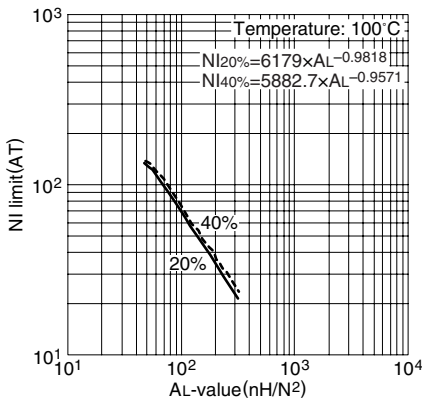

Note: NI limit shows the point where the exciting current is 20% and 40% away from its extended linear part.

AL-value vs. Air gap length for PC40EI19 core (Typical)

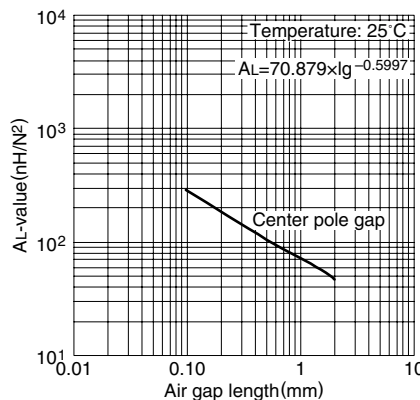

Measuring conditions • Coil: ø0.23 2UEW 100Ts
• Frequency: 1kHz
• Level: 0.5mA

Temperature rise vs. Total loss for EI19 core (Typical)
(Ambient temperature: 25°C)

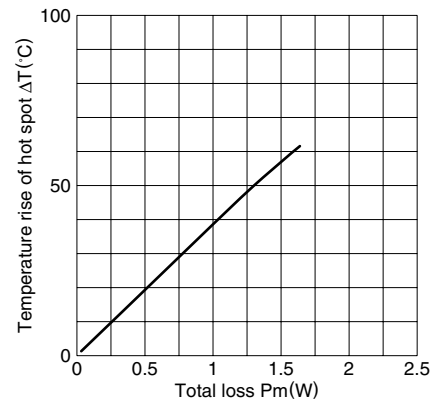

Note: The temperature rise is measured in the room whose temperature and humidity are fixed to 25°C and 45%RH, respectively. (approx. 400×300×300cm)

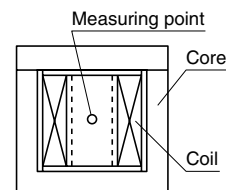

EI Series EI22 Cores

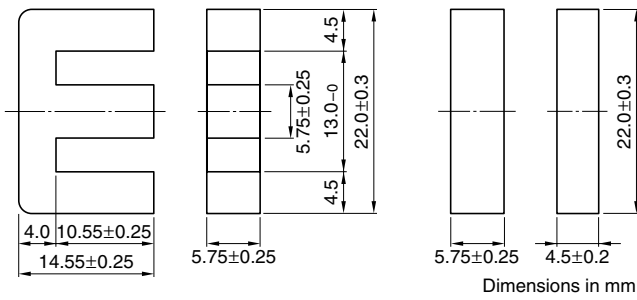

PARAMETER

Core factor	C1	mm ⁻¹	0.936
Effective magnetic path length	ℓ _e	mm	39.3
Effective cross-sectional area	A _e	mm ²	42.0
Effective core volume	V _e	mm ³	1650
Cross-sectional center pole area	A _{cp}	mm ²	33.1
Minimum cross-sectional area	A _{cp min.}	mm ²	30.3
Cross-sectional winding area of core	A _{cw}	mm ²	38.2
Weight (approx.)		g	9.8

Part No.	AL-value (nH/N ²)	Core loss (W) at 100°C 100kHz, 200mT	Calculated output power (forward converter mode)
PC40EI22-Z	2400±25% (1kHz, 0.5mA)* 3360 min. (100kHz, 200mT)	0.60 max.	33W (100kHz)

* Coil: ø0.23 2UEW 100Ts

NI limit vs. AL-value for PC40EI22 gapped core (Typical)

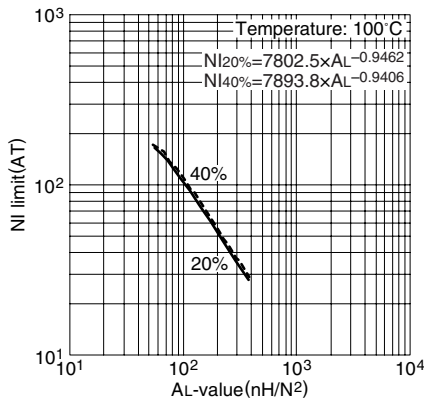

Note: NI limit shows the point where the exciting current is 20% and 40% away from its extended linear part.

AL-value vs. Air gap length for PC40EI22 core (Typical)

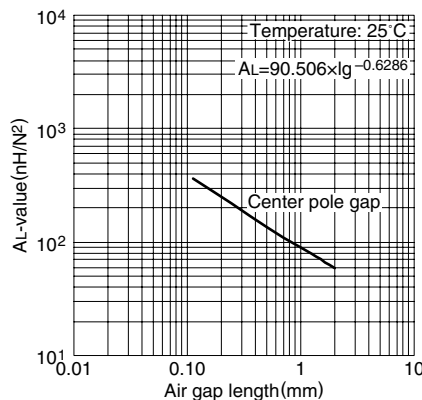

Measuring conditions • Coil: ø0.23 2UEW 100Ts
• Frequency: 1kHz
• Level: 0.5mA

Temperature rise vs. Total loss for EI22 core (Typical) (Ambient temperature: 25°C)

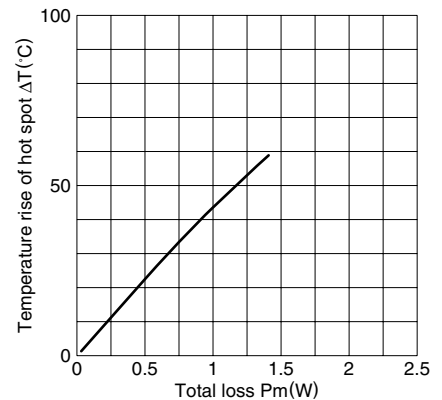

Note: The temperature rise is measured in the room whose temperature and humidity are fixed to 25°C and 45%RH, respectively. (approx. 400×300×300cm)

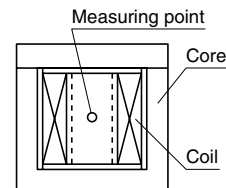

EI Series EI22/19/6 Cores(JIS FEI 22)

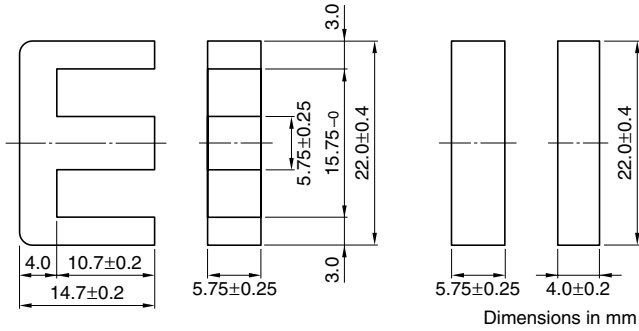

PARAMETER

Core factor	C1	mm ⁻¹	1.13
Effective magnetic path length	ℓ _e	mm	41.8
Effective cross-sectional area	A _e	mm ²	37.0
Effective core volume	V _e	mm ³	1550
Cross-sectional center pole area	A _{cp}	mm ²	33.1
Minimum cross-sectional area	A _{cp min.}	mm ²	30.3
Cross-sectional winding area of core	A _{cw}	mm ²	54.8
Weight (approx.)		g	8.5

Part No.	AL-value (nH/N ²)	Core loss (W) at 100°C 100kHz, 200mT	Calculated output power (forward converter mode)
PC40EI22/19/6-Z	2000±25% (1kHz, 0.5mA)* 2780 min. (100kHz, 200mT)	0.64 max.	48W (100kHz)

* Coil: ø0.23 2UEW 100Ts

NI limit vs. AL-value for PC40EI22/19/6 gapped core (Typical)

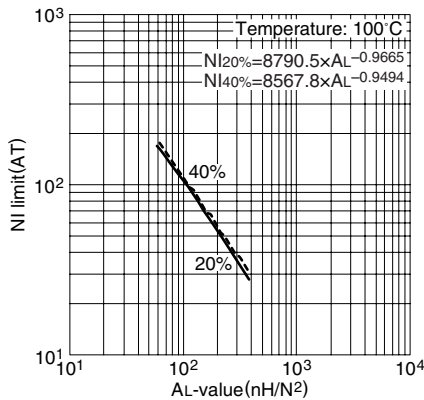

Note: NI limit shows the point where the exciting current is 20% and 40% away from its extended linear part.

AL-value vs. Air gap length for PC40EI22/19/6 core (Typical)

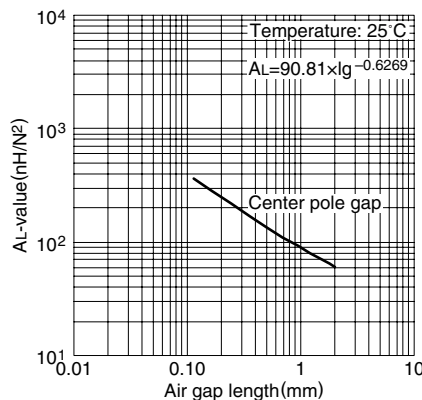

Measuring conditions • Coil: ø0.23 2UEW 100Ts
• Frequency: 1kHz
• Level: 0.5mA

Temperature rise vs. Total loss for EI22/19/6 core (Typical) (Ambient temperature: 25°C)

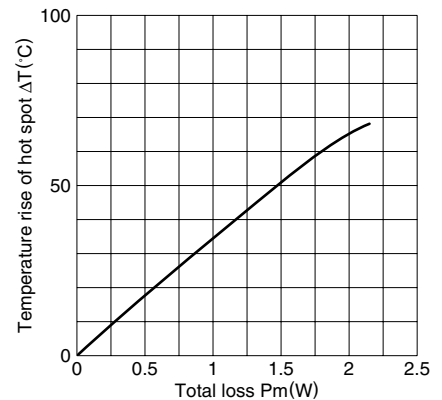

Note: The temperature rise is measured in the room whose temperature and humidity are fixed to 25°C and 45(%)RH, respectively. (approx. 400×300×300cm)

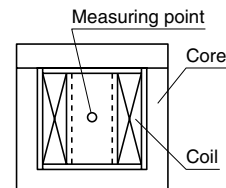

EI Series EI25 Cores

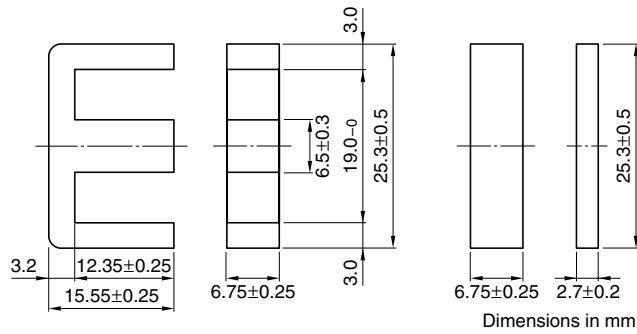

PARAMETER

Core factor	C1	mm ⁻¹	1.15
Effective magnetic path length	ℓ _e	mm	47.0
Effective cross-sectional area	A _e	mm ²	41.0
Effective core volume	V _e	mm ³	1930
Cross-sectional center pole area	A _{cp}	mm ²	43.9
Minimum cross-sectional area	A _{cp min.}	mm ²	40.3
Cross-sectional winding area of core	A _{cw}	mm ²	77.2
Weight (approx.)		g	9.8

Part No.	AL-value (nH/N ²)	Core loss (W) at 100°C 100kHz, 200mT	Calculated output power (forward converter mode)
PC40EI25-Z	2140±25% (1kHz, 0.5mA)* 2950 min. (100kHz, 200mT)	0.79 max.	68W (100kHz)

* Coil: ø0.35 2UEW 100Ts

NI limit vs. AL-value for PC40EI25 gapped core (Typical)

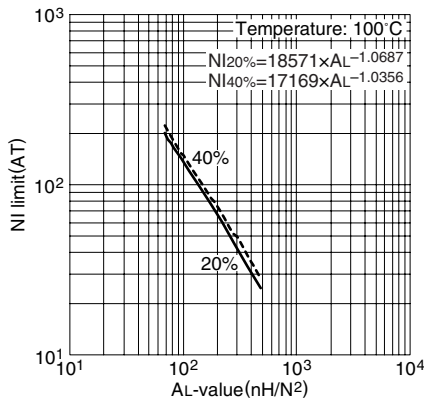

Note: NI limit shows the point where the exciting current is 20% and 40% away from its extended linear part.

AL-value vs. Air gap length for PC40EI25 core (Typical)

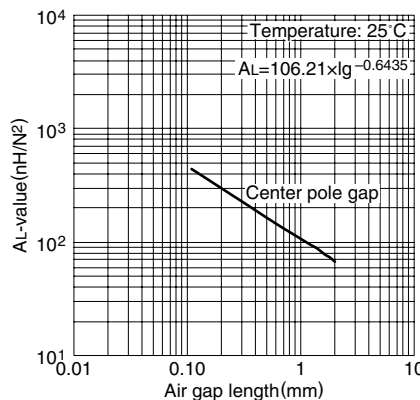

Measuring conditions • Coil: ø0.35 2UEW 100Ts
• Frequency: 1kHz
• Level: 0.5mA

Temperature rise vs. Total loss for EI25 core (Typical) (Ambient temperature: 25°C)

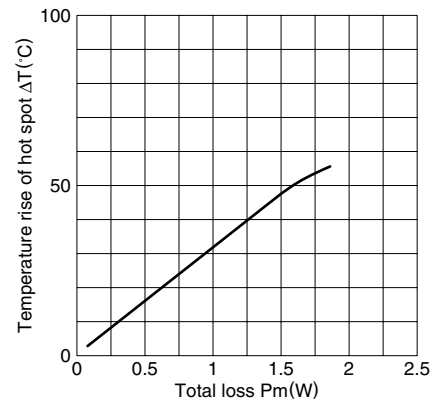

Note: The temperature rise is measured in the room whose temperature and humidity are fixed to 25°C and 45%RH, respectively. (approx. 400×300×300cm)

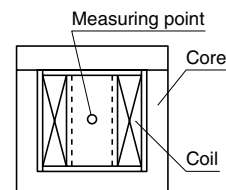

EI Series EI28 Cores(JIS FEI 28)

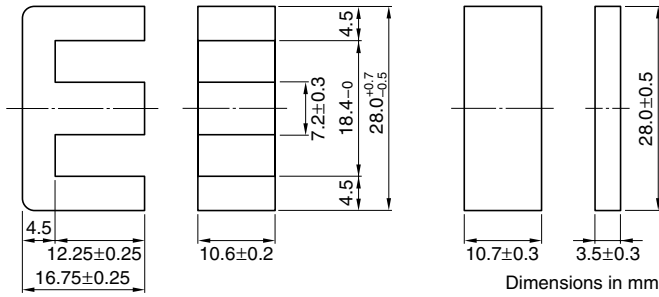

PARAMETER

Core factor	C1	mm ⁻¹	0.560
Effective magnetic path length	ℓ _e	mm	48.2
Effective cross-sectional area	A _e	mm ²	86.0
Effective core volume	V _e	mm ³	4150
Cross-sectional center pole area	A _{cp}	mm ²	76.3
Minimum cross-sectional area	A _{cp min.}	mm ²	71.8
Cross-sectional winding area of core	A _{cw}	mm ²	69.8
Weight (approx.)		g	22

Part No.	AL-value (nH/N ²)	Core loss (W) at 100°C 100kHz, 200mT	Calculated output power (forward converter mode)
PC40EI28-Z	4300±25% (1kHz, 0.5mA)* 6060 min. (100kHz, 200mT)	1.65 max.	107W (100kHz)

* Coil: ø0.35 2UEW 100Ts

NI limit vs. AL-value for PC40EI28 gapped core (Typical)

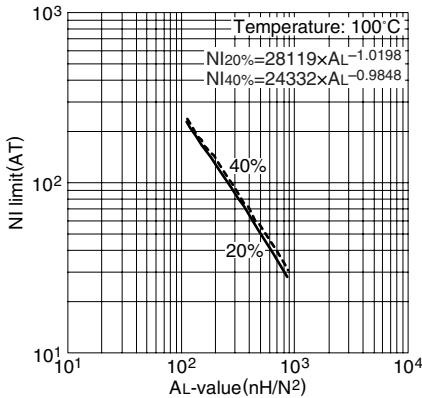

Note: NI limit shows the point where the exciting current is 20% and 40% away from its extended linear part.

AL-value vs. Air gap length for PC40EI28 core (Typical)

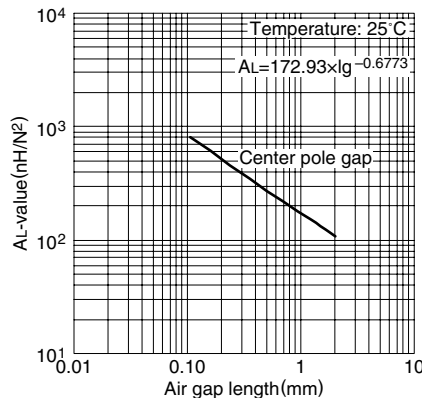

Measuring conditions • Coil: ø0.35 2UEW 100Ts
• Frequency: 1kHz
• Level: 0.5mA

**Temperature rise vs. Total loss for EI28 core (Typical)
(Ambient temperature: 25°C)**

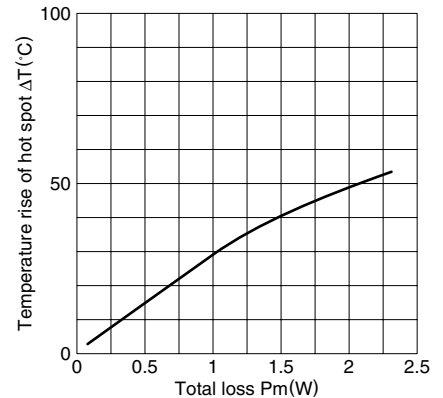

Note: The temperature rise is measured in the room whose temperature and humidity are fixed to 25°C and 45%RH, respectively. (approx. 400×300×300cm)

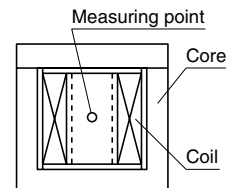

EI Series EI30 Cores(JIS FEI 30)

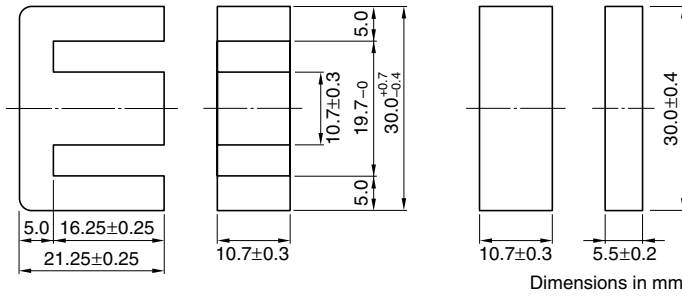

PARAMETER

Core factor	C1	mm ⁻¹	0.523
Effective magnetic path length	ℓ _e	mm	58.0
Effective cross-sectional area	A _e	mm ²	111
Effective core volume	V _e	mm ³	6440
Cross-sectional center pole area	A _{cp}	mm ²	114
Minimum cross-sectional area	A _{cp min.}	mm ²	108
Cross-sectional winding area of core	A _{cw}	mm ²	75.6
Weight (approx.)		g	34

Part No.	AL-value (nH/N ²)	Core loss (W) at 100°C 100kHz, 200mT	Calculated output power (forward converter mode)
PC40EI30-Z	4690±25% (1kHz, 0.5mA)* 6490 min. (100kHz, 200mT)	3.1 max.	155W (100kHz)

* Coil: ø0.35 2UEW 100Ts

NI limit vs. AL-value for PC40EI30 gapped core (Typical)

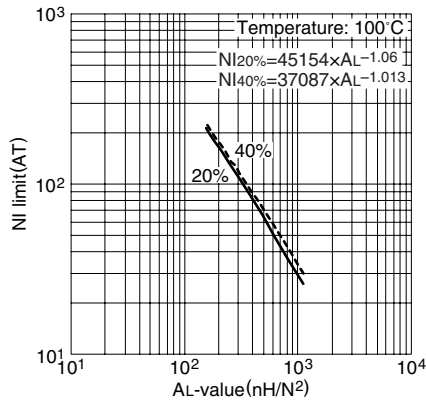

Note: NI limit shows the point where the exciting current is 20% and 40% away from its extended linear part.

AL-value vs. Air gap length for PC40EI30 core (Typical)

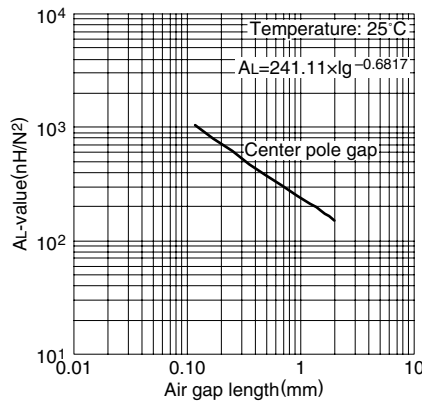

Measuring conditions • Coil: ø0.35 2UEW 100Ts
• Frequency: 1kHz
• Level: 0.5mA

Temperature rise vs. Total loss for EI30 core (Typical) (Ambient temperature: 25°C)

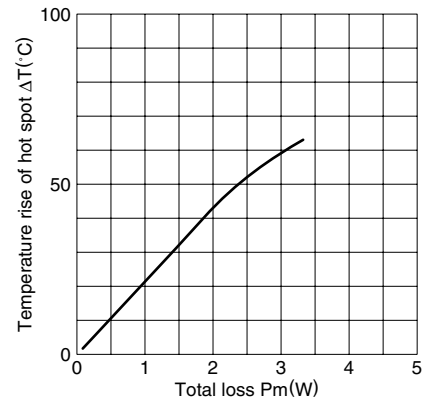

Note: The temperature rise is measured in the room whose temperature and humidity are fixed to 25°C and 45(%)RH, respectively. (approx. 400×300×300cm)

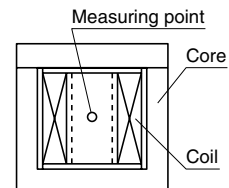

EI Series EI33/29/13 Cores

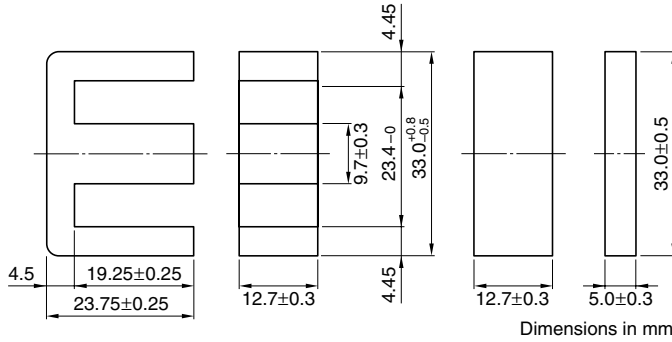

PARAMETER

Core factor	C1	mm ⁻¹	0.567
Effective magnetic path length	ℓ _e	mm	67.5
Effective cross-sectional area	A _e	mm ²	119
Effective core volume	V _e	mm ³	8030
Cross-sectional center pole area	A _{cp}	mm ²	123
Minimum cross-sectional area	A _{cp min.}	mm ²	117
Cross-sectional winding area of core	A _{cw}	mm ²	138.6
Weight (approx.)		g	41

Part No.	AL-value (nH/N ²)	Core loss (W) at 100°C 100kHz, 200mT	Calculated output power (forward converter mode)
PC40EI33/29/13-Z	4400±25% (1kHz, 0.5mA)* 5980 min. (100kHz, 200mT)	3.5 max.	206W (100kHz)

* Coil: ø0.35 2UEW 100Ts

NI limit vs. AL-value for PC40EI33/29/13 gapped core (Typical)

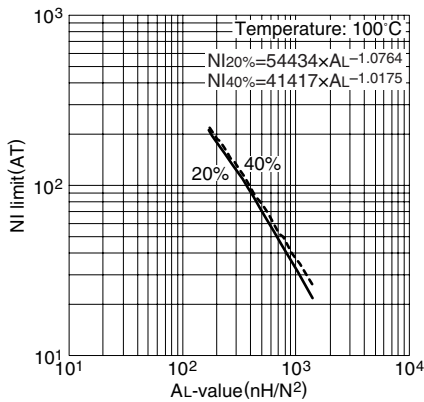

Note: NI limit shows the point where the exciting current is 20% and 40% away from its extended linear part.

AL-value vs. Air gap length for PC40EI33/29/13 core (Typical)

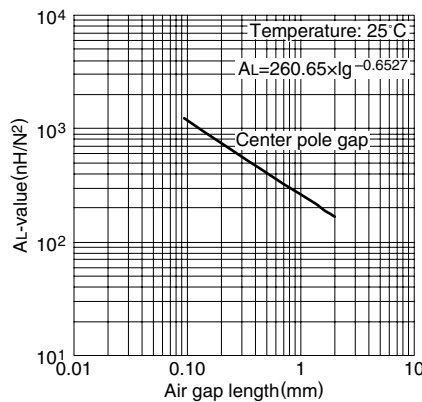

Measuring conditions • Coil: ø0.35 2UEW 100Ts
• Frequency: 1kHz
• Level: 0.5mA

Temperature rise vs. Total loss for EI33/29/13 core (Typical) (Ambient temperature: 25°C)

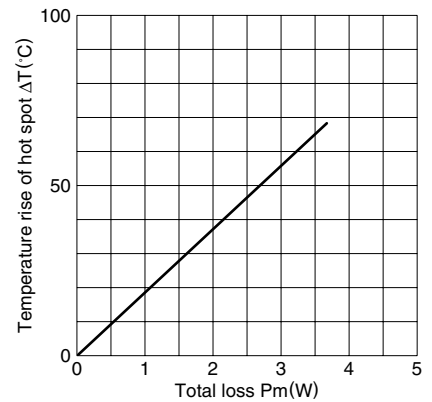

Note: The temperature rise is measured in the room whose temperature and humidity are fixed to 25°C and 45%RH, respectively. (approx. 400×300×300cm)

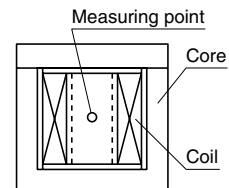

EI Series EI35 Cores(JIS FEI 35)

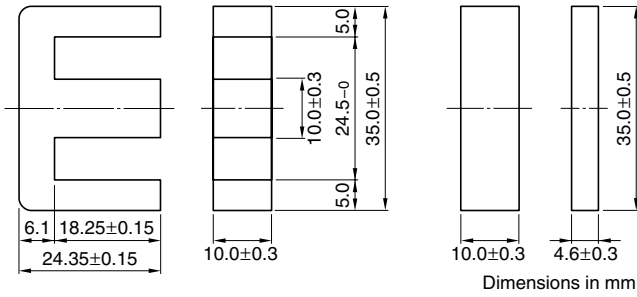

PARAMETER

Core factor	C1	mm ⁻¹	0.664
Effective magnetic path length	ℓ _e	mm	67.1
Effective cross-sectional area	A _e	mm ²	101
Effective core volume	V _e	mm ³	6780
Cross-sectional center pole area	A _{cp}	mm ²	100
Minimum cross-sectional area	A _{cp min.}	mm ²	94.1
Cross-sectional winding area of core	A _{cw}	mm ²	131.6
Weight (approx.)		g	36

Part No.	AL-value (nH/N ²)	Core loss (W) at 100°C 100kHz, 200mT	Calculated output power (forward converter mode)
PC40EI35-Z	3800±25% (1kHz, 0.5mA)* 5110 min. (100kHz, 200mT)	2.85 max.	218W (100kHz)

* Coil: ø0.35 2UEW 100Ts

NI limit vs. AL-value for PC40EI35 gapped core (Typical)

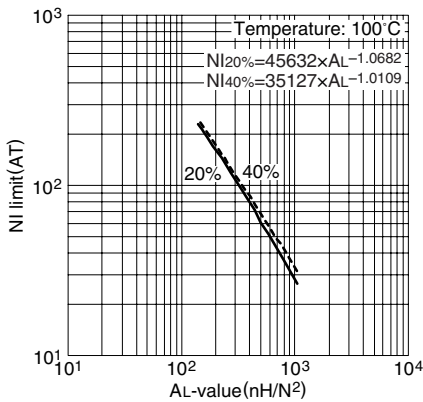

Note: NI limit shows the point where the exciting current is 20% and 40% away from its extended linear part.

AL-value vs. Air gap length for PC40EI35 core (Typical)

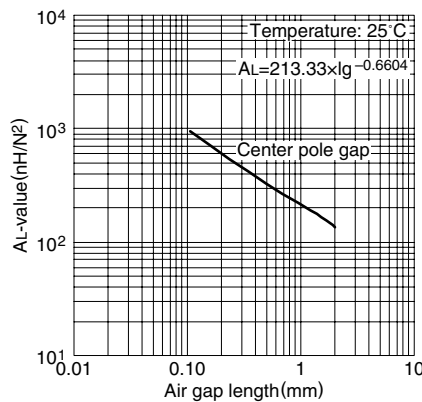

Measuring conditions • Coil: ø0.35 2UEW 100Ts
• Frequency: 1kHz
• Level: 0.5mA

Temperature rise vs. Total loss for EI35 core (Typical) (Ambient temperature: 25°C)

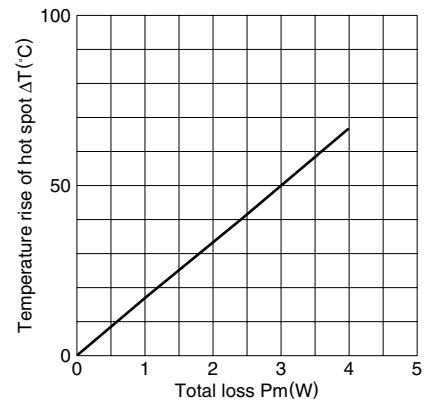

Note: The temperature rise is measured in the room whose temperature and humidity are fixed to 25°C and 45(%)RH, respectively. (approx. 400×300×300cm)

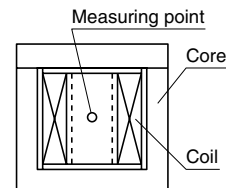

EI Series EI40 Cores(JIS FEI 40)

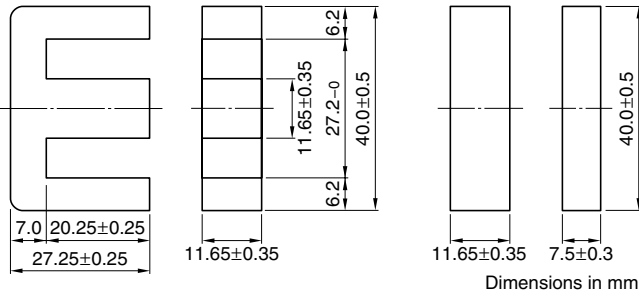

PARAMETER

Core factor	C1	mm ⁻¹	0.520
Effective magnetic path length	ℓ _e	mm	77.0
Effective cross-sectional area	A _e	mm ²	148
Effective core volume	V _e	mm ³	11400
Cross-sectional center pole area	A _{cp}	mm ²	136
Minimum cross-sectional area	A _{cp min.}	mm ²	128
Cross-sectional winding area of core	A _{cw}	mm ²	160.5
Weight (approx.)		g	60

Part No.	AL-value (nH/N ²)	Core loss (W) at 100°C 100kHz, 200mT	Calculated output power (forward converter mode)
PC40EI40-Z	4860±25% (1kHz, 0.5mA)* 6520 min. (100kHz, 200mT)	4.8 max.	348W (100kHz)

* Coil: ø0.35 2UEW 100Ts

NI limit vs. AL-value for PC40EI40 gapped core (Typical)

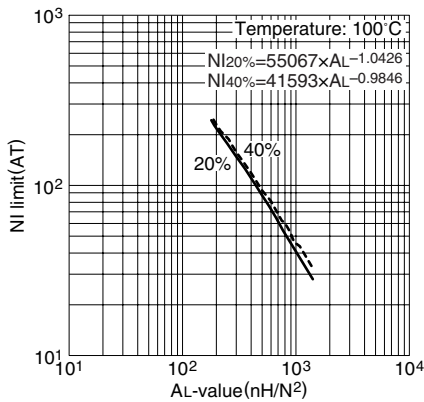

Note: NI limit shows the point where the exciting current is 20% and 40% away from its extended linear part.

AL-value vs. Air gap length for PC40EI40 core (Typical)

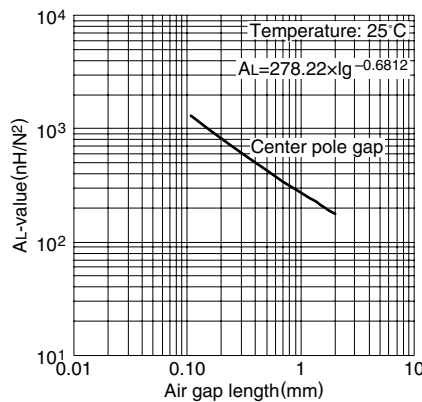

Measuring conditions • Coil: ø0.35 2UEW 100Ts
• Frequency: 1kHz
• Level: 0.5mA

Temperature rise vs. Total loss for EI40 core (Typical)
(Ambient temperature: 25°C)

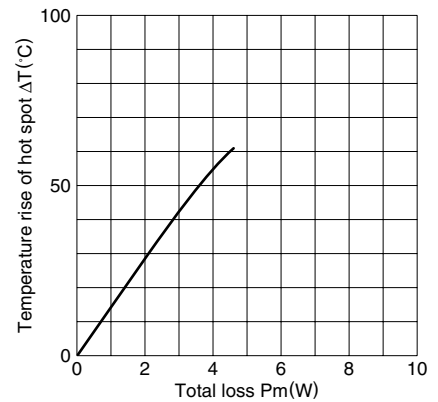

Note: The temperature rise is measured in the room whose temperature and humidity are fixed to 25°C and 45(%)RH, respectively. (approx. 400×300×300cm)

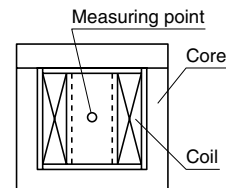

EI Series EI50 Cores(JIS FEI 50)

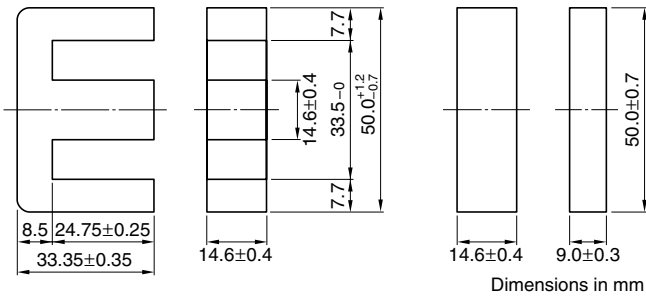

PARAMETER

Core factor	C1	mm ⁻¹	0.409
Effective magnetic path length	ℓ _e	mm	94.0
Effective cross-sectional area	A _e	mm ²	230
Effective core volume	V _e	mm ³	21620
Cross-sectional center pole area	A _{cp}	mm ²	213
Minimum cross-sectional area	A _{cp min.}	mm ²	202
Cross-sectional winding area of core	A _{cw}	mm ²	246.3
Weight (approx.)		g	115

Part No.	AL-value (nH/N ²)	Core loss (W) at 100°C 100kHz, 200mT	Calculated output power (forward converter mode)
PC40EI50-Z	6110±25% (1kHz, 0.5mA)* 8300 min. (100kHz, 200mT)	9.2 max.	508W (100kHz)

* Coil: ø0.35 2UEW 100Ts

NI limit vs. AL-value for PC40EI50 gapped core (Typical)

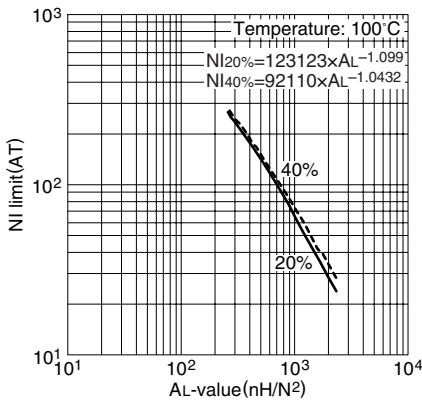

Note: NI limit shows the point where the exciting current is 20% and 40% away from its extended linear part.

AL-value vs. Air gap length for PC40EI50 core (Typical)

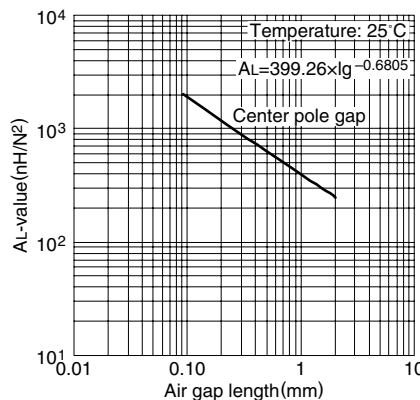

Measuring conditions • Coil: ø0.35 2UEW 100Ts
• Frequency: 1kHz
• Level: 0.5mA

Temperature rise vs. Total loss for EI50 core (Typical) (Ambient temperature: 25°C)

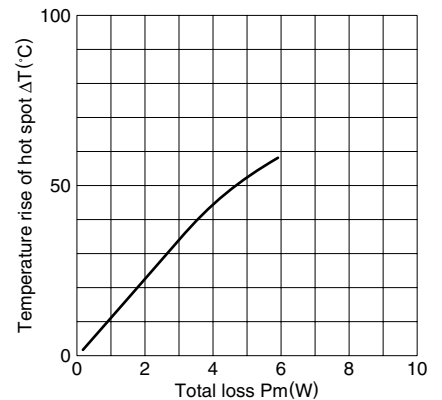

Note: The temperature rise is measured in the room whose temperature and humidity are fixed to 25°C and 45(%)RH, respectively. (approx. 400×300×300cm)

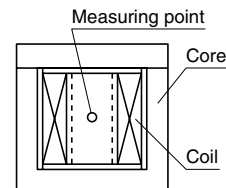

EI Series EI60 Cores(JIS FEI 60)

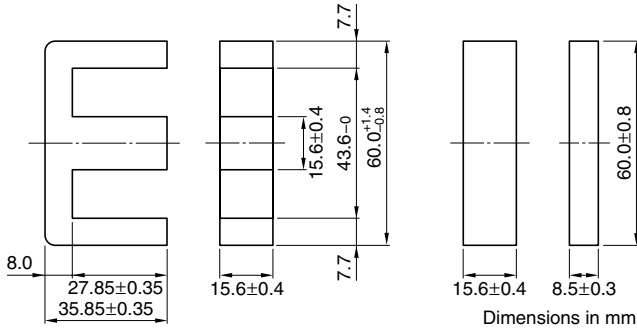

PARAMETER

Core factor	C1	mm ⁻¹	0.441
Effective magnetic path length	ℓ _e	mm	109
Effective cross-sectional area	A _e	mm ²	247
Effective core volume	V _e	mm ³	26900
Cross-sectional center pole area	A _{cp}	mm ²	243
Minimum cross-sectional area	A _{cp min.}	mm ²	231
Cross-sectional winding area of core	A _{cw}	mm ²	402.4
Weight (approx.)		g	139

Part No.	AL-value (nH/N ²)	Core loss (W) at 100°C 100kHz, 200mT	Calculated output power (forward converter mode)
PC40EI60-Z	5670±25% (1kHz, 0.5mA)* 7690 min. (100kHz, 200mT)	12.5 max.	618W (100kHz)

* Coil: ø0.35 2UEW 100Ts

NI limit vs. AL-value for PC40EI60 gapped core (Typical)

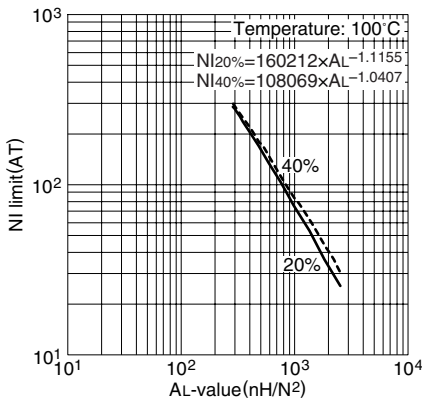

Note: NI limit shows the point where the exciting current is 20% and 40% away from its extended linear part.

AL-value vs. Air gap length for PC40EI60 core (Typical)

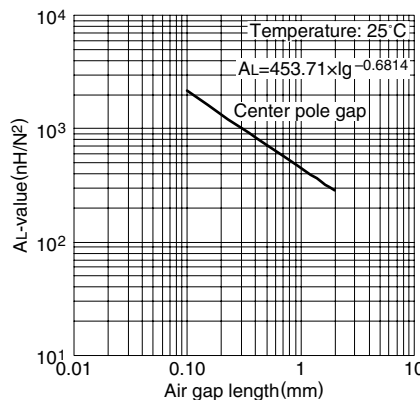

Measuring conditions • Coil: ø0.35 2UEW 100Ts
• Frequency: 1kHz
• Level: 0.5mA

Temperature rise vs. Total loss for EI60 core (Typical)
(Ambient temperature: 25°C)

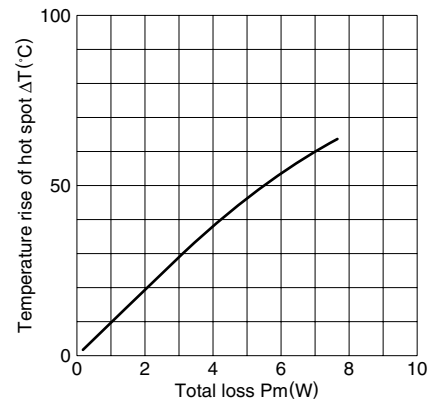

Note: The temperature rise is measured in the room whose temperature and humidity are fixed to 25°C and 45%(%)RH, respectively. (approx. 400×300×300cm)

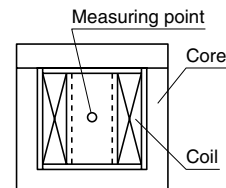

EE Series EE10/11 Cores(JIS FEE 10.2)

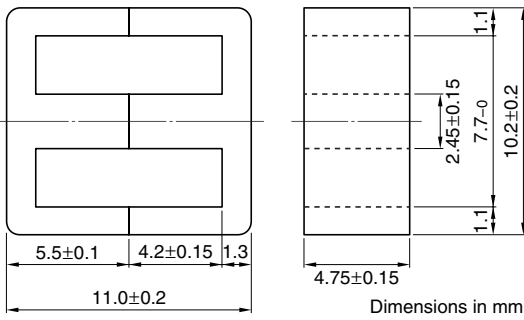

PARAMETER

Core factor	C1	mm ⁻¹	2.16
Effective magnetic path length	ℓ _e	mm	26.1
Effective cross-sectional area	A _e	mm ²	12.1
Effective core volume	V _e	mm ³	315
Cross-sectional center pole area	A _{cp}	mm ²	11.6
Minimum cross-sectional area	A _{cp min.}	mm ²	10.6
Cross-sectional winding area of core	A _{cw}	mm ²	23.3
Weight (approx.)		g	1.5

Part No.	AL-value (nH/N ²)	Core loss (W) at 100°C 100kHz, 200mT	Calculated output power (forward converter mode)
PC40EE10/11-Z	850±25% (1kHz, 0.5mA)* 1450 min. (100kHz, 200mT)	0.14 max.	9.4W (100kHz)

* Coil: ø0.18 2UEW 100Ts

NI limit vs. AL-value for PC40EE10/11 gapped core (Typical)

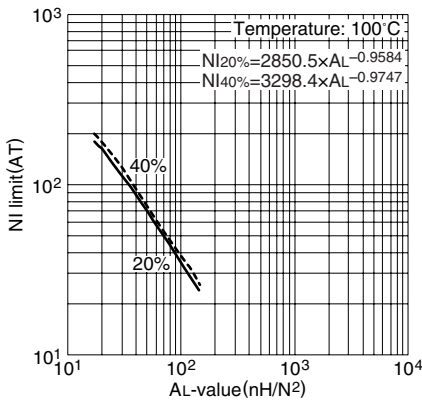

Note: NI limit shows the point where the exciting current is 20% and 40% away from its extended linear part.

AL-value vs. Air gap length for PC40EE10/11 core (Typical)

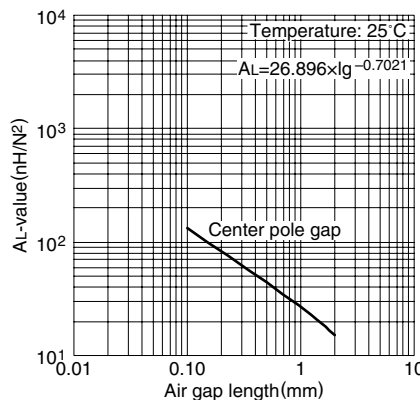

Measuring conditions • Coil: ø0.18 2UEW 100Ts
• Frequency: 1kHz
• Level: 0.5mA

**Temperature rise vs. Total loss for EE10/11 core (Typical)
(Ambient temperature: 25°C)**

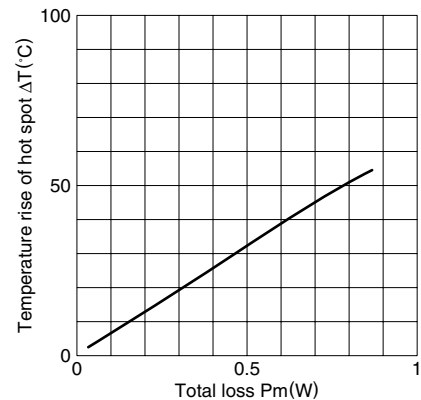

Note: The temperature rise is measured in the room whose temperature and humidity are fixed to 25°C and 45(%)RH, respectively. (approx. 400×300×300cm)

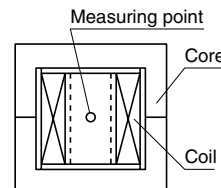

EE Series EE13 Cores

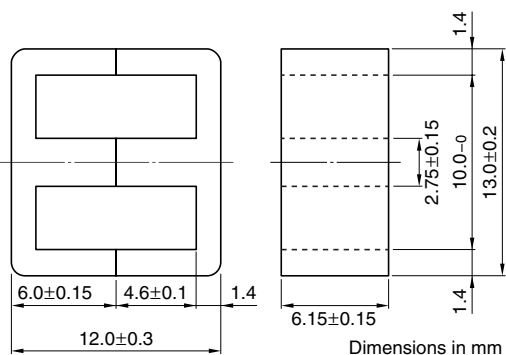

PARAMETER

Core factor	C1	mm ⁻¹	1.77
Effective magnetic path length	ℓ _e	mm	30.2
Effective cross-sectional area	A _e	mm ²	17.1
Effective core volume	V _e	mm ³	517
Cross-sectional center pole area	A _{cp}	mm ²	16.9
Minimum cross-sectional area	A _{cp min.}	mm ²	15.6
Cross-sectional winding area of core	A _{cw}	mm ²	34.3
Weight (approx.)		g	2.7

Part No.	AL-value (nH/N ²)	Core loss (W) at 100°C 100kHz, 200mT	Calculated output power (forward converter mode)
PC40EE13-Z	1130±25% (1kHz, 0.5mA)* 1770 min. (100kHz, 200mT)	0.235 max.	17W (100kHz)

* Coil: ø0.18 2UEW 100Ts

NI limit vs. AL-value for PC40EE13 gapped core (Typical)

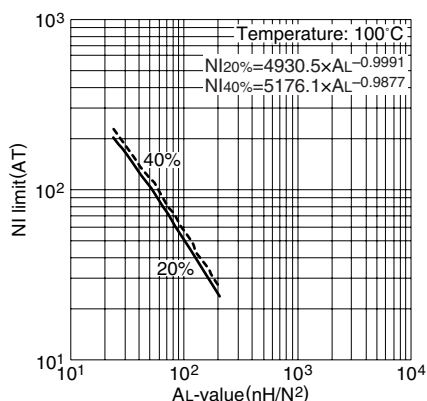

Note: NI limit shows the point where the exciting current is 20% and 40% away from its extended linear part.

AL-value vs. Air gap length for PC40EE13 core (Typical)

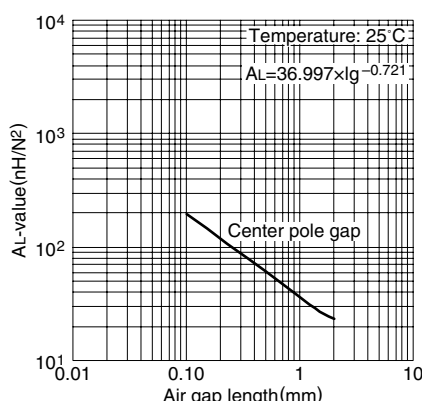

Measuring conditions • Coil: ø0.18 2UEW 100Ts
• Frequency: 1kHz
• Level: 0.5mA

**Temperature rise vs. Total loss for EE13 core (Typical)
(Ambient temperature: 25°C)**

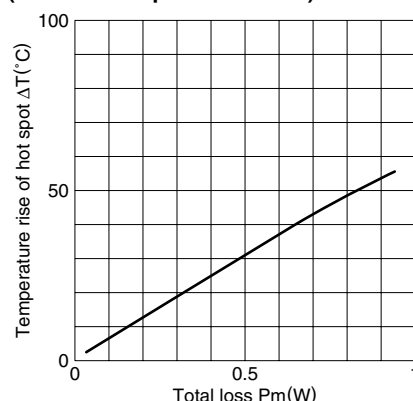

Note: The temperature rise is measured in the room whose temperature and humidity are fixed to 25°C and 45(%)RH, respectively. (approx. 400×300×300cm)

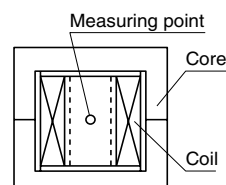

EE Series EE16 Cores

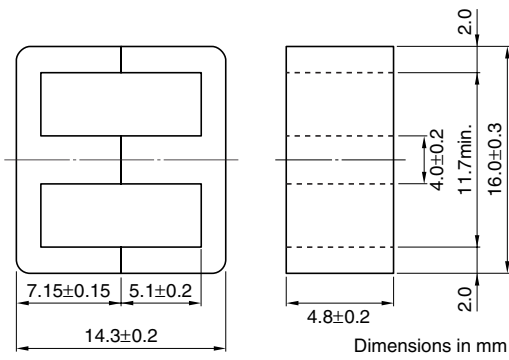

PARAMETER

Core factor	C1	mm ⁻¹	1.82
Effective magnetic path length	ℓ _e	mm	34.5
Effective cross-sectional area	A _e	mm ²	19.0
Effective core volume	V _e	mm ³	656
Cross-sectional center pole area	A _{cp}	mm ²	19.2
Minimum cross-sectional area	A _{cp min.}	mm ²	17.5
Cross-sectional winding area of core	A _{cw}	mm ²	41.4
Weight (approx.)		g	3.3

Part No.	AL-value (nH/N ²)	Core loss (W) at 100°C 100kHz, 200mT	Calculated output power (forward converter mode)
PC40EE16-Z	1140±25% (1kHz, 0.5mA)*	0.31 max.	24W

* Coil: ø0.18 2UEW 100Ts

NI limit vs. AL-value for PC40EE16 gapped core (Typical)

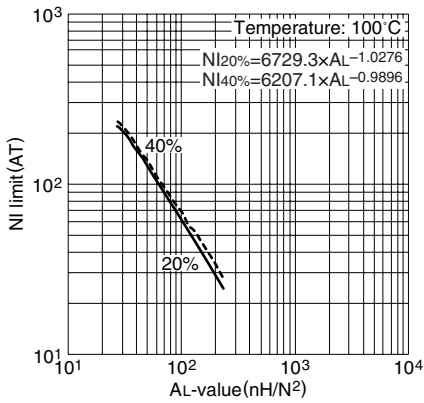

Note: NI limit shows the point where the exciting current is 20% and 40% away from its extended linear part.

AL-value vs. Air gap length for PC40EE16 core (Typical)

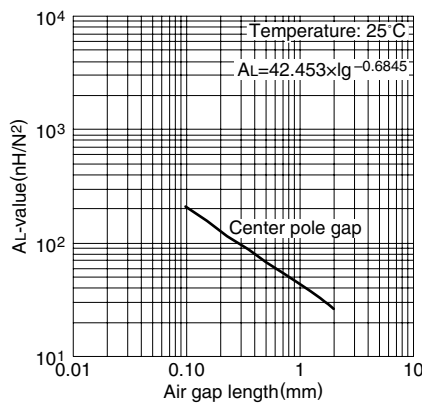

Measuring conditions • Coil: ø0.18 2UEW 100Ts
 • Frequency: 1kHz
 • Level: 0.5mA

EE Series SEE16 Cores

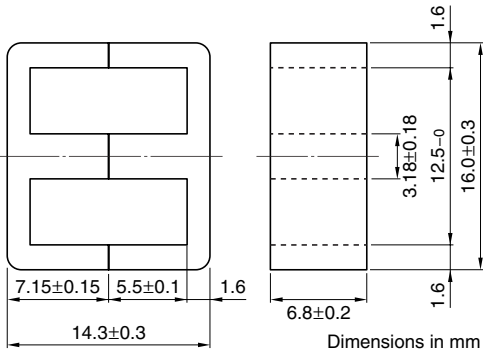

PARAMETER

Core factor	C1	mm ⁻¹	1.69
Effective magnetic path length	ℓ _e	mm	36.6
Effective cross-sectional area	A _e	mm ²	21.7
Effective core volume	V _e	mm ³	795
Cross-sectional center pole area	A _{cp}	mm ²	21.6
Minimum cross-sectional area	A _{cp min.}	mm ²	19.8
Cross-sectional winding area of core	A _{cw}	mm ²	52.9
Weight (approx.)		g	4.1

Part No.	AL-value (nH/N ²)	Core loss (W) at 100°C 100kHz, 200mT	Calculated output power (forward converter mode)
PC40SEE16-Z	1240±25% (1kHz, 0.5mA)* 1850 min. (100kHz, 200mT)	0.37 max.	32W (100kHz)

* Coil: ø0.23 2UEW 100Ts

NI limit vs. AL-value for PC40SEE16 gapped core (Typical)

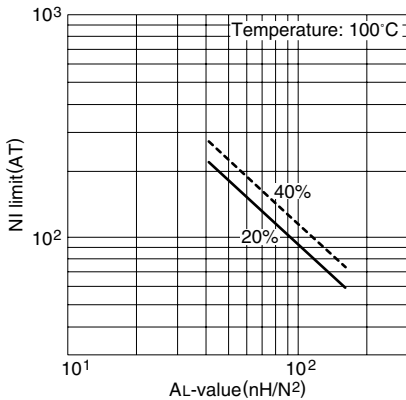

Note: NI limit shows the point where the exciting current is 20% and 40% away from its extended linear part.

AL-value vs. Air gap length for PC40SEE16 core (Typical)

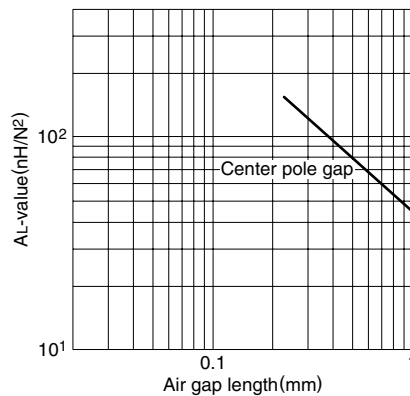

Measuring conditions

- Coil: ø0.23 2UEW 100Ts
- Frequency: 1kHz
- Level: 0.5mA

Temperature rise vs. Total loss for SEE16 core (Typical)
(Ambient temperature: 25°C)

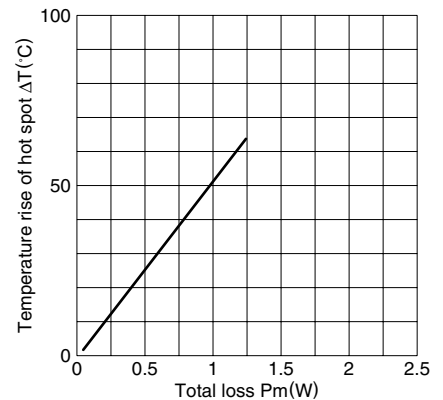

Note: The temperature rise is measured in the room whose temperature and humidity are fixed to 25°C and 45(%)RH, respectively. (approx. 400×300×300cm)

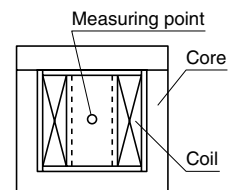

EE Series EE19 Cores

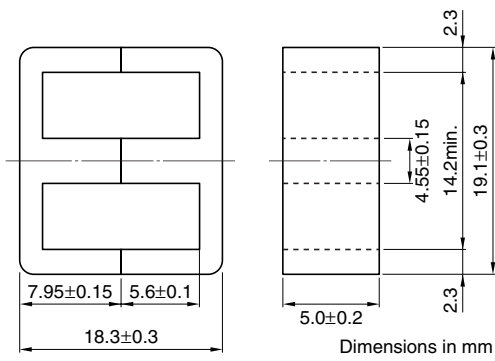

PARAMETER

Core factor	C1	mm ⁻¹	1.71
Effective magnetic path length	ℓ _e	mm	39.4
Effective cross-sectional area	A _e	mm ²	23.0
Effective core volume	V _e	mm ³	906
Cross-sectional center pole area	A _{cp}	mm ²	22.8
Minimum cross-sectional area	A _{cp min.}	mm ²	21.1
Cross-sectional winding area of core	A _{cw}	mm ²	55.8
Weight (approx.)		g	4.8

Part No.	AL-value (nH/N ²)	Core loss (W) at 100°C		Calculated output power (forward converter mode)
		100kHz, 200mT		
PC40EE19-Z	1250±25% (1kHz, 0.5mA)*	0.42		28W

* Coil: ø0.18 2UEW 100Ts

NI limit vs. AL-value for PC40EE19 gapped core (Typical)

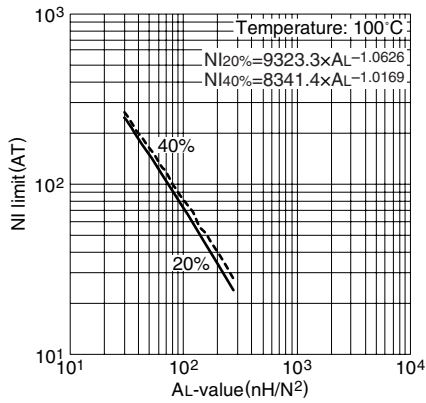

Note: NI limit shows the point where the exciting current is 20% and 40% away from its extended linear part.

AL-value vs. Air gap length for PC40EE19 core (Typical)

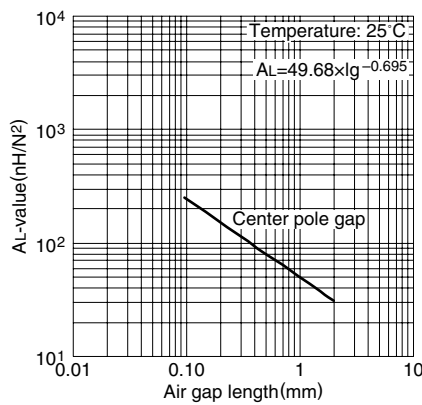

Measuring conditions • Coil: ø0.18 2UEW 100Ts
 • Frequency: 1kHz
 • Level: 0.5mA

EE Series EE20/20/5 Cores(DIN 41295)

Based on DIN 41295.

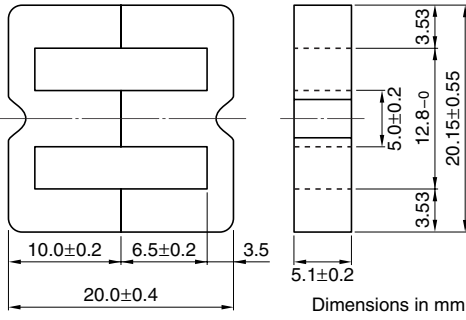

PARAMETER

Core factor	C1	mm ⁻¹	1.38
Effective magnetic path length	ℓ _e	mm	43.0
Effective cross-sectional area	A _e	mm ²	31.0
Effective core volume	V _e	mm ³	1340
Cross-sectional center pole area	A _{cp}	mm ²	25.5
Minimum cross-sectional area	A _{cp min.}	mm ²	23.5
Cross-sectional winding area of core	A _{cw}	mm ²	41.3
Weight (approx.)		g	7.5

Part No.	AL-value (nH/N ²)	Core loss (W) at 100°C 100kHz, 200mT	Calculated output power (forward converter mode)
PC40EE20/20/5-Z	1400±25% (1kHz, 0.5mA)* 2270 min. (100kHz, 200mT)	0.51 max.	41W (100kHz)

* Coil: ø0.23 2UEW 100Ts

NI limit vs. AL-value for PC40EE20/20/5 gapped core (Typical)

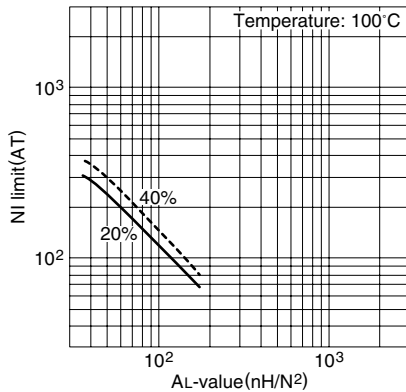

Note: NI limit shows the point where the exciting current is 20% and 40% away from its extended linear part.

AL-value vs. Air gap length for PC40EE20/20/5 core (Typical)

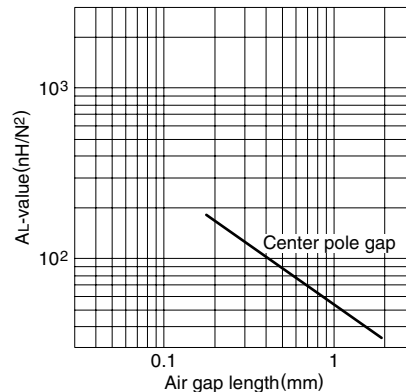

Measuring conditions • Coil: ø0.23 2UEW 100Ts
• Frequency: 1kHz
• Level: 0.5mA

**Temperature rise vs. Total loss for EE20/20/5 core (Typical)
(Ambient temperature: 25°C)**

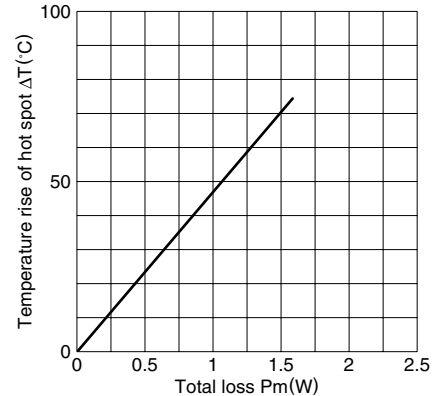

Note: The temperature rise is measured in the room whose temperature and humidity are fixed to 25°C and 45%RH, respectively. (approx. 400×300×300cm)

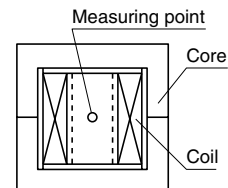

EE Series EE25/19 Cores

Based on standard U. S. lamination size.

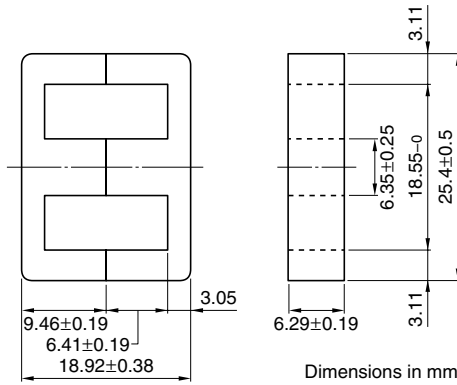

PARAMETER

Core factor	C1	mm ⁻¹	1.22
Effective magnetic path length	ℓ _e	mm	48.7
Effective cross-sectional area	A _e	mm ²	40.0
Effective core volume	V _e	mm ³	1950
Cross-sectional center pole area	A _{cp}	mm ²	39.9
Minimum cross-sectional area	A _{cp min.}	mm ²	37.2
Cross-sectional winding area of core	A _{cw}	mm ²	79.0
Weight (approx.)		g	9.1

Part No.	AL-value (nH/N ²)	Core loss (W) at 100°C 100kHz, 200mT	Calculated output power (forward converter mode)
PC40EE25/19-Z	2000±25% (1kHz, 0.5mA)* 2570 min. (100kHz, 200mT)	0.86 max.	70W (100kHz)

* Coil: ø0.23 2UEW 100Ts

NI limit vs. AL-value for PC40EE25/19 gapped core (Typical)

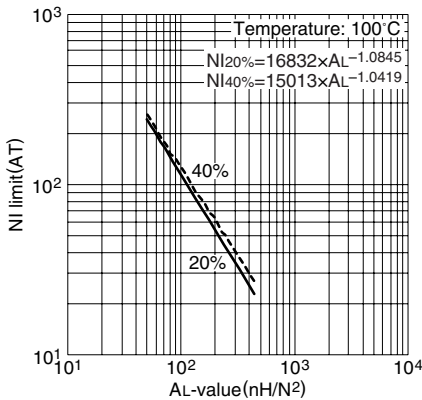

Note: NI limit shows the point where the exciting current is 20% and 40% away from its extended linear part.

AL-value vs. Air gap length for PC40EE25/19 core (Typical)

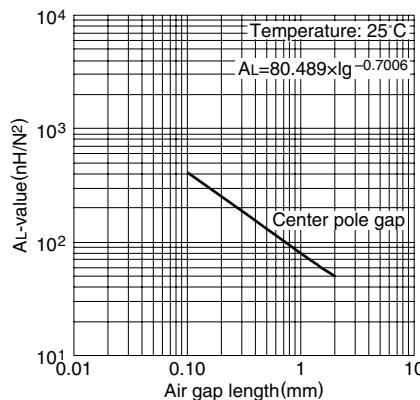

Measuring conditions • Coil: ø0.23 2UEW 100Ts
• Frequency: 1kHz
• Level: 0.5mA

Temperature rise vs. Total loss for EE25/19 core (Typical) (Ambient temperature: 25°C)

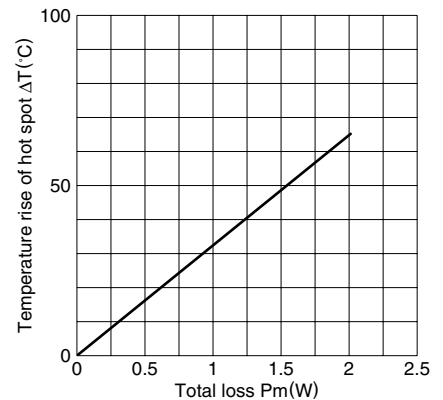

Note: The temperature rise is measured in the room whose temperature and humidity are fixed to 25°C and 45(%)RH, respectively. (approx. 400×300×300cm)

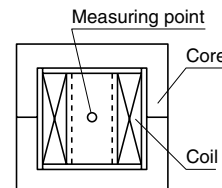

EE Series EE30 Cores(DIN 41295)

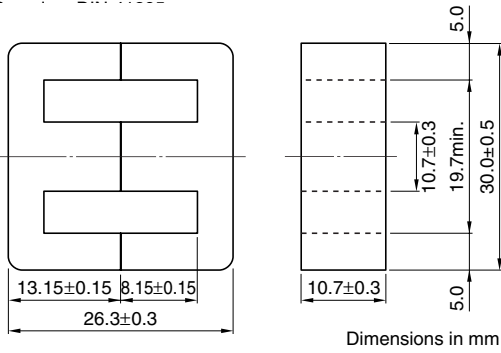

PARAMETER

Core factor	C1	mm ⁻¹	0.529
Effective magnetic path length	ℓ _e	mm	57.7
Effective cross-sectional area	A _e	mm ²	109.0
Effective core volume	V _e	mm ³	6290
Cross-sectional center pole area	A _{cp}	mm ²	114
Minimum cross-sectional area	A _{cp min.}	mm ²	108
Cross-sectional winding area of core	A _{cw}	mm ²	75.8
Weight (approx.)		g	32

Part No.	AL-value (nH/N ²)	Core loss (W) at 100°C 100kHz, 200mT	Calculated output power (forward converter mode)
PC40EE30-Z	4690±25% (1kHz, 0.5mA)*	2.90 max.	133W

* Coil: ø0.35 2UEW 100Ts

NI limit vs. AL-value for PC40EE30 gapped core (Typical)

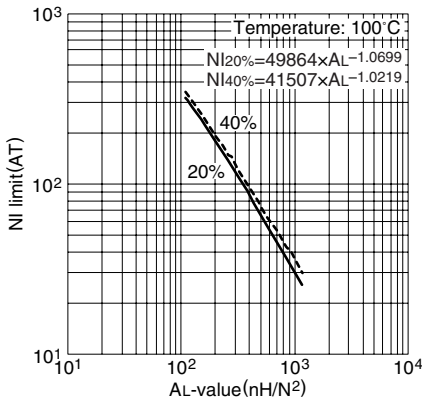

Note: NI limit shows the point where the exciting current is 20% and 40% away from its extended linear part.

AL-value vs. Air gap length for PC40EE30 core (Typical)

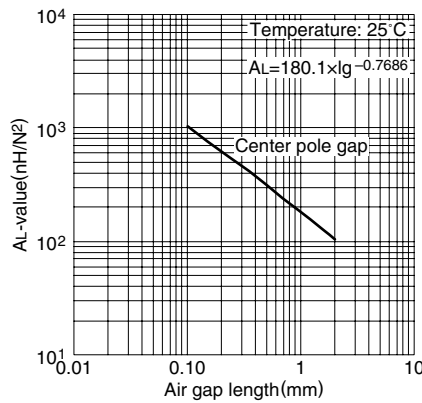

Measuring conditions • Coil: ø0.35 2UEW 100Ts
• Frequency: 1kHz
• Level: 0.5mA

EE Series EE40 Cores

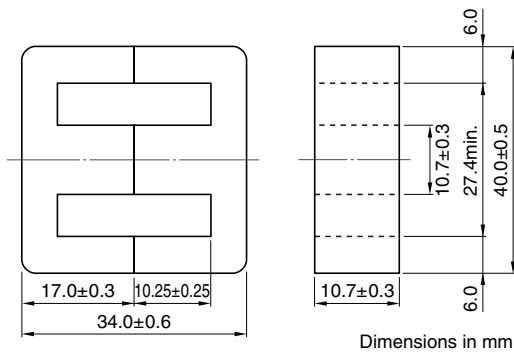

PARAMETER

Core factor	C1	mm ⁻¹	0.606
Effective magnetic path length	ℓ _e	mm	77.3
Effective cross-sectional area	A _e	mm ²	128
Effective core volume	V _e	mm ³	9890
Cross-sectional center pole area	A _{cp}	mm ²	114
Minimum cross-sectional area	A _{cp min.}	mm ²	108
Cross-sectional winding area of core	A _{cw}	mm ²	164
Weight (approx.)		g	50

Part No.	AL-value (nH/N ²)	Core loss (W) at 100°C		Calculated output power (forward converter mode)
		100kHz, 200mT		
PC40EE40-Z	4150±25% (1kHz, 0.5mA)*	4.20 max.		210W

* Coil: ø0.18 2UEW 100Ts

NI limit vs. AL-value for PC40EE40 gapped core (Typical)

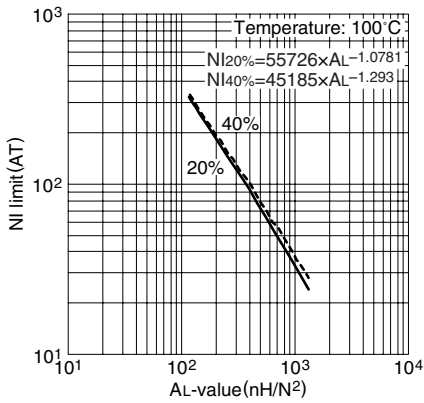

Note: NI limit shows the point where the exciting current is 20% and 40% away from its extended linear part.

AL-value vs. Air gap length for PC40EE40 core (Typical)

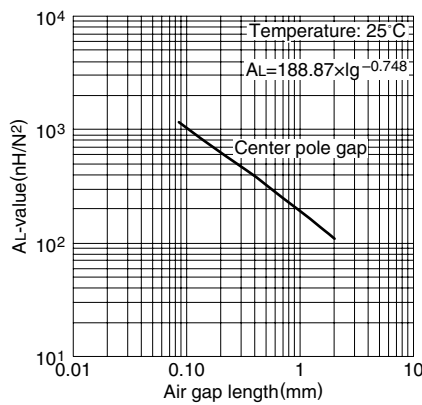

Measuring conditions • Coil: ø0.18 2UEW 100Ts
 • Frequency: 1kHz
 • Level: 0.5mA

EE Series EE42/42/15 Cores(DIN 41295)

Based on DIN 41295

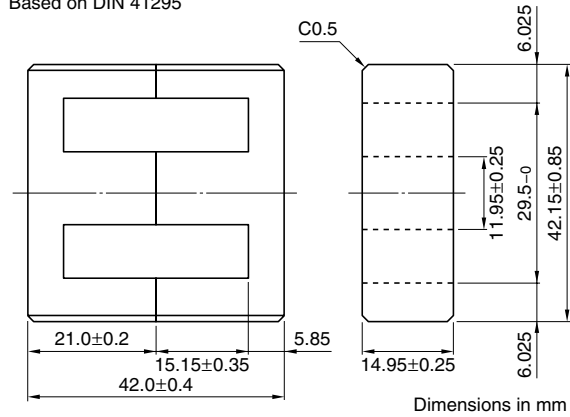

PARAMETER

Core factor	C1	mm ⁻¹	0.533
Effective magnetic path length	ℓ _e	mm	97.0
Effective cross-sectional area	A _e	mm ²	182
Effective core volume	V _e	mm ³	17600
Cross-sectional center pole area	A _{cp}	mm ²	179
Minimum cross-sectional area	A _{cp min.}	mm ²	172
Cross-sectional winding area of core	A _{cw}	mm ²	275
Weight (approx.)		g	80

Part No.	AL-value (nH/N ²)	Core loss (W) at 100°C 100kHz, 200mT	Calculated output power (forward converter mode)
PC40EE42/42/15-Z	4700±25% (1kHz, 0.5mA)* 7050 min. (100kHz, 200mT)	8.0 max.	419W (100kHz)

* Coil: ø0.35 2UEW 100Ts

NI limit vs. AL-value for PC40EE42/42/15 gapped core (Typical)

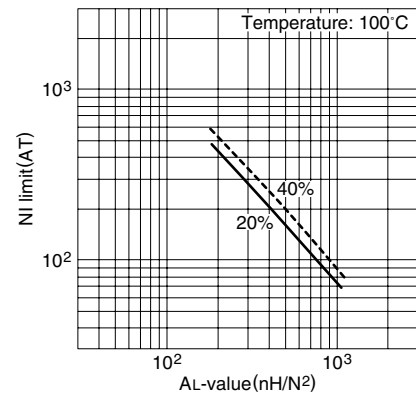

Note: NI limit shows the point where the exciting current is 20% and 40% away from its extended linear part.

AL-value vs. Air gap length for PC40EE42/42/15 core (Typical)

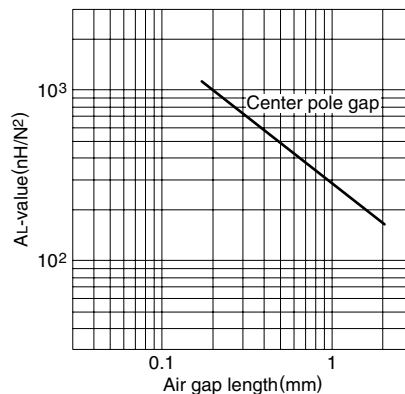

Measuring conditions • Coil: ø0.35 2UEW 100Ts
• Frequency: 1kHz
• Level: 0.5mA

**Temperature rise vs. Total loss for EE42/42/15 core (Typical)
(Ambient temperature: 25°C)**

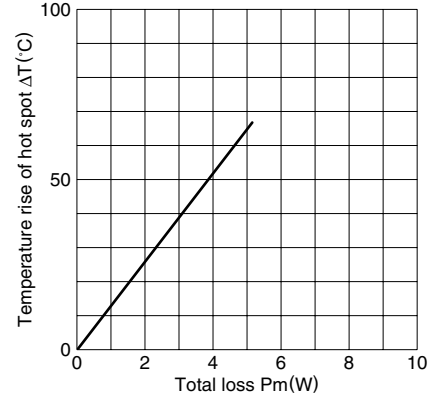

Note: The temperature rise is measured in the room whose temperature and humidity are fixed to 25°C and 45%RH, respectively. (approx. 400×300×300cm)

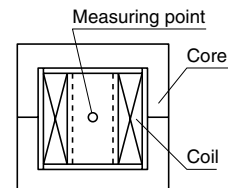

EE Series EE50 Cores

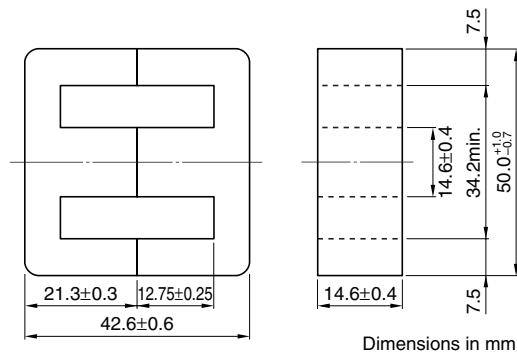

PARAMETER

Core factor	C1	mm ⁻¹	0.425
Effective magnetic path length	ℓ _e	mm	95.8
Effective cross-sectional area	A _e	mm ²	226
Effective core volume	V _e	mm ³	21600
Cross-sectional center pole area	A _{cp}	mm ²	213
Minimum cross-sectional area	A _{cp min.}	mm ²	202
Cross-sectional winding area of core	A _{cw}	mm ²	262
Weight (approx.)		g	116

Part No.	AL-value (nH/N ²)	Core loss (W) at 100°C		Calculated output power (forward converter mode)
		100kHz, 200mT		
PC40EE50-Z	6110±25% (1kHz, 0.5mA)*	9.40 max.		420W

* Coil: ø0.18 2UEW 100Ts

NI limit vs. AL-value for PC40EE50 gapped core (Typical)

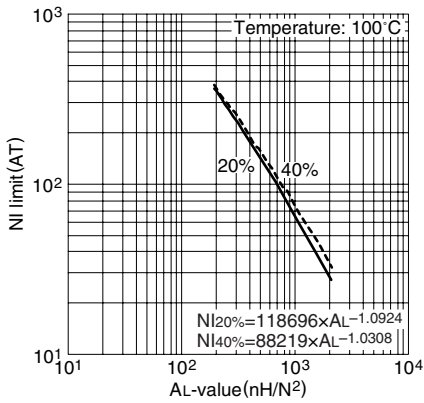

Note: NI limit shows the point where the exciting current is 20% and 40% away from its extended linear part.

AL-value vs. Air gap length for PC40EE50 core (Typical)

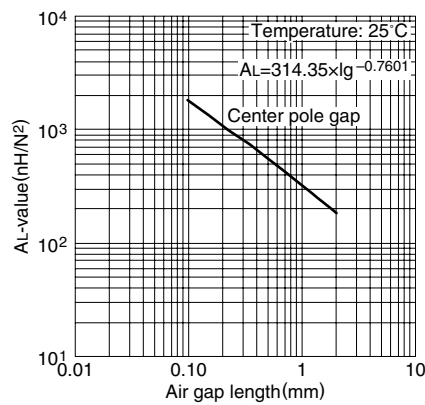

Measuring conditions • Coil: ø0.18 2UEW 100Ts
 • Frequency: 1kHz
 • Level: 0.5mA

EE Series EE55/55/21 Cores(DIN 41295)

Based on DIN 41295

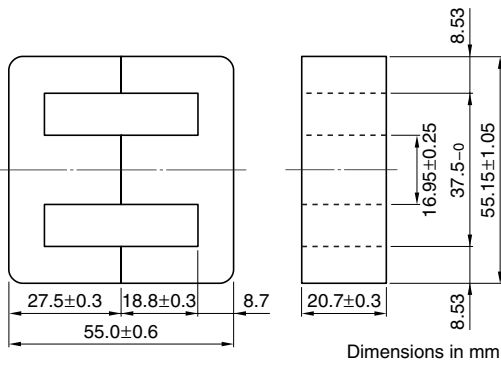

PARAMETER

Core factor	C1	mm ⁻¹	0.348
Effective magnetic path length	ℓ _e	mm	123
Effective cross-sectional area	A _e	mm ²	354
Effective core volume	V _e	mm ³	43700
Cross-sectional center pole area	A _{cp}	mm ²	351
Minimum cross-sectional area	A _{cp min.}	mm ²	341
Cross-sectional winding area of core	A _{cw}	mm ²	397
Weight (approx.)		g	234

Part No.	AL-value (nH/N ²)	Core loss (W) at 100°C 100kHz, 200mT	Calculated output power (forward converter mode)
PC40EE55/55/21-Z	7100±25% (1kHz, 0.5mA)* 10830 min. (100kHz, 200mT)	11.0 max.	814W (100kHz)

* Coil: ø0.35 2UEW 100Ts

NI limit vs. AL-value for PC40EE55/55/21 gapped core (Typical)

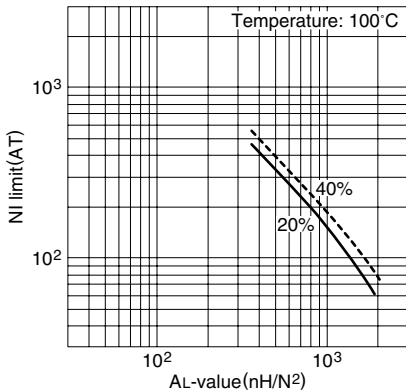

Note: NI limit shows the point where the exciting current is 20% and 40% away from its extended linear part.

AL-value vs. Air gap length for PC40EE55/55/21 core (Typical)

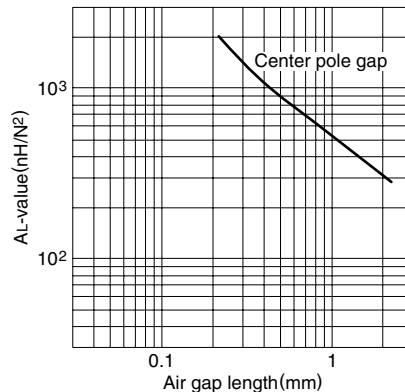

Measuring conditions • Coil: ø0.35 2UEW 100Ts
• Frequency: 1kHz
• Level: 0.5mA

Temperature rise vs. Total loss for EE55/55/21 core (Typical) (Ambient temperature: 25°C)

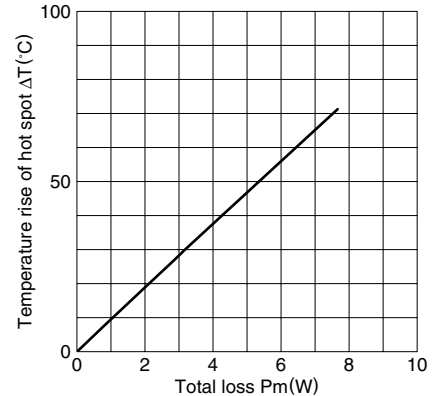

Note: The temperature rise is measured in the room whose temperature and humidity are fixed to 25°C and 45(%)RH, respectively. (approx. 400×300×300cm)

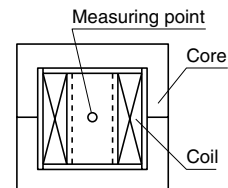

EE Series EE60 Cores

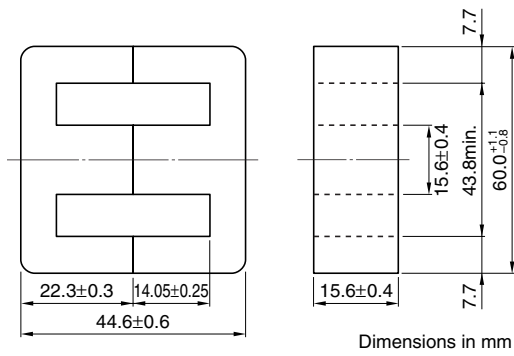

PARAMETER

Core factor	C1	mm ⁻¹	0.446
Effective magnetic path length	ℓ _e	mm	110
Effective cross-sectional area	A _e	mm ²	247
Effective core volume	V _e	mm ³	27100
Cross-sectional center pole area	A _{cp}	mm ²	243
Minimum cross-sectional area	A _{cp min.}	mm ²	231
Cross-sectional winding area of core	A _{cw}	mm ²	407
Weight (approx.)		g	135

Part No.	AL-value (nH/N ²)	Core loss (W) at 100°C 100kHz, 200mT	Calculated output power (forward converter mode)
PC40EE60-Z	5670±25% (1kHz, 0.5mA)*	12.5 max.	550W

* Coil: ø0.18 2UEW 100Ts

NI limit vs. AL-value for PC40EE60 gapped core (Typical)

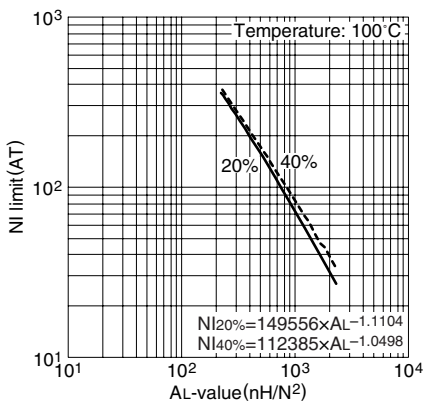

Note: NI limit shows the point where the exciting current is 20% and 40% away from its extended linear part.

AL-value vs. Air gap length for PC40EE60 core (Typical)

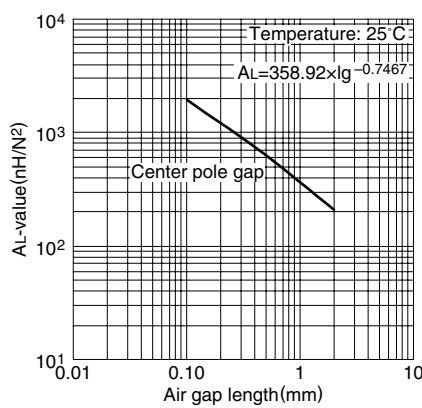

Measuring conditions • Coil: ø0.18 2UEW 100Ts
• Frequency: 1kHz
• Level: 0.5mA

EER Series EER25.5 Cores(JIS FEER 25.5A)

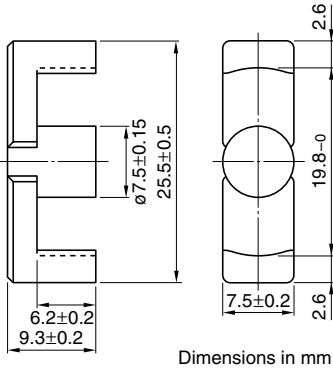

PARAMETER

Core factor	C1	mm ⁻¹	1.08
Effective magnetic path length	ℓ _e	mm	48.2
Effective cross-sectional area	A _e	mm ²	44.8
Effective core volume	V _e	mm ³	2160
Cross-sectional center pole area	A _{cp}	mm ²	44.2
Minimum cross-sectional center pole area	A _{cp min.}	mm ²	42.4
Cross-sectional winding area of core	A _{cw}	mm ²	79.4
Weight (approx.)		g	11

Part No.	AL-value (nH/N ²)	Core loss (W) 100kHz, 200mT	Calculated output power (forward converter mode)
PC40EER25.5-Z	1920±25% (1kHz, 0.5mA)* 2910 min. (100kHz, 200mT)	0.98 max.(100°C)	87W (100kHz)
PC95EER25.5-Z	1920±25% (1kHz, 0.5mA)* 2700±25%	1.1/0.9/1.1(25°C/80°C/120°C)	96W

* Coil: ø0.35 2UEW 100Ts

NI limit vs. AL-value for PC40EER25.5 gapped core (Typical)

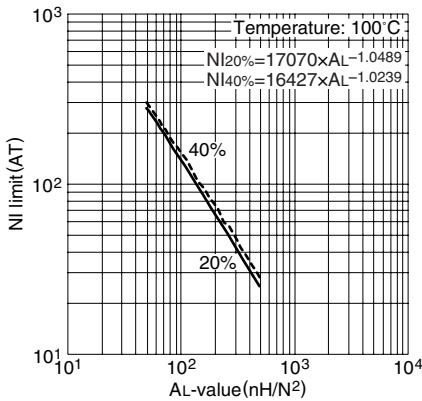

AL-value vs. Air gap length for PC40EER25.5 core (Typical)

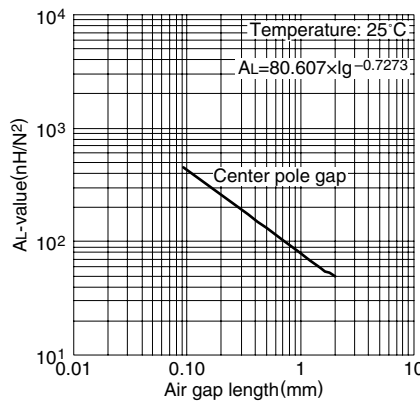

Temperature rise vs. Total loss for EER25.5 core (Typical) (Ambient temperature: 25°C)

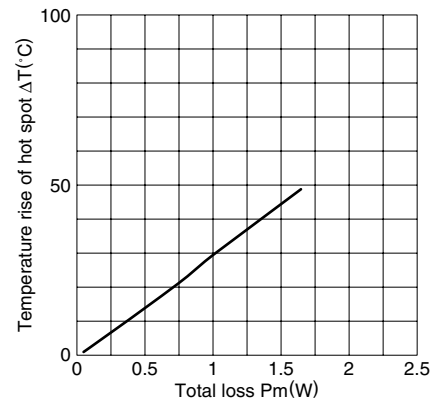

Note: The temperature rise is measured in the room whose temperature and humidity are fixed to 25°C and 45(%RH), respectively. (approx. 400×300×300cm)

NI limit vs. AL-value for PC95EER25.5 gapped core (Typical)

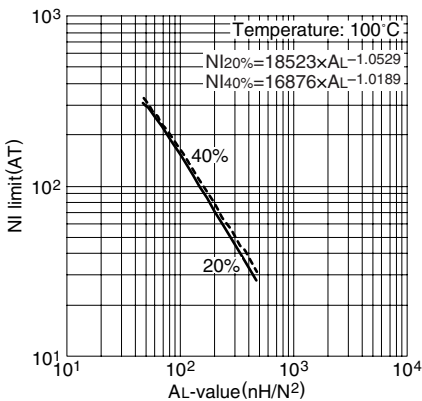

AL-value vs. Air gap length for PC95EER25.5 core (Typical)

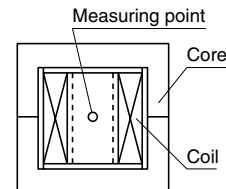
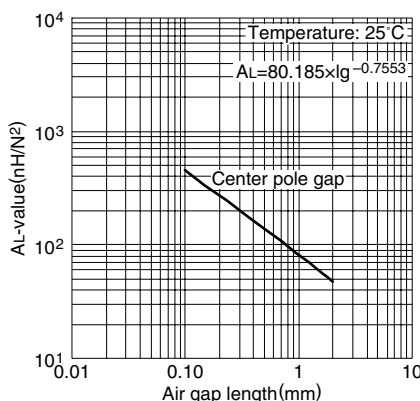

Note: NI limit shows the point where the exciting current is 20% and 40% away from its extended linear part.

Measuring conditions • Coil: ø0.35 2UEW 100Ts
 • Frequency: 1kHz
 • Level: 0.5mA

EER Series EER28 Cores(JIS FEER 28.5A)

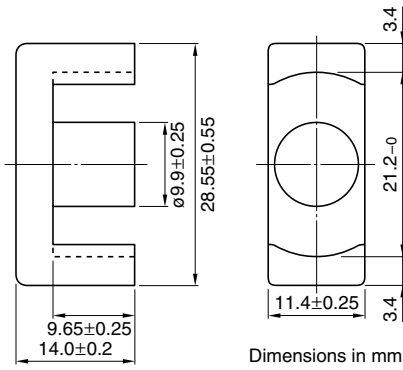

PARAMETER

Core factor	C1	mm ⁻¹	0.78
Effective magnetic path length	ℓ _e	mm	64.0
Effective cross-sectional area	A _e	mm ²	82.1
Effective core volume	V _e	mm ³	5250
Cross-sectional center pole area	A _{cp}	mm ²	77.0
Minimum cross-sectional center pole area	A _{cp min.}	mm ²	73.1
Cross-sectional winding area of core	A _{cw}	mm ²	114
Weight (approx.)		g	28

Part No.	AL-value (nH/N ²)	Core loss (W) 100kHz, 200mT	Calculated output power (forward converter mode)
PC40EER28-Z	2870±25% (1kHz, 0.5mA)* 4350 min. (100kHz, 200mT)	2.3 max.(100°C)	203W (100kHz)
PC95EER28-Z	2870±25% (1kHz, 0.5mA)* 4000±25%	2.45/2.1/2.45(25°C/80°C/120°C)	223W

* Coil: ø0.35 2UEW 100Ts

NI limit vs. AL-value for PC40EER28 gapped core (Typical)

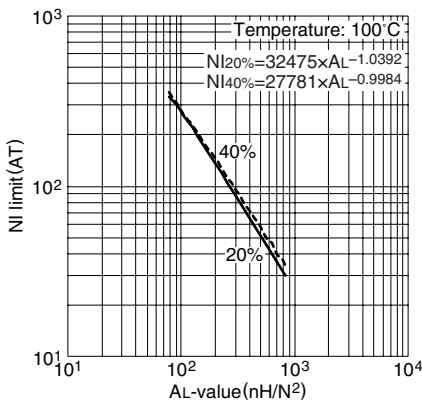

AL-value vs. Air gap length for PC40EER28 core (Typical)

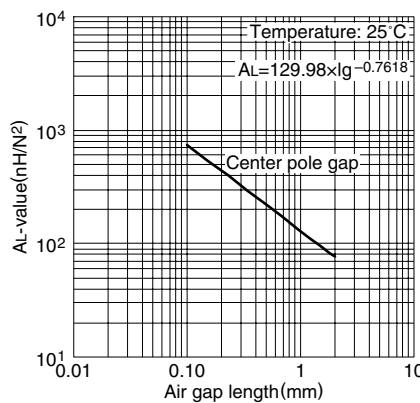

Temperature rise vs. Total loss for EER28 core (Typical) (Ambient temperature: 25°C)

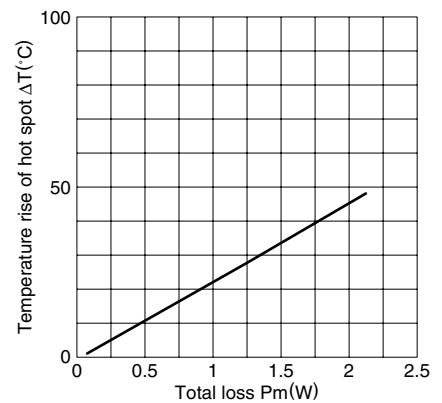

Note: The temperature rise is measured in the room whose temperature and humidity are fixed to 25°C and 45(%)RH, respectively. (approx. 400×300×300cm)

NI limit vs. AL-value for PC95EER28 gapped core (Typical)

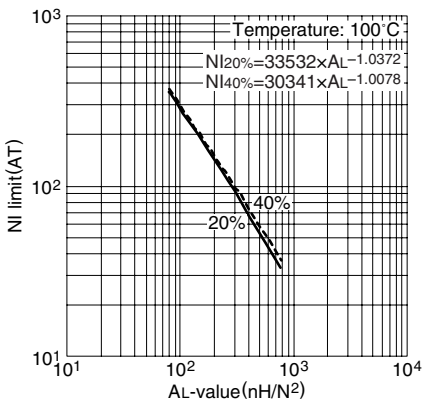

AL-value vs. Air gap length for PC95EER28 core (Typical)

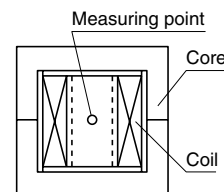
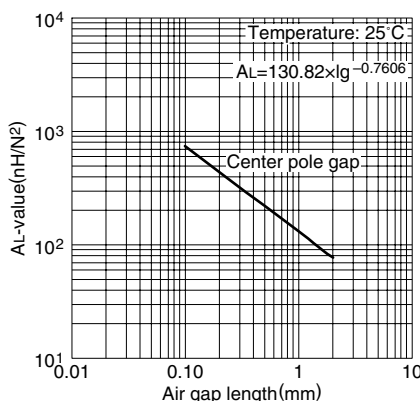

Note: NI limit shows the point where the exciting current is 20% and 40% away from its extended linear part.

Measuring conditions • Coil: ø0.35 2UEW 100Ts
• Frequency: 1kHz
• Level: 0.5mA

EER Series EER28L Cores(JIS FEER 28.5B)

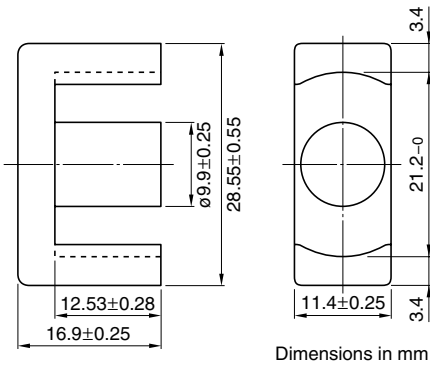

PARAMETER

Core factor	C1	mm ⁻¹	0.928
Effective magnetic path length	ℓ _e	mm	75.5
Effective cross-sectional area	A _e	mm ²	81.4
Effective core volume	V _e	mm ³	6150
Cross-sectional center pole area	A _{cp}	mm ²	77.0
Minimum cross-sectional center pole area	A _{cp min.}	mm ²	73.1
Cross-sectional winding area of core	A _{cw}	mm ²	148
Weight (approx.)		g	33

Part No.	AL-value (nH/N ²)	Core loss (W) 100kHz, 200mT	Calculated output power (forward converter mode)
PC40EER28L-Z	2520±25% (1kHz, 0.5mA)* 3660 min. (100kHz, 200mT)	2.7 max.(100°C)	228W (100kHz)
PC95EER28L-Z	2520±25% (1kHz, 0.5mA)* 3500±25%	2.9/2.45/2.9(25°C/80°C/120°C)	250W

* Coil: ø0.35 2UEW 100Ts

NI limit vs. AL-value for PC40EER28L gapped core (Typical)

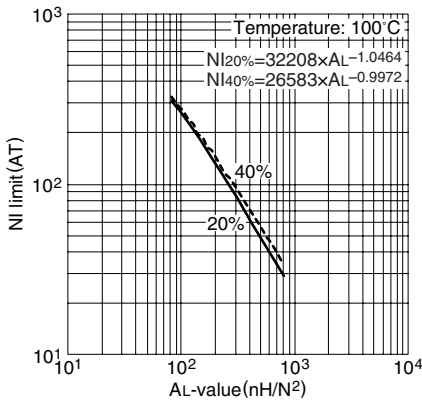

AL-value vs. Air gap length for PC40EER28L core (Typical)

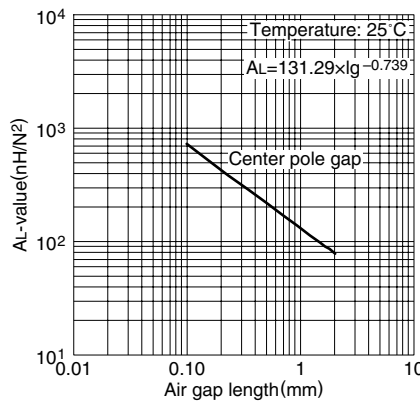

Temperature rise vs. Total loss for EER28L core (Typical) (Ambient temperature: 25°C)

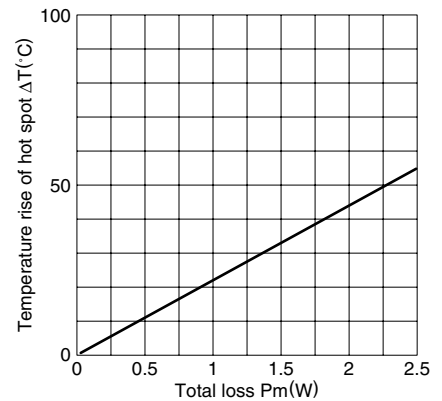

Note: The temperature rise is measured in the room whose temperature and humidity are fixed to 25°C and 45(%)RH, respectively. (approx. 400×300×300cm)

NI limit vs. AL-value for PC95EER28L gapped core (Typical)

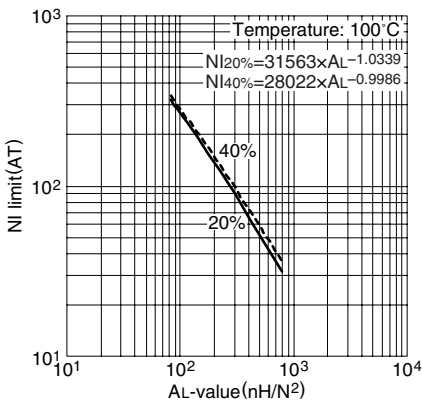

AL-value vs. Air gap length for PC95EER28L core (Typical)

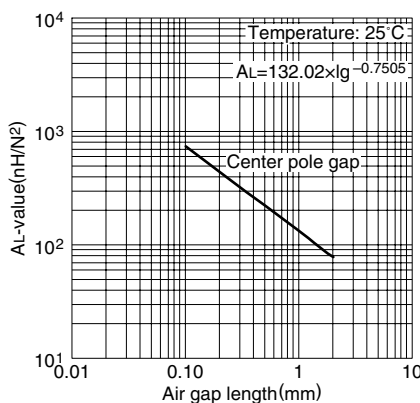

Note: NI limit shows the point where the exciting current is 20% and 40% away from its extended linear part.

Measuring conditions • Coil: ø0.35 2UEW 100Ts
• Frequency: 1kHz
• Level: 0.5mA

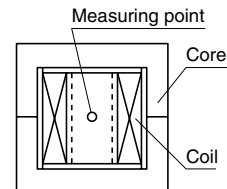

EER Series EER35 Cores(JIS FEER 35A)

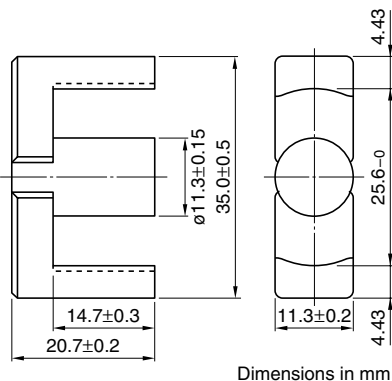

Dimensions in mm

PARAMETER

Core factor	C1	mm ⁻¹	0.849
Effective magnetic path length	ℓ _e	mm	90.8
Effective cross-sectional area	A _e	mm ²	107
Effective core volume	V _e	mm ³	9720
Cross-sectional center pole area	A _{cp}	mm ²	100
Minimum cross-sectional center pole area	A _{cp min.}	mm ²	97.6
Cross-sectional winding area of core	A _{cw}	mm ²	218
Weight (approx.)	g		52

Part No.	AL-value (nH/N ²)	Core loss (W) 100kHz, 200mT	Calculated output power (forward converter mode)
PC40EER35-Z	2770±25% (1kHz, 0.5mA)* 4000 min. (100kHz, 200mT)	4.2 max.(100°C)	325W (100kHz)
PC95EER35-Z	2770±25% (1kHz, 0.5mA)* 4000±25%	4.55/3.8/4.55(25°C/80°C/120°C)	336W

* Coil: ø0.35 2UEW 100Ts

NI limit vs. AL-value for PC40EER35 gapped core (Typical)

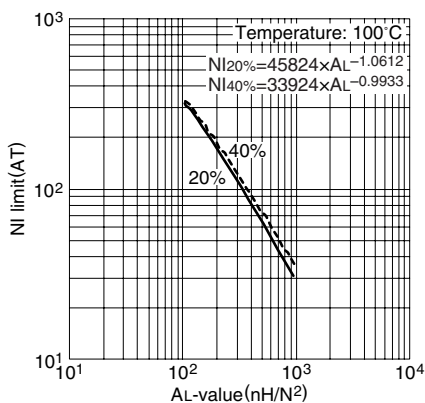

AL-value vs. Air gap length for PC40EER35 core (Typical)

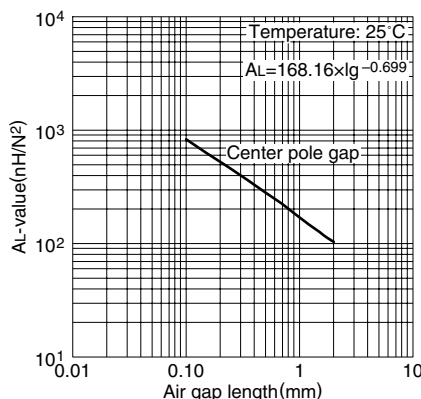

Temperature rise vs. Total loss for EER35 core (Typical) (Ambient temperature: 25°C)

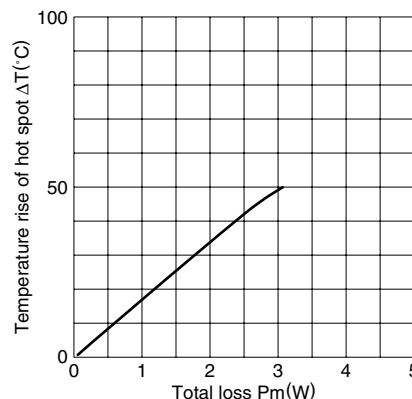

Note: The temperature rise is measured in the room whose temperature and humidity are fixed to 25°C and 45(%)RH, respectively. (approx. 400×300×300cm)

NI limit vs. AL-value for PC95EER35 gapped core (Typical)

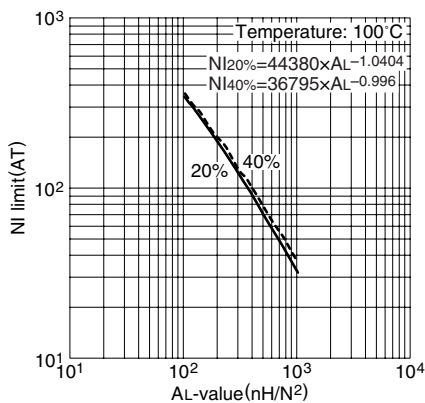

AL-value vs. Air gap length for PC95EER35 core (Typical)

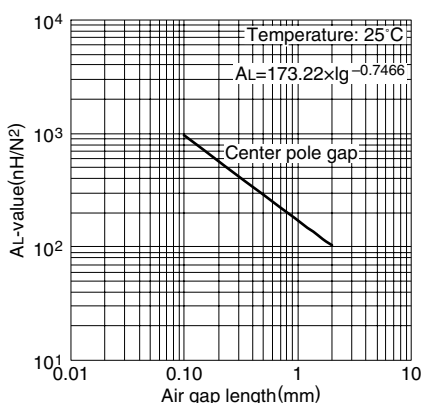

Note: NI limit shows the point where the exciting current is 20% and 40% away from its extended linear part.

Measuring conditions • Coil: ø0.35 2UEW 100Ts
• Frequency: 1kHz
• Level: 0.5mA

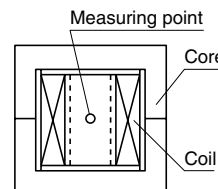

EER Series EER40 Cores

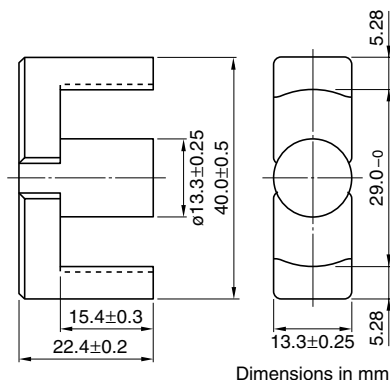

PARAMETER

Core factor	C1	mm ⁻¹	0.658
Effective magnetic path length	ℓ _e	mm	98.0
Effective cross-sectional area	A _e	mm ²	149
Effective core volume	V _e	mm ³	14600
Cross-sectional center pole area	A _{cp}	mm ²	139
Minimum cross-sectional center pole area	A _{cp min.}	mm ²	134
Cross-sectional winding area of core	A _{cw}	mm ²	249
Weight (approx.)	g		78

Part No.	AL-value (nH/N ²)	Core loss (W) 100kHz, 200mT	Calculated output power (forward converter mode)
PC40EER40-Z	3620±25% (1kHz, 0.5mA)* 5160 min. (100kHz, 200mT)	6.3 max.(100°C)	421W (100kHz)
PC95EER40-Z	3620±25% (1kHz, 0.5mA)* 5200±25%	6.8/5.7/6.8(25°C/80°C/120°C)	446W

* Coil: ø0.35 2UEW 100Ts

NI limit vs. AL-value for PC40EER40 gapped core (Typical)

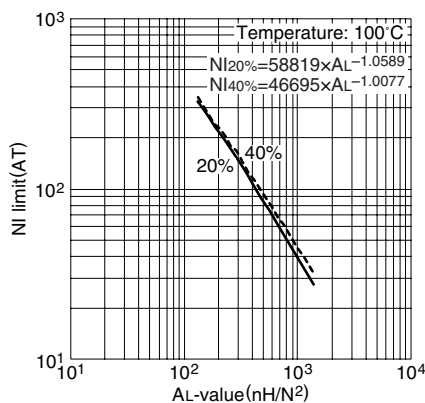

AL-value vs. Air gap length for PC40EER40 core (Typical)

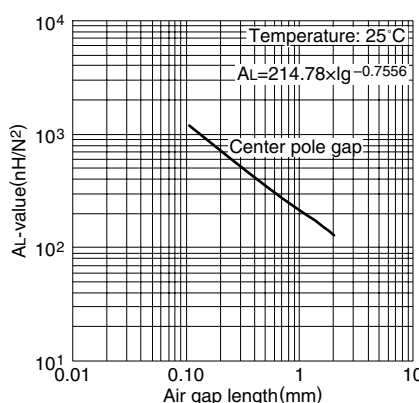

Temperature rise vs. Total loss for EER40 core (Typical) (Ambient temperature: 25°C)

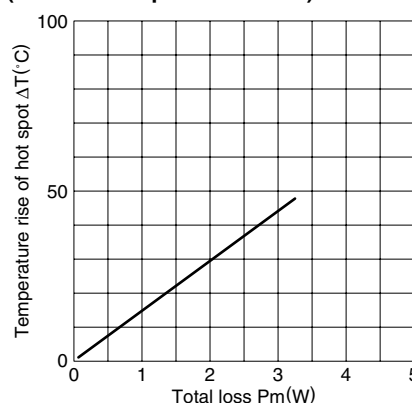

Note: The temperature rise is measured in the room whose temperature and humidity are fixed to 25°C and 45(%)RH, respectively. (approx. 400×300×300cm)

NI limit vs. AL-value for PC95EER40 gapped core (Typical)

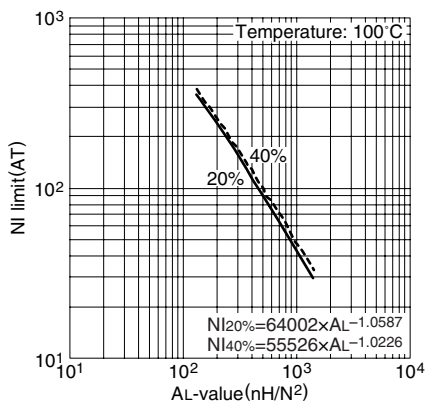

Note: NI limit shows the point where the exciting current is 20% and 40% away from its extended linear part.

AL-value vs. Air gap length for PC95EER40 core (Typical)

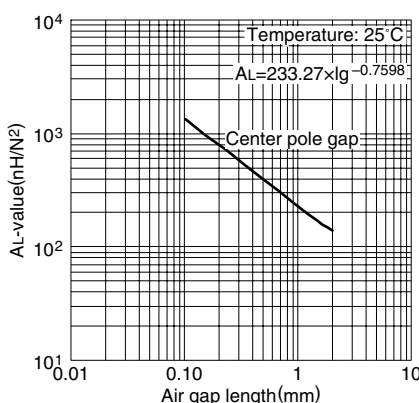

Measuring conditions • Coil: ø0.35 2UEW 100Ts
• Frequency: 1kHz
• Level: 0.5mA

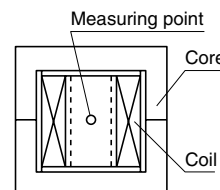

EER Series EER42 Cores(JIS FEER 42)

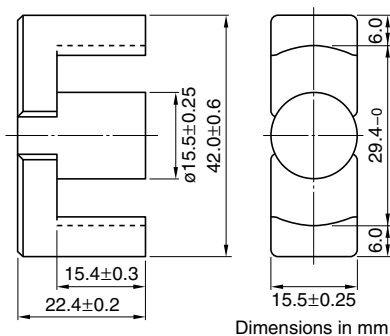

PARAMETER

Core factor	C1	mm ⁻¹	0.509
Effective magnetic path length	ℓ_e	mm	98.8
Effective cross-sectional area	A_e	mm ²	194
Effective core volume	V_e	mm ³	19200
Cross-sectional center pole area	A_{cp}	mm ²	187
Minimum cross-sectional center pole area	$A_{cp \text{ min.}}$	mm ²	183
Cross-sectional winding area of core	A_{cw}	mm ²	223
Weight (approx.)		g	102

Part No.	AL-value (nH/N ²)	Core loss (W) at 100°C 100kHz, 200mT	Calculated output power (forward converter mode)
PC40EER42-Z	4690±25% (1kHz, 0.5mA)* 6670 min. (100kHz, 200mT)	8.6 max.	433W (100kHz)

* Coil: ϕ 0.35 2UEW 100Ts

NI limit vs. AL-value for PC40EER42 gapped core (Typical)

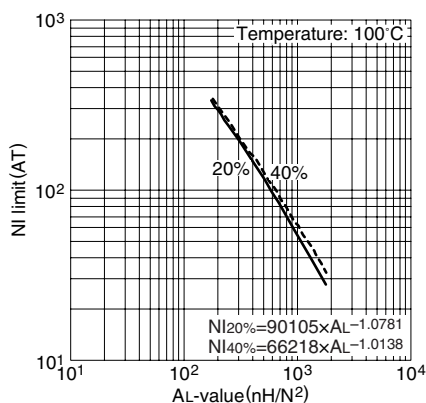

Note: NI limit shows the point where the exciting current is 20% and 40% away from its extended linear part.

AL-value vs. Air gap length for PC40EER42 core (Typical)

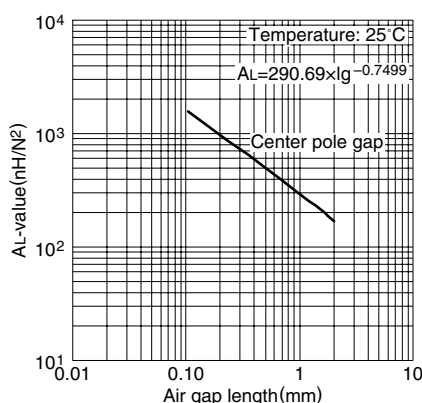

Measuring conditions • Coil: ϕ 0.35 2UEW 100Ts
 • Frequency: 1kHz
 • Level: 0.5mA

Temperature rise vs. Total loss for EER42 core (Typical) (Ambient temperature: 25°C)

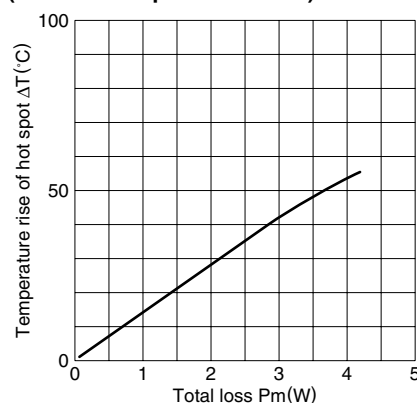

Note: The temperature rise is measured in the room whose temperature and humidity are fixed to 25°C and 45(%)RH, respectively. (approx. 400×300×300cm)

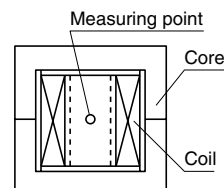

EER Series EER42/42/20 Cores

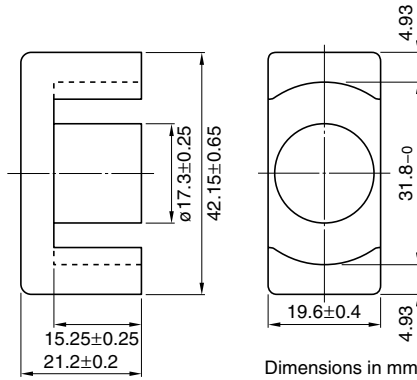

PARAMETER

Core factor	C1	mm ⁻¹	0.411
Effective magnetic path length	ℓ_e	mm	98.6
Effective cross-sectional area	A_e	mm ²	240
Effective core volume	V_e	mm ³	23700
Cross-sectional center pole area	A_{cp}	mm ²	235
Minimum cross-sectional center pole area	$A_{cp \text{ min.}}$	mm ²	228
Cross-sectional winding area of core	A_{cw}	mm ²	229
Weight (approx.)		g	116

Part No.	AL-value (nH/N ²)	Core loss (W) at 100°C 100kHz, 200mT	Calculated output power (forward converter mode)
PC40EER42/42/20-Z	5340±25% (1kHz, 0.5mA)* 8260 min. (100kHz, 200mT)	10.7 max.	509W (100kHz)

* Coil: ϕ 0.35 2UEW 100Ts

NI limit vs. AL-value for PC40EER42/42/20 gapped core (Typical)

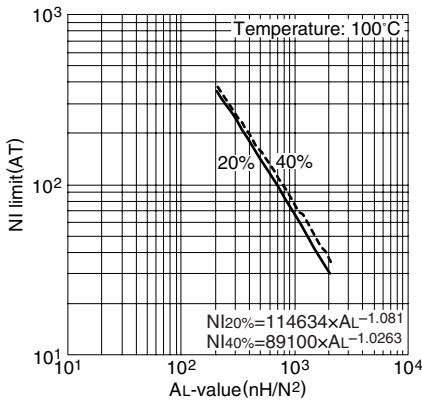

Note: NI limit shows the point where the exciting current is 20% and 40% away from its extended linear part.

AL-value vs. Air gap length for PC40EER42/42/20 core (Typical)

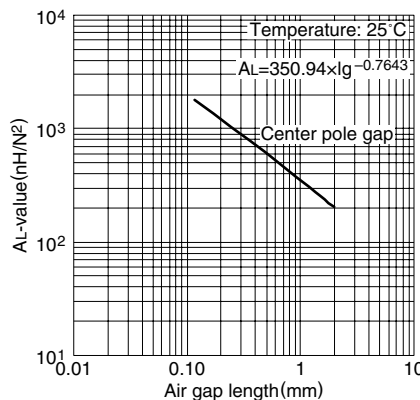

Measuring conditions

- Coil: ϕ 0.35 2UEW 100Ts
- Frequency: 1kHz
- Level: 0.5mA

Temperature rise vs. Total loss for EER42/42/20core (Typical) (Ambient temperature: 25°C)

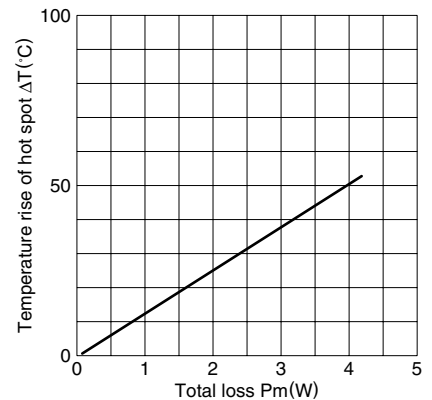

Note: The temperature rise is measured in the room whose temperature and humidity are fixed to 25°C and 45(%)RH, respectively. (approx. 400×300×300cm)

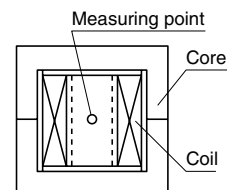

ETD Series ETD19 Cores

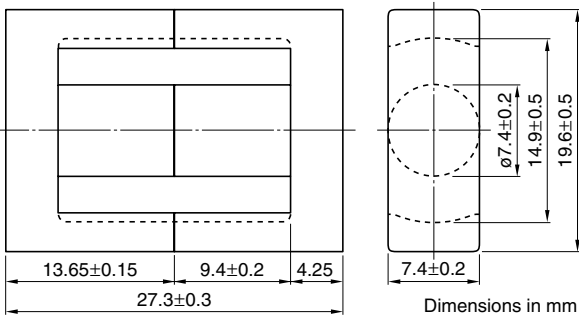

PARAMETER

Core factor	C1	mm ⁻¹	1.32
Effective magnetic path length	ℓ_e	mm	54.6
Effective cross-sectional area	A_e	mm ²	41.3
Effective core volume	V_e	mm ³	2260
Cross-sectional center pole area	A_{cp}	mm ²	43
Minimum cross-sectional center pole area	$A_{cp \text{ min.}}$	mm ²	40.7
Cross-sectional winding area of core	A_{cw}	mm ²	70.5
Weight (approx.)	g		13.3

Part No.	AL-value (nH/N ²)	Core loss (W) at 100°C 100kHz, 200mT	Calculated output power (forward converter mode)
PC40ETD19-Z	1720±25% (1kHz, 0.5mA)* 2380 min. (100kHz, 200mT)	1.1 max.	79W (100kHz)

* Coil: ø0.35 2UEW 100Ts

NI limit vs. AL-value for PC40ETD19 gapped core (Typical)

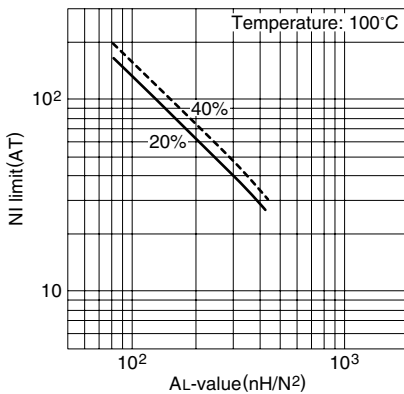

Note: NI limit shows the point where the exciting current is 20% and 40% away from its extended linear part.

AL-value vs. Air gap length for PC40ETD19 core (Typical)

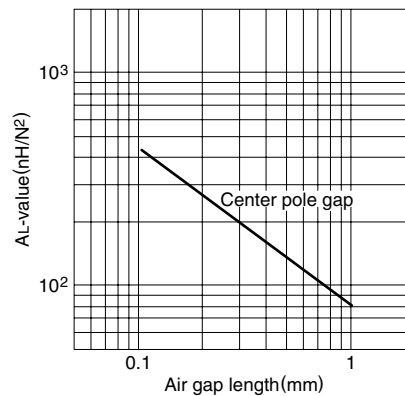

Measuring conditions • Coil: ø0.35 2UEW 100Ts
• Frequency: 1kHz
• Level: 0.5mA

Temperature rise vs. Total loss for ETD19 core (Typical)
(Ambient temperature: 25°C)

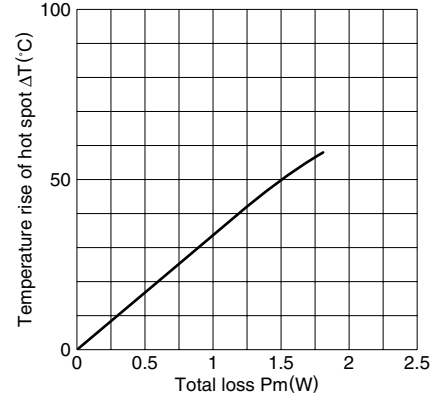

Note: The temperature rise is measured in the room whose temperature and humidity are fixed to 25°C and 45(%)RH, respectively. (approx. 400×300×300cm)

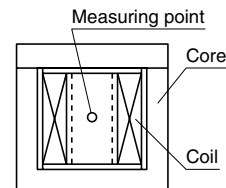

ETD Series ETD24 Cores

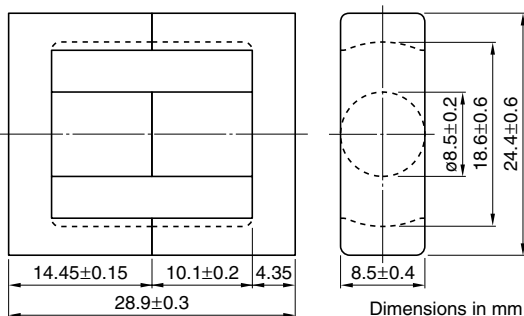

PARAMETER

Core factor	C1	mm ⁻¹	1.10
Effective magnetic path length	ℓ _e	mm	61.9
Effective cross-sectional area	A _e	mm ²	56.3
Effective core volume	V _e	mm ³	3480
Cross-sectional center pole area	A _{cp}	mm ²	56.7
Minimum cross-sectional center pole area	A _{cp min.}	mm ²	54.1
Cross-sectional winding area of core	A _{cw}	mm ²	102
Weight (approx.)		g	19.5

Part No.	AL-value (nH/N ²)	Core loss (W) at 100°C 100kHz, 200mT	Calculated output power (forward converter mode)
PC40ETD24-Z	2125±25% (1kHz, 0.5mA)* 2860 min. (100kHz, 200mT)	1.6 max.	115W (100kHz)

* Coil: ø0.35 2UEW 100Ts

NI limit vs. AL-value for PC40ETD24 gapped core (Typical)

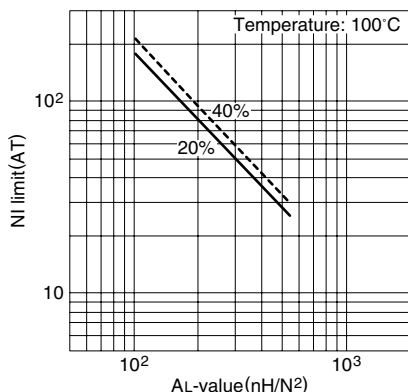

Note: NI limit shows the point where the exciting current is 20% and 40% away from its extended linear part.

AL-value vs. Air gap length for PC40ETD24 core (Typical)

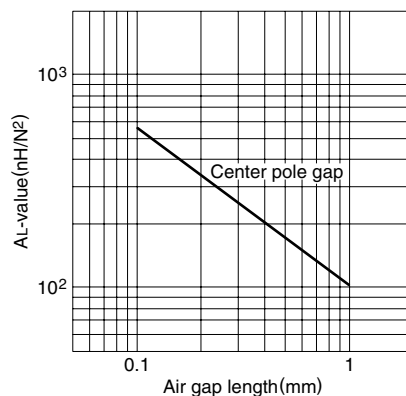

Measuring conditions • Coil: ø0.35 2UEW 100Ts
• Frequency: 1kHz
• Level: 0.5mA

Temperature rise vs. Total loss for ETD24 core (Typical)
(Ambient temperature: 25°C)

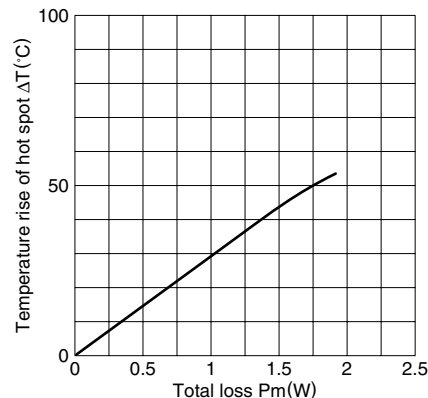

Note: The temperature rise is measured in the room whose temperature and humidity are fixed to 25°C and 45(%)RH, respectively. (approx. 400×300×300cm)

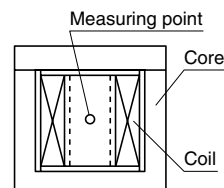

ETD Series ETD29 Cores

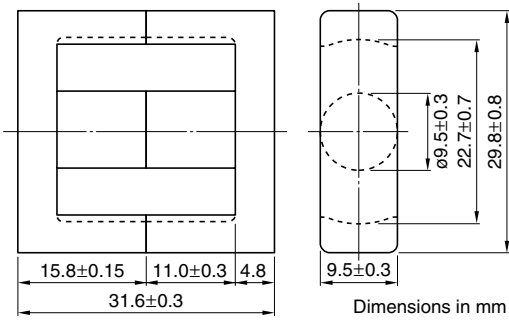

PARAMETER

Core factor	C1	mm ⁻¹	0.959
Effective magnetic path length	ℓ _e	mm	70.6
Effective cross-sectional area	A _e	mm ²	73.6
Effective core volume	V _e	mm ³	5200
Cross-sectional center pole area	A _{cp}	mm ²	70.9
Minimum cross-sectional center pole area	A _{cp min.}	mm ²	66.5
Cross-sectional winding area of core	A _{cw}	mm ²	145.2
Weight (approx.)		g	28

Part No.	AL-value (nH/N ²)	Core loss (W) at 100°C 100kHz, 200mT	Calculated output power (forward converter mode)
PC40ETD29-Z	2500±25% (1kHz, 0.5mA)* 3540 min. (100kHz, 200mT)	2.4 max.	170W (100kHz)

* Coil: ø0.35 2UEW 100Ts

NI limit vs. AL-value for PC40ETD29 gapped core (Typical)

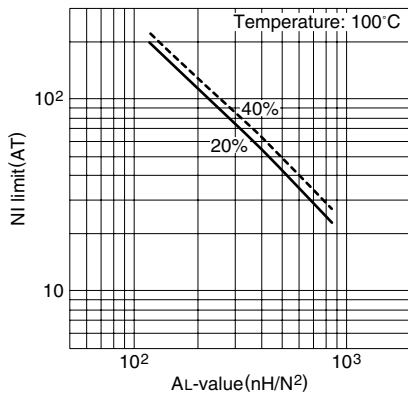

Note: NI limit shows the point where the exciting current is 20% and 40% away from its extended linear part.

AL-value vs. Air gap length for PC40ETD29 core (Typical)

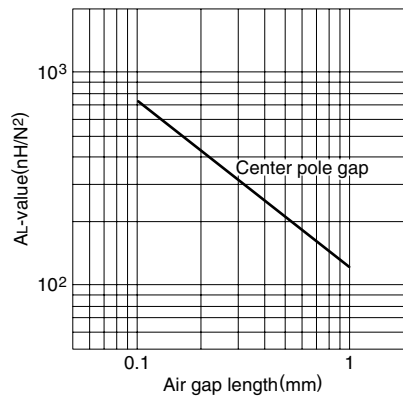

Measuring conditions • Coil: ø0.35 2UEW 100Ts
• Frequency: 1kHz
• Level: 0.5mA

**Temperature rise vs. Total loss for ETD29 core (Typical)
(Ambient temperature: 25°C)**

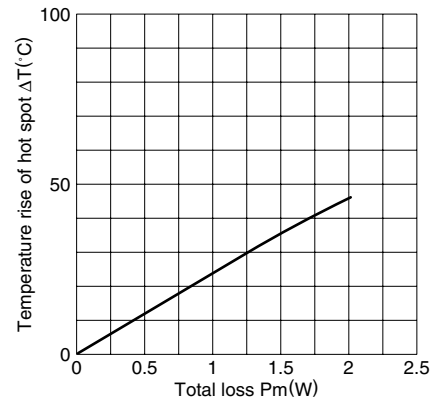

Note: The temperature rise is measured in the room whose temperature and humidity are fixed to 25°C and 45(%RH), respectively. (approx. 400×300×300cm)

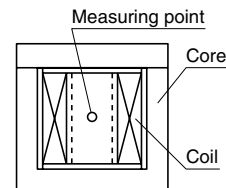

ETD Series ETD34 Cores

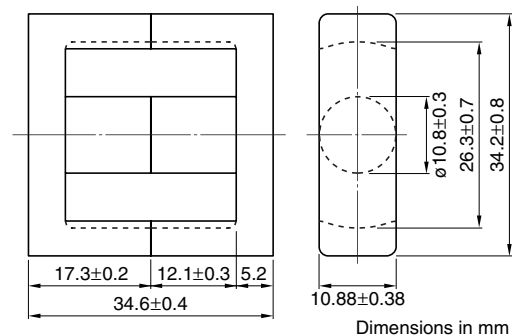

PARAMETER

Core factor	C1	mm ⁻¹	0.810
Effective magnetic path length	ℓ_e	mm	78.6
Effective cross-sectional area	A_e	mm ²	97.1
Effective core volume	V_e	mm ³	7630
Cross-sectional center pole area	A_{cp}	mm ²	91.6
Minimum cross-sectional center pole area	$A_{cp \text{ min.}}$	mm ²	86.6
Cross-sectional winding area of core	A_{cw}	mm ²	188
Weight (approx.)		g	40

Part No.	AL-value (nH/N ²)	Core loss (W) at 100°C 100kHz, 200mT	Calculated output power (forward converter mode)
PC40ETD34-Z	2780±25% (1kHz, 0.5mA)* 4190 min. (100kHz, 200mT)	3.31 max.	271W (100kHz)

* Coil: ϕ 0.35 2UEW 100Ts

NI limit vs. AL-value for PC40ETD34 gapped core (Typical)

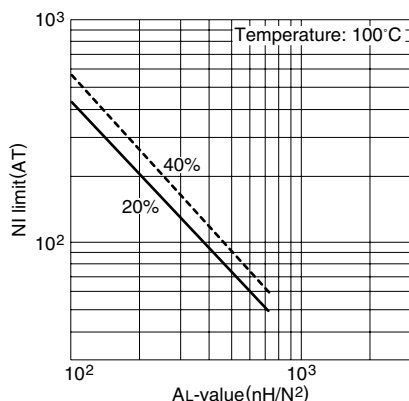

Note: NI limit shows the point where the exciting current is 20% and 40% away from its extended linear part.

AL-value vs. Air gap length for PC40ETD34 core (Typical)

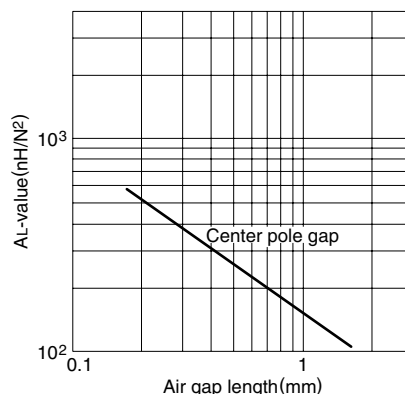

Measuring conditions

- Coil: ϕ 0.35 2UEW 100Ts
- Frequency: 1kHz
- Level: 0.5mA

Temperature rise vs. Total loss for ETD34 core (Typical) (Ambient temperature: 25°C)

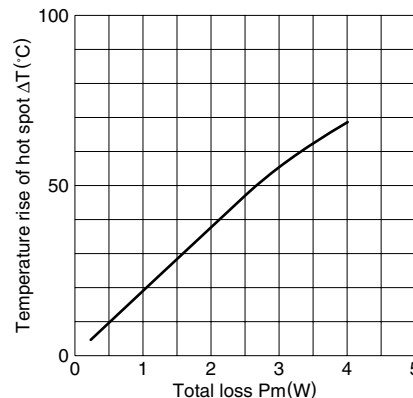

Note: The temperature rise is measured in the room whose temperature and humidity are fixed to 25°C and 45%RH, respectively. (approx. 400×300×300cm)

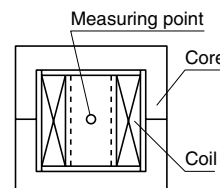

ETD Series ETD39 Cores

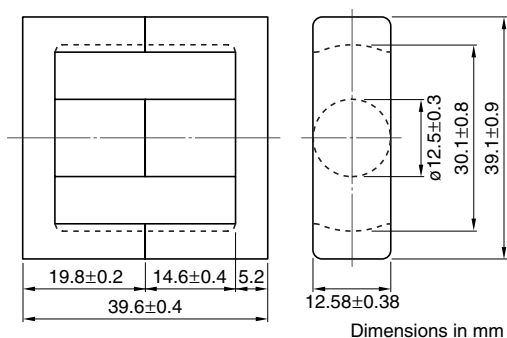

PARAMETER

Core factor	C1	mm ⁻¹	0.737
Effective magnetic path length	ℓ _e	mm	92.1
Effective cross-sectional area	A _e	mm ²	125
Effective core volume	V _e	mm ³	11500
Cross-sectional center pole area	A _{cp}	mm ²	123
Minimum cross-sectional center pole area	A _{cp min.}	mm ²	117
Cross-sectional winding area of core	A _{cw}	mm ²	257
Weight (approx.)		g	60

Part No.	AL-value (nH/N ²)	Core loss (W) at 100°C 100kHz, 200mT	Calculated output power (forward converter mode)
PC40ETD39-Z	3150±25% (1kHz, 0.5mA)* 4600 min. (100kHz, 200mT)	5.3 max.	382W (100kHz)

* Coil: ø0.35 2UEW 100Ts

NI limit vs. AL-value for PC40ETD39 gapped core (Typical)

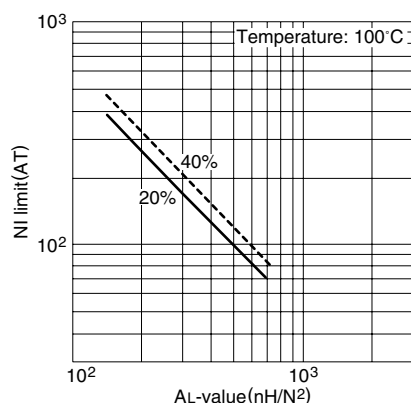

Note: NI limit shows the point where the exciting current is 20% and 40% away from its extended linear part.

AL-value vs. Air gap length for PC40ETD39 core (Typical)

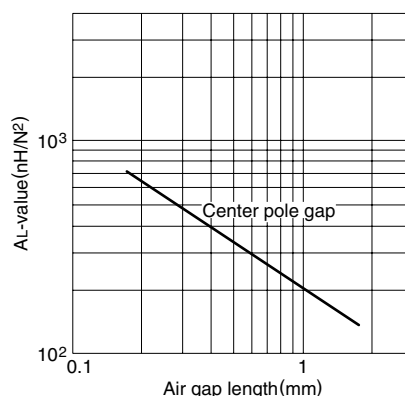

Measuring conditions • Coil: ø0.35 2UEW 100Ts
• Frequency: 1kHz
• Level: 0.5mA

Temperature rise vs. Total loss for ETD39 core (Typical) (Ambient temperature: 25°C)

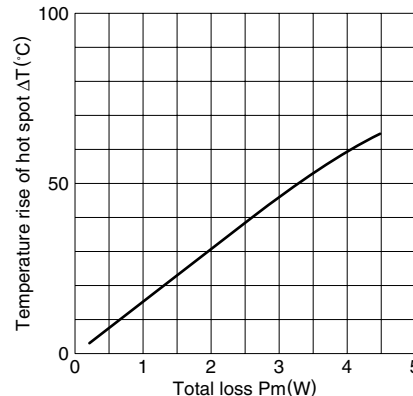

Note: The temperature rise is measured in the room whose temperature and humidity are fixed to 25°C and 45(%)RH, respectively. (approx. 400×300×300cm)

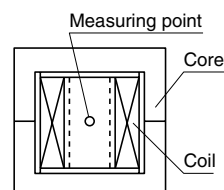

ETD Series ETD44 Cores

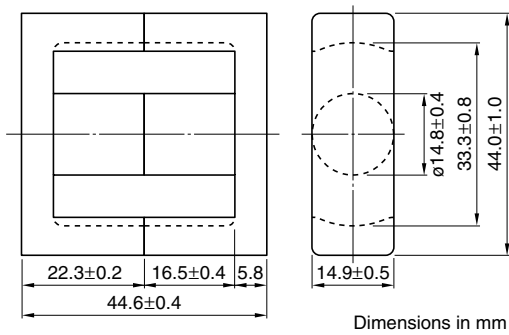

PARAMETER

Core factor	C1	mm ⁻¹	0.589
Effective magnetic path length	ℓ _e	mm	103
Effective cross-sectional area	A _e	mm ²	175
Effective core volume	V _e	mm ³	18000
Cross-sectional center pole area	A _{cp}	mm ²	172
Minimum cross-sectional center pole area	A _{cp min.}	mm ²	163
Cross-sectional winding area of core	A _{cw}	mm ²	305
Weight (approx.)		g	94

Part No.	AL-value (nH/N ²)	Core loss (W) at 100°C 100kHz, 200mT	Calculated output power (forward converter mode)
PC40ETD44-Z	4000±25% (1kHz, 0.5mA)* 5760 min. (100kHz, 200mT)	8.3 max.	523W (100kHz)

* Coil: ø0.35 2UEW 100Ts

NI limit vs. AL-value for PC40ETD44 gapped core (Typical)

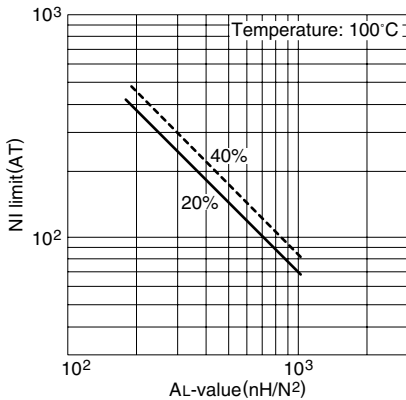

Note: NI limit shows the point where the exciting current is 20% and 40% away from its extended linear part.

AL-value vs. Air gap length for PC40ETD44 core (Typical)

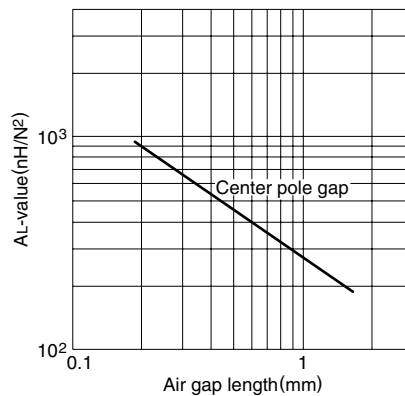

Measuring conditions

- Coil: ø0.35 2UEW 100Ts
- Frequency: 1kHz
- Level: 0.5mA

Temperature rise vs. Total loss for ETD44 core (Typical) (Ambient temperature: 25°C)

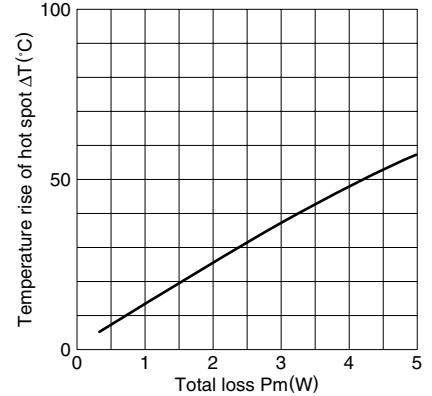

Note: The temperature rise is measured in the room whose temperature and humidity are fixed to 25°C and 45%RH, respectively. (approx. 400×300×300cm)

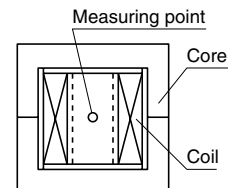

ETD Series ETD49 Cores

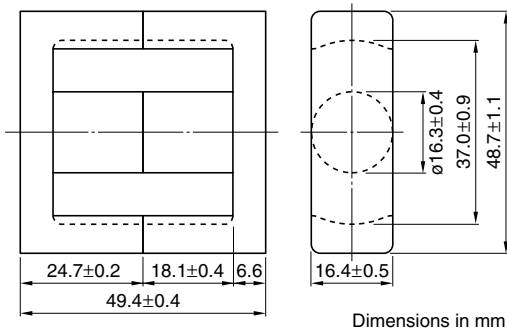

PARAMETER

Core factor	C1	mm ⁻¹	0.535
Effective magnetic path length	ℓ _e	mm	114
Effective cross-sectional area	A _e	mm ²	213
Effective core volume	V _e	mm ³	24300
Cross-sectional center pole area	A _{cp}	mm ²	209
Minimum cross-sectional center pole area	A _{cp min.}	mm ²	199
Cross-sectional winding area of core	A _{cw}	mm ²	375
Weight (approx.)		g	124

Part No.	AL-value (nH/N ²)	Core loss (W) at 100°C 100kHz, 200mT	Calculated output power (forward converter mode)
PC40ETD49-Z	4440±25% (1kHz, 0.5mA)* 6340 min. (100kHz, 200mT)	11.2 max.	682W (100kHz)

* Coil: ø0.35 2UEW 100Ts

NI limit vs. AL-value for PC40ETD49 gapped core (Typical)

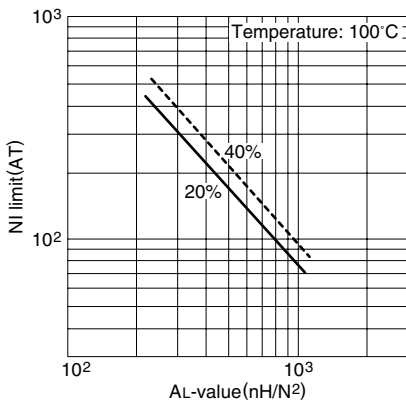

Note: NI limit shows the point where the exciting current is 20% and 40% away from its extended linear part.

AL-value vs. Air gap length for PC40ETD49 core (Typical)

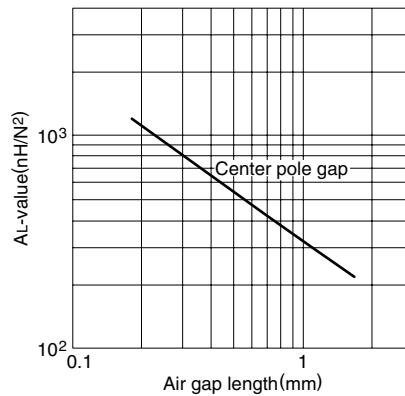

Measuring conditions • Coil: ø0.35 2UEW 100Ts
• Frequency: 1kHz
• Level: 0.5mA

Temperature rise vs. Total loss for ETD49 core (Typical) (Ambient temperature: 25°C)

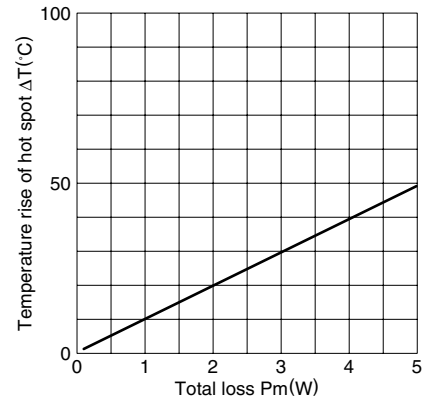

Note: The temperature rise is measured in the room whose temperature and humidity are fixed to 25°C and 45(%)RH, respectively. (approx. 400×300×300cm)

