

Silicon N Channel MOSFET Tetrode

BF 965

- Integrated suppression network against spurious VHF oscillations
- For VHF applications, especially in TV tuners with extended VHF band, e.g. CATV tuners

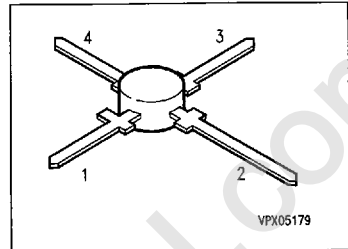

Type	Marking	Ordering Code	Pin Configuration				Package ¹⁾
			1	2	3	4	
BF 965	—	Q62702-F660	S	D	G ₂	G ₁	X-plast

Maximum Ratings

Parameter	Symbol	Values	Unit
Drain-source voltage	V_{DS}	20	V
Drain current	I_D	30	mA
Gate 1/gate 2 peak source current	$\pm I_{G1/2SM}$	10	
Total power dissipation, $T_A \leq 60^\circ\text{C}$	P_{tot}	200	mW
Storage temperature range	T_{stg}	- 55 ... + 150	°C
Channel temperature	T_{ch}	150	

Thermal Resistance

Junction - ambient	R_{thJA}	≤ 450	K/W
--------------------	------------	------------	-----

¹⁾ For detailed information see chapter Package Outlines.

Electrical Characteristicsat $T_A = 25\text{ }^\circ\text{C}$, unless otherwise specified.

Parameter	Symbol	Values			Unit
		min.	typ.	max.	

DC Characteristics

Drain-source breakdown voltage $I_D = 10\text{ }\mu\text{A}$, $-V_{G1S} = -V_{G2S} = 4\text{ V}$	$V_{(BR)DS}$	20	—	—	V
Gate 1 source breakdown voltage $\pm I_{G1S} = 10\text{ mA}$, $V_{G2S} = V_{DS} = 0$	$\pm V_{(BR)G1SS}$	8.5	—	14	
Gate 2 source breakdown voltage $\pm I_{G2S} = 10\text{ mA}$, $V_{G1S} = V_{DS} = 0$	$\pm V_{(BR)G2SS}$	8.5	—	14	
Gate 1 source leakage current $\pm V_{G1S} = 5\text{ V}$, $V_{G2S} = V_{DS} = 0$	$\pm I_{G1SS}$	—	—	50	nA
Gate 2 source leakage current $\pm V_{G2S} = 5\text{ V}$, $V_{G1S} = V_{DS} = 0$	$\pm I_{G2SS}$	—	—	50	
Drain current $V_{DS} = 15\text{ V}$, $V_{G1S} = 0$, $V_{G2S} = 4\text{ V}$	I_{DSS}	2	—	20	mA
Gate 1 source pinch-off voltage $V_{DS} = 15\text{ V}$, $V_{G2S} = 4\text{ V}$, $I_D = 20\text{ }\mu\text{A}$	$-V_{G1S(p)}$	—	—	2.5	V
Gate 2 source pinch-off voltage $V_{DS} = 15\text{ V}$, $V_{G1S} = 0$, $I_D = 20\text{ }\mu\text{A}$	$-V_{G2S(p)}$	—	—	2.0	

Electrical Characteristicsat $T_A = 25\text{ }^\circ\text{C}$, unless otherwise specified.

Parameter	Symbol	Values			Unit
		min.	typ.	max.	

AC Characteristics

Forward transconductance $V_{DS} = 15\text{ V}$, $I_D = 10\text{ mA}$, $V_{G2S} = 4\text{ V}$, $f = 1\text{ kHz}$	g_{fs}	15	18	–	mS
Gate 1 input capacitance $V_{DS} = 15\text{ V}$, $I_D = 10\text{ mA}$, $V_{G2S} = 4\text{ V}$, $f = 1\text{ MHz}$	C_{g1ss}	–	2.5	–	pF
Gate 2 input capacitance $V_{DS} = 15\text{ V}$, $I_D = 10\text{ mA}$, $V_{G2S} = 4\text{ V}$, $f = 1\text{ MHz}$	C_{g2ss}	–	1.2	–	
Feedback capacitance $V_{DS} = 15\text{ V}$, $I_D = 10\text{ mA}$, $V_{G2S} = 4\text{ V}$, $f = 1\text{ MHz}$	C_{dg1}	–	25	–	fF
Output capacitance $V_{DS} = 15\text{ V}$, $I_D = 10\text{ mA}$, $V_{G2S} = 4\text{ V}$, $f = 1\text{ MHz}$	C_{dss}	–	1	–	pF
Power gain $V_{DS} = 15\text{ V}$, $I_D = 10\text{ mA}$, $f = 200\text{ MHz}$, $G_G = 2\text{ mS}$, $G_L = 0.5\text{ mS}$ (test circuit)	G_{ps}	–	25	–	dB
Noise figure $V_{DS} = 15\text{ V}$, $I_D = 10\text{ mA}$, $f = 200\text{ MHz}$, $G_G = 2\text{ mS}$, $G_L = 0.5\text{ mS}$ (test circuit)	F	–	1	–	
Gain control range $V_{DS} = 15\text{ V}$, $V_{G2S} = 4 \dots -2\text{ V}$, $f = 200\text{ MHz}$ (test circuit)	ΔG_{ps}	50	–	–	

Total power dissipation $P_{tot} = f(T_A)$

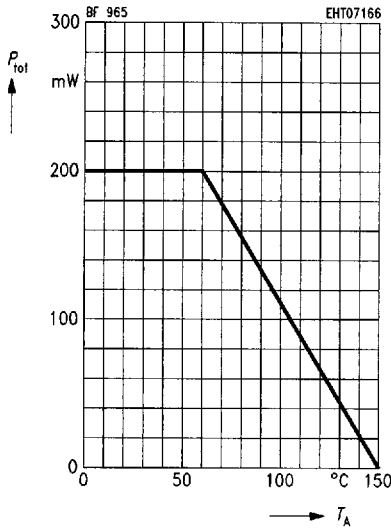

Output characteristics $I_D = f(V_{DS})$
 $V_{GS} = 4 \text{ V}$

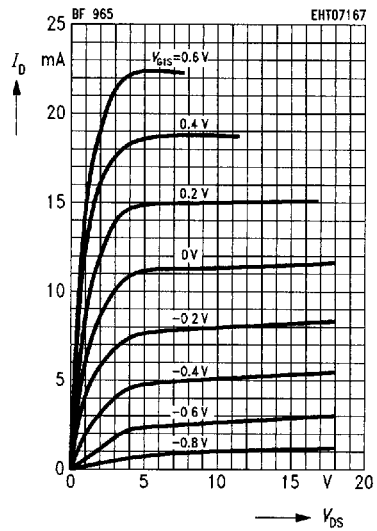

Gate 1 forward transconductance

$g_{fs1} = f(V_{GS1})$
 $V_{DS} = 15 \text{ V}$
 $I_{DSS} = 10 \text{ mA}, f = 1 \text{ kHz}$

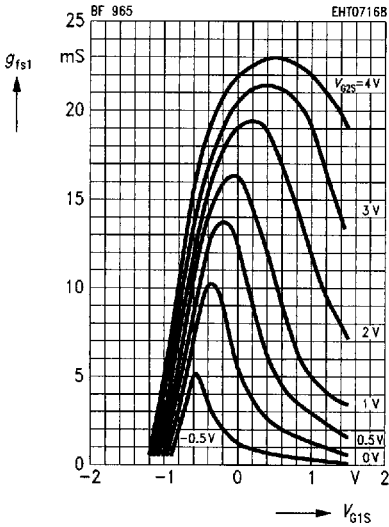

Gate 1 forward transconductance

$g_{fs1} = f(V_{GS2})$
 $V_{DS} = 15 \text{ V}$
 $I_{DSS} = 10 \text{ mA}, f = 1 \text{ kHz}$

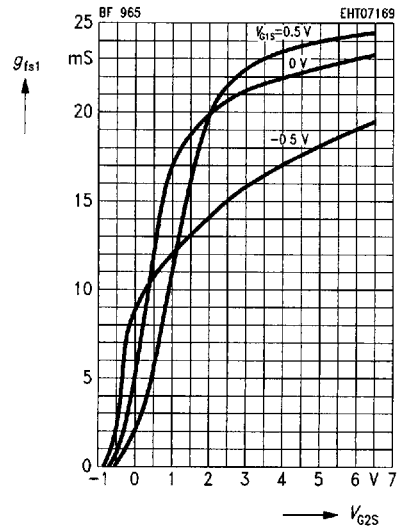

Drain current $I_D = f(V_{G1S})$

$V_{DS} = 15 \text{ V}$

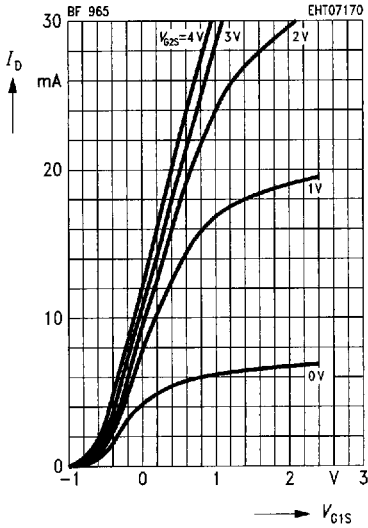

Gate 1 input capacitance $C_{g1ss} = f(V_{G1S})$

$V_{G2S} = 4 \text{ V}$, $V_{DS} = 15 \text{ V}$

$I_{DSS} = 10 \text{ mA}$, $f = 1 \text{ MHz}$

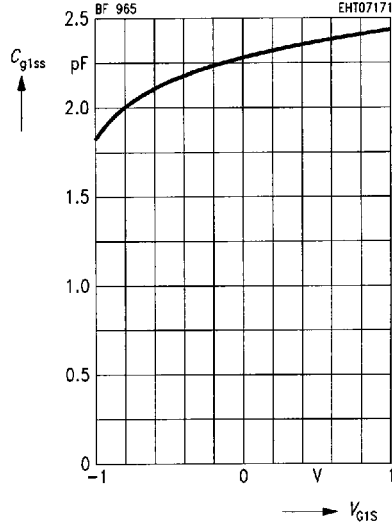

Gate 2 input capacitance $C_{g2ss} = f(V_{G2S})$

$V_{G1S} = 0 \text{ V}$, $V_{DS} = 15 \text{ V}$

$I_{DSS} = 10 \text{ mA}$, $f = 1 \text{ MHz}$

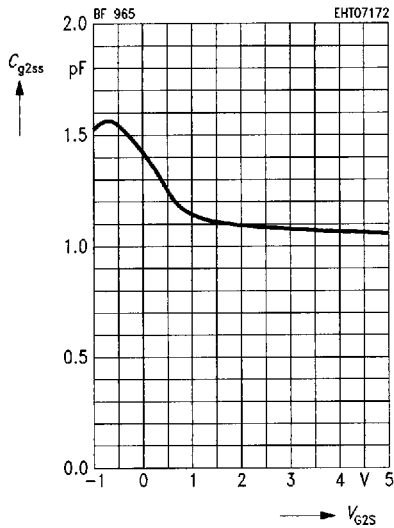

Output capacitance $C_{dss} = f(V_{DS})$

$V_{G1S} = 0 \text{ V}$, $V_{G2S} = 4 \text{ V}$

$I_{DSS} = 10 \text{ mA}$, $f = 1 \text{ MHz}$

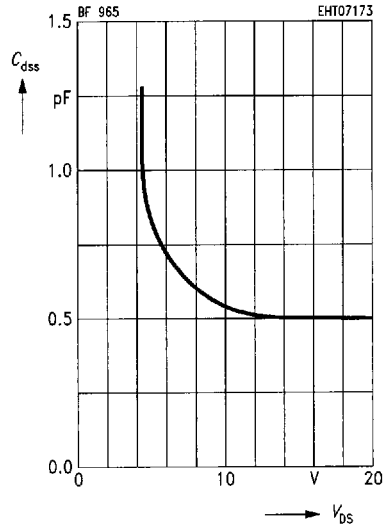

Gate 1 input admittance y_{11s}
 $V_{DS} = 15 \text{ V}$, $V_{G2S} = 4 \text{ V}$, $V_{G1S} = 0 \text{ V}$
 $I_{DSS} = 10 \text{ mA}$ (common source)

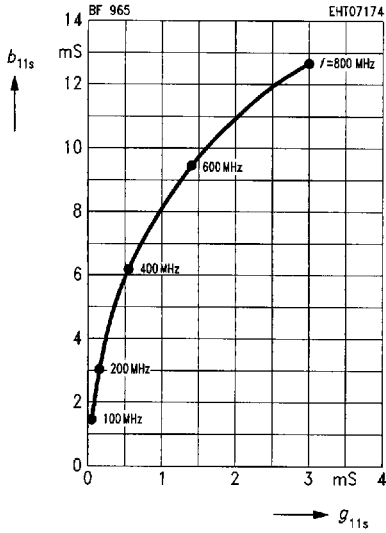

Gate 1 forward transfer admittance y_{21s}
 $V_{DS} = 15 \text{ V}$, $V_{G2S} = 4 \text{ V}$, $V_{G1S} = 0 \text{ V}$
 $I_{DSS} = 10 \text{ mA}$ (common source)

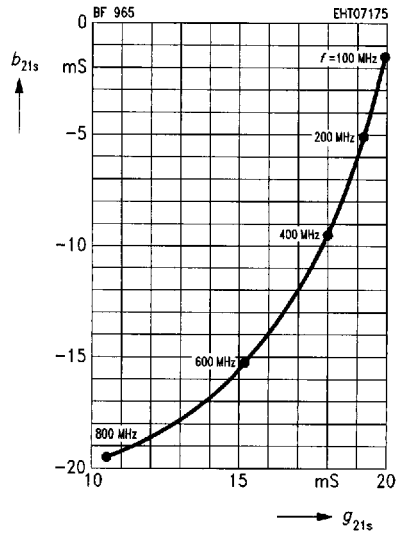

Output admittance y_{22s}
 $V_{DS} = 15 \text{ V}$, $V_{G2S} = 4 \text{ V}$, $V_{G1S} = 0 \text{ V}$
 $I_{DSS} = 10 \text{ mA}$ (common source)

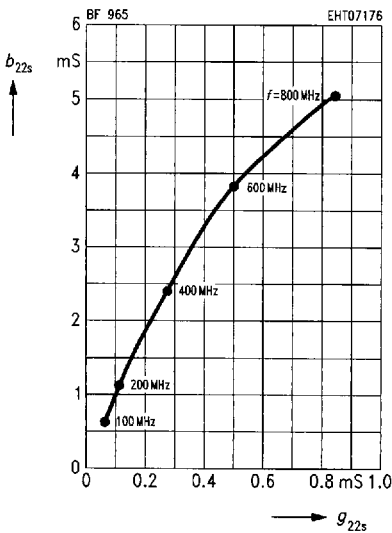

Power gain $G_{ps} = f(V_{G2S})$

$V_{DS} = 15 \text{ V}$, $V_{G1S} = 0 \text{ V}$, $I_{DSS} = 10 \text{ mA}$
 $f = 200 \text{ MHz}$ (see test circuit)

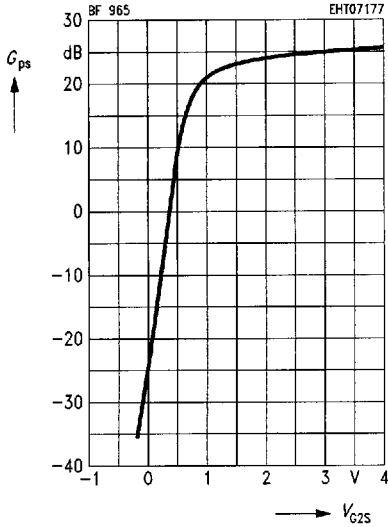

Noise figure $F = f(V_{G2S})$

$V_{DS} = 15 \text{ V}$, $V_{G1S} = 0 \text{ V}$, $I_{DSS} = 10 \text{ mA}$
 $f = 200 \text{ MHz}$ (see test circuit)

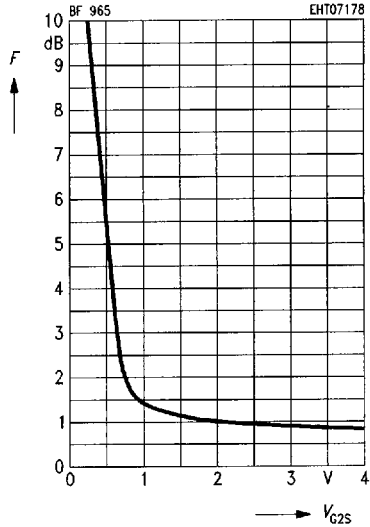

Test circuit for power gain and noise figure

$f = 200 \text{ MHz}$, $G_G = 2 \text{ mS}$, $G_L = 0.5 \text{ mS}$

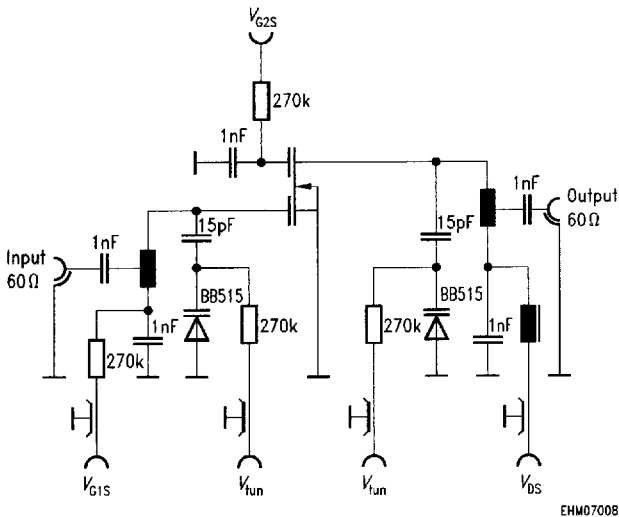

EHM07008