

## High Performance Digital FM Transmitter for Portable Devices

### General Description

The QN8027 is a high performance, low power, full-featured single-chip stereo FM transmitter designed for portable audio/video players, automotive accessories, cell phones, and GPS personal navigation devices. The QN8027 covers frequencies from 76 MHz to 108 MHz in 50/100/200 kHz step sizes for worldwide FM band support. The QN8027 also supports RDS/RBDS data transmit.

The QN8027 integrates a complete transmitter function, from stereo audio input to RF antenna port, for worldwide FM band personal area broadcasting. It includes variable input gain programming, selectable pre-emphasis, precision low-spur MPX stereo encoding and pilot tone generation, low-noise PLL-based modulation, and an on-chip power amplifier with variable output level and RF band-pass filtering to ensure optimum transmit spectrum purity.

An integrated crystal oscillator and on-chip digital calibration circuits eliminate external tuning components and enable tuning-free manufacturing. Support for 12/24MHz reference clocks allows the chip to use readily available system clocks. Integrated saturation detection and a programmable audio interface eliminate distortion, optimize audio fidelity, and support a wide range of input audio levels. A low power IDLE mode extends battery life. An integrated LDO enables direct connection to the battery and provides high PSRR for superior noise suppression, in particular TDMA noise from GSM/GPRS phones.

The QN8027's small footprint, high integration with minimum external component count, and support for 12/24MHz clock frequencies make it easy to integrate into a variety of small form-factor low-power portable applications. Integrated low-phase noise digital synthesizers and extensive on-chip auto calibration ensures robust consistent performance over temperature and process variations. An integrated voltage regulator enables direct connection to a battery and provides high PSRR for superior noise suppression. A low-power IDLE mode extends battery life.

ESD protection is on all pins. The QN8027 is fabricated in highly reliable CMOS technology.

### Key Features

- **Worldwide FM Band Transmit**
  - 76 MHz to 108 MHz full band tuning in 50/100/200 kHz step sizes
  - 50/75 $\mu$ s pre-emphasis
- **Ease of Integration**
  - Small footprint, 3 x 3 x 0.95mm MSOP10
  - Only 2 external passive components required
  - Adaptive antenna tuning
  - Low cellular and GPS band spurs
  - High Immunity to TDMA (GSM/GPRS) burst noise
  - Multiple crystal frequencies supported
  - I<sup>2</sup>C interface
- **Very Low Power Consumption**
  - 6.5 mA of FCC output level
  - Integrated voltage regulator, direct connect to battery
  - Power saving IDLE-mode
- **High Performance FM Transmitter (FMT)**
  - 63dB Stereo SNR, 0.05% THD
  - Maximum 121 dBuVp RF output level with 42dB adjustable range
- **Automatic Input Audio Sensing**
  - RF power automatically turned off if no input audio signal for 60s
- **RDS/RBDS Transmit**
  - Supports US and European data service, including TMC (Traffic Messaging Channel)
- **Robust Operation**
  - -25<sup>o</sup>C to +85<sup>o</sup>C operation
  - ESD protection on all input and output pads

### Typical Applications

- Cell Phones / PDAs / Smart Phones
- Portable Audio & Media Players
- GPS Personal Navigation Devices
- Automotive and Accessories

**CONTENTS**

1 Functional Block Diagram ..... 4

2 Pin Assignments..... 5

3 Electrical Specifications ..... 6

4 Functional Description ..... 11

    4.1 Transmit Mode..... 11

    4.2 Idle Mode..... 11

    4.3 Audio Interface ..... 11

    4.4 Audio Processing ..... 11

    4.5 Channel Setting..... 12

    4.6 RDS/RBDS ..... 12

5 Control Interface Protocol ..... 13

    5.1 I<sup>2</sup>C Serial Control Interface..... 13

6 User Control Registers..... 15

7 Package Description ..... 25

8 Solder Reflow Profile ..... 28

    8.1 Package Peak Reflow Temperature ..... 28

    8.2 Classification Reflow Profiles ..... 28

    8.3 Maximum Reflow Times ..... 29

Confidential  
Internal Use Only

## REVISION HISTORY

REVISION	CHANGE DESCRIPTION	DATE
0.1	Datasheet draft.	12/08/08
0.21	Check the grammar and syntax, Update the data ,the key features, and user control registers, Delete the Section 4.6 Audio Encryption for Privacy , Modify the Vcc value ;modify the pin FMO back RFO;	02/23/09
0.22	Modify Table 6: match the notes with the parameters; add “at maximal power”	03/18/09
0.23	Add Ordering Information	03/19/09
0.24	Modify Figure 11: save to slave; and I <sup>2</sup> C slave address	03/27/09
0.25	Modify register 07h [2:0] and the description of the register 10h [6:0] about PA	04/08/09
0.26	<ol style="list-style-type: none"> <li>1. Add section 4.7 Power Setting;</li> <li>2. Modify reg 00h Bit 7: wo → r/w;</li> <li>3. Delete reg 02h [7]: ‘and de-emphasis’;</li> <li>4. Modify reg 03h [7:6]: internal oscillator → crystal: [5:0] add ‘when use crystal on XTAL1/XTAL2’.</li> <li>5. Modify reg 11h:FEDV → FDEV</li> <li>6. Modify reg 12h [7] No RDS →RDS disable;</li> </ol>	04/08/09

### STATEMENT:

Users are responsible for compliance with local regulatory requirements for low power unlicensed FM broadcast operation. Quintic is not responsible for any violations resulting from user’s intentional or unintentional breach of regulatory requirements in personal or commercial use.

# 1 FUNCTIONAL BLOCK DIAGRAM

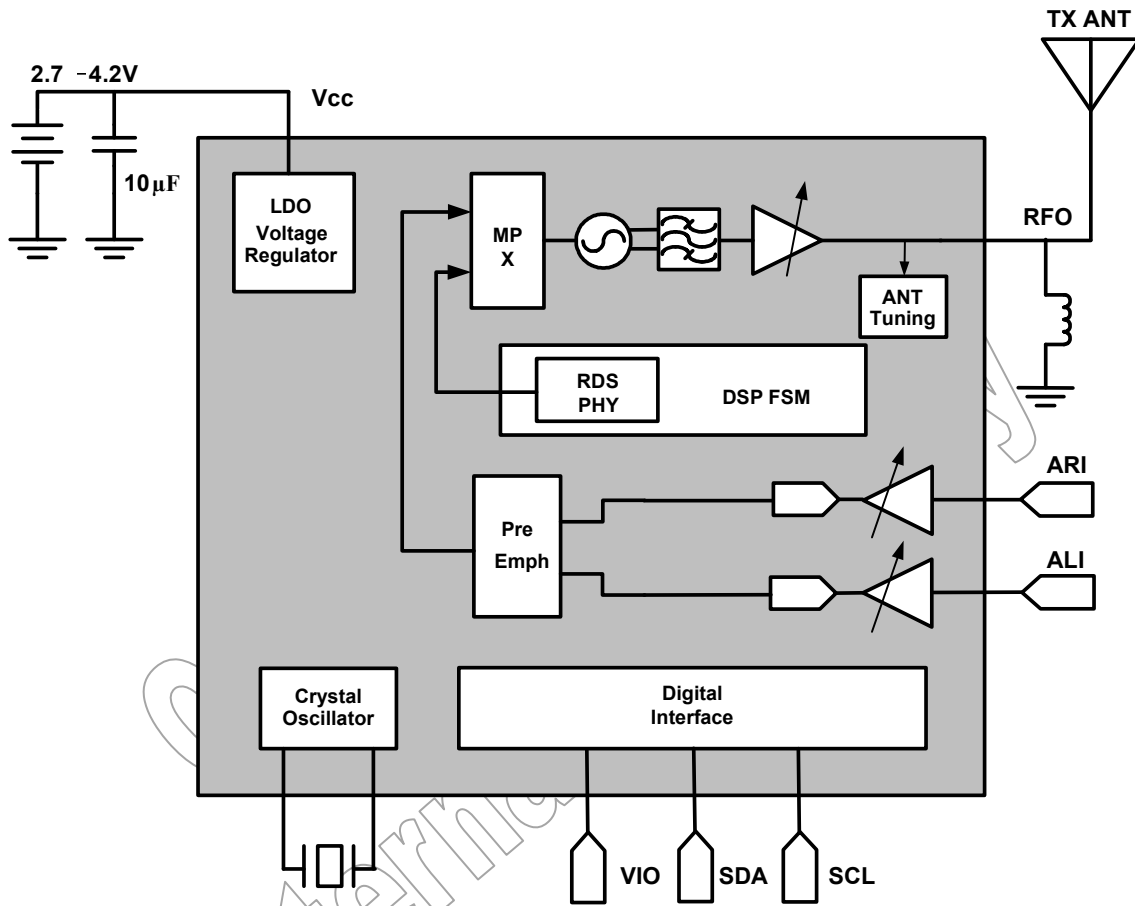

**Figure 1: QN8027-SANB Functional Blocks**

## 2 PIN ASSIGNMENTS

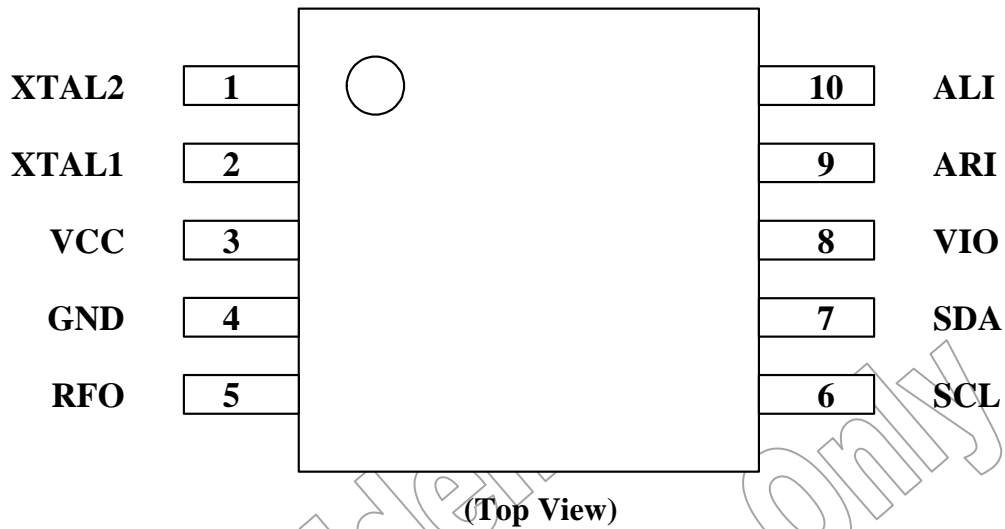

**Figure 2: QN8027 Device Pin Out**

**Table 1: Pin Descriptions**

PINS	NAME	DESCRIPTION
1	XTAL2	On-chip crystal driver port 2. If using an external clock source, connect this pin to ground.
2	XTAL1	On-chip crystal driver port 1. If using an external clock source, connect this pin to inject the clock.
3	VCC	Voltage supply
4	GND	Ground
5	RFO	Transmitter RF output – connect to matched antenna.
6	SCL	Clock for I <sup>2</sup> C serial bus.
7	SDA	Bi-directional data line for I <sup>2</sup> C serial bus.
8	VIO	IO voltage – specifies voltage limit for all digital pins.
9	ARI	Analog audio input – right channel
10	ALI	Analog audio input – left channel

### 3 ELECTRICAL SPECIFICATIONS

**Table 2: Absolute Maximum Ratings**

SYMBOL	PARAMETER	CONDITIONS	MIN	MAX	UNIT
V <sub>bat</sub>	Supply voltage	VCC to GND	-0.3	5	V
V <sub>IO</sub>	Logic signals	SCL, SDA to GND	-0.3	3.6	V
T <sub>s</sub>	Storage temperature		-55	+150	°C

**Table 3: Recommended Operating Conditions**

SYMBOL	PARAMETER	CONDITIONS	MIN	TYP	MAX	UNIT
V <sub>cc</sub>	Supply voltage	VCC to GND	2.7	3.3	4.2	V
T <sub>A</sub>	Operating temperature		-25		+85	°C
V <sub>ain</sub>	L/R channel input signal level	Single ended peak to peak voltage		1000	1400	mV
V <sub>IO</sub>	Digital I/O voltage		1.6		3.6	V

**Table 4: DC Characteristics**

(V<sub>CC</sub> = 2.7 ~ 4.2 V, T<sub>A</sub> = -25 ~ 85 °C, unless otherwise noticed. Typical values are at V<sub>CC</sub> = 3.3V and T<sub>A</sub> = 25°C).

SYMBOL	PARAMETER	CONDITIONS	MIN	TYP	MAX	UNIT
I <sub>TX</sub>	Transmit mode supply current		6.5	7.0 <sup>1</sup>	9.9	mA
I <sub>IDLE</sub>	Idle mode supply current	Idle mode		1.2		mA
<b>Interface</b>						
V <sub>OH</sub>	High level output voltage		0.9*V <sub>IO</sub>			V
V <sub>OL</sub>	Low level output voltage				0.1*V <sub>IO</sub>	V
V <sub>IH</sub>	High level input voltage		0.7*V <sub>IO</sub>			V
V <sub>IL</sub>	Low level input voltage				0.4	V
Notes: 1. RFO output at FCC level.						

**Table 5: AC Characteristics**

(V<sub>CC</sub> = 2.7 ~ 4.2 V, T<sub>A</sub> = -25 ~ 85 °C, unless otherwise noticed. Typical values are at V<sub>CC</sub> = 3.3V and T<sub>A</sub> = 25°C).

SYMBOL	PARAMETERS	CONDITIONS	MIN	TYP	MAX	UNIT
F <sub>xtal</sub>	Crystal or Clock frequency		12 or 24			MHz
F <sub>xtal_err</sub>	Crystal frequency accuracy	Over temperature, and aging	-20		20	ppm
Notes: 1. See also XSEL, R04[7].						

**Table 6: Transmitter Characteristics**

(Vcc = 2.7 ~ 4.2 V, T<sub>A</sub> = -25 ~ 85 °C, unless otherwise noticed. Typical values are at Vcc = 3.3V and T<sub>A</sub> = 25°C).

SYMBOL	PARAMETERS	CONDITIONS	MIN	TYP	MAX	UNIT
R <sub>audio_in</sub>	Audio input impedance	At pin ALI and ARI	5		40	kΩ
C <sub>audio_in</sub>	Audio input capacitance <sup>1</sup>	At pin ALI and ARI		2	5	pF
G <sub>audio_In</sub>	Audio input gain	RIN[1:0] = 10	-9		6	dB
ΔG <sub>audio_In</sub>	Audio gain step	For any gain setting	0.5	1	1.5	dB
τ <sub>emph</sub>	Pre-emphasis time constant <sup>1</sup>	PETC = 1	71.3	75	78.7	μs
		PETC = 0	47.5	50	52.5	
SNR <sub>audio_tx</sub>	Tx audio SNR <sup>2</sup>	MONO, Δf = 22.5 kHz		TBD		dB
		STEREO, Δf = 67.5 kHz, Δf <sub>pilot</sub> = 6.75 kHz		63		
THD <sub>audio_tx</sub>	Tx audio THD <sup>2</sup>	STEREO, Δf = 67.5 kHz, Δf <sub>pilot</sub> = 6.75 kHz		0.03	0.1	%
α <sub>L,R_tx</sub>	L/R separation <sup>2</sup>		35	42		dB
B <sub>L,R_tx</sub>	L/R channel imbalance <sup>1</sup>	L and R channel gain imbalance at 1 kHz offset from DC			1	dB
M <sub>pilot</sub>	19 kHz pilot modulation <sup>2,5</sup>	Relative to 75 kHz deviation	7	9.0	15	%
SUP <sub>sub</sub>	38 kHz sub-carrier <sup>2</sup> suppression		40			dB
C <sub>tune</sub>	Output capacitance tuning range		5		30	pF
P <sub>out</sub>	RF output voltage swing <sup>3</sup>	RF Channel frequency = 88 MHz	82		121	dBμV
ΔG <sub>RF_Out</sub>	Power gain step	Over process, temperature		0.75		dB
ΔP <sub>out</sub>	Power gain flatness	Over 76 MHz ~ 108 MHz	-2		TBD	dB
P <sub>mask</sub>	RF output spectrum mask <sup>4</sup>	120 kHz to 240 kHz offset		TBD	TBD	dBc
		240 kHz to 600 kHz offset		TBD	TBD	
		>600 kHz offset			TBD	
F <sub>rf</sub>	RF channel frequency		76		108	MHz
F <sub>ch</sub>	Channel frequency step		50	100	200	kHz
F <sub>err</sub>	Channel center frequency accuracy		-2		2	kHz
F <sub>perr</sub>	Pilot Tone frequency accuracy <sup>1</sup>		-2		2	Hz
F <sub>pk</sub>	Modulation peak frequency deviation	STEREO		75		kHz



SYMBOL	PARAMETERS	CONDITIONS	MIN	TYP	MAX	UNIT
Notes:						
<ol style="list-style-type: none"> <li>Guaranteed by design.</li> <li>1000mVp-p, 1 kHz tone at ALI pin, no input signal at ARI pin.</li> <li>Into matched antenna (see application note for details).</li> <li>Within operating band 76 MHz to 108 MHz.</li> <li>Value set with GAIN_TXPLT[3:0] (reg. 02h, bits 3:0). The user must conform to local regulatory requirements for low-power unlicensed FM broadcast operation when setting this value.</li> </ol>						

**Table 7: Timing Characteristics**

(Vcc = 2.7 ~ 4.2 V, TA = -25 ~ 85 °C, unless otherwise noticed. Typical values are at Vcc = 3.3V and TA = 25°C).

SYMBOL	PARAMETER	CONDITIONS	MIN	TYP	MAX	UNIT
$\tau_{pup}$	Chip power-up time <sup>1</sup>	From rising edge of Power-On to PLL settled and transmitter ready for transmission.			TBD	Sec
$\tau_{chsw}$	Channel switching time <sup>1</sup>	From any channel to any channel.			TBD	Sec
Notes:						
<ol style="list-style-type: none"> <li>Guaranteed by design.</li> </ol>						

**Table 8: I<sup>2</sup>C Interface Timing Characteristics**

(V<sub>cc</sub> = 2.7 ~ 4.2 V, T<sub>A</sub> = -25 ~ 85 °C, unless otherwise noticed. Typical values are at V<sub>cc</sub> = 3.3V and T<sub>A</sub> = 25°C).

SYMBOL	PARAMETER	CONDITIONS	MIN	TYP	MAX	UNIT
f <sub>SCL</sub>	I <sup>2</sup> C clock frequency				400	kHz
t <sub>LOW</sub>	Clock Low time		1.3			μs
t <sub>HI</sub>	Clock High time		0.8			μs
t <sub>ST</sub>	SCL input to SDA falling edge start <sup>1,3</sup>		0.6			μs
t <sub>STHD</sub>	SDA falling edge to SCL falling edge start <sup>3</sup>		0.6			μs
t <sub>rc</sub>	SCL rising edge <sup>3</sup>	Level from 30% to 70%			300	ns
t <sub>fc</sub>	SCL falling edge <sup>3</sup>	Level from 70% to 30%			300	ns
t <sub>dtHD</sub>	SCL falling edge to next SDA rising edge <sup>3</sup>		TBD			ns
t <sub>dtc</sub>	SDA rising edge to next SCL rising edge <sup>3</sup>				900	ns
t <sub>stp</sub>	SCL rising edge to SDA rising edge <sup>2,3</sup>		0.6			μs
t <sub>w</sub>	Duration before restart <sup>3</sup>		1.3			μs
C <sub>b</sub>	SCL, SDA capacitive loading <sup>3</sup>			10		pF

Notes:

1. Start signaling of I<sup>2</sup>C interface.
2. Stop signaling of I<sup>2</sup>C interface.
3. Guaranteed by design.

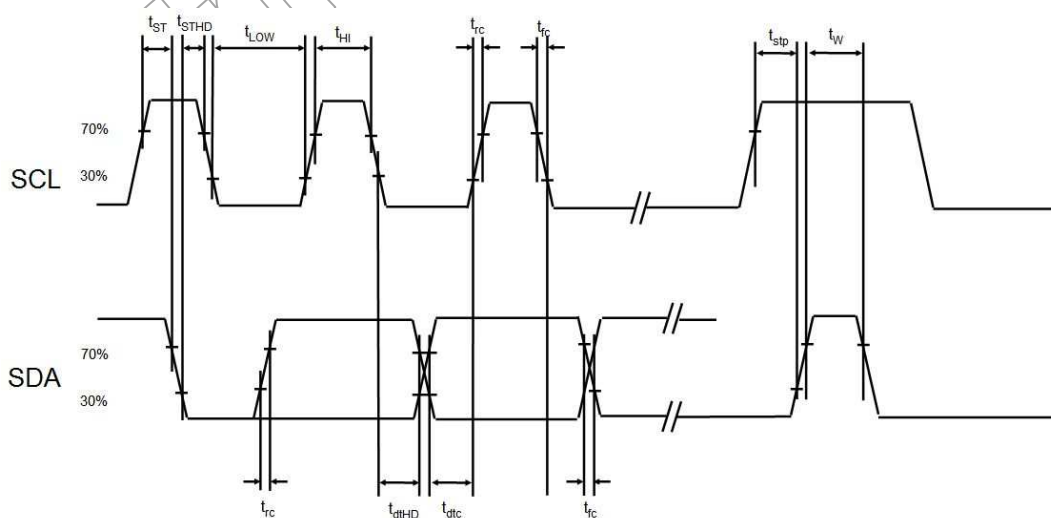

**Figure 3: I<sup>2</sup>C Serial Control Interface Timing Diagram**

## 4 FUNCTIONAL DESCRIPTION

The QN8027 is a high performance low power single chip FM transmitter IC that supports worldwide FM broadcast band operation. It has an IDLE mode for saving power. RDS/RBDS data service is also supported.

### 4.1 Transmit Mode

The QN8027 transmitter uses a highly digitized architecture. The input left and right analog audio signals are first adjusted by VGA, and then digitized by two high resolution ADCs into the digital domain. Pre-emphasis and MPX encoding are then performed. If RDS mode is enabled, the RDS signal will also be mixed with the MPX signal and the combined output will be fed into a high performance digital FM modulator which generates FM signal at RF carrier frequency. The FM signal is then filtered and amplified by the PA.

The QN8027 can deliver up to 121dB $\mu$ V output signal to an external antenna and/or matching network. An RF VGA provides a 42dB output power control range in 0.75 dB steps and can be programmed through the serial control bus. Output power control and in-band power flatness can be easily achieved by a calibration circuit. This wide range of control allow for various antenna configurations such as loop, monopole, or meandering traces on PCB. An integrated RF bandpass filter ensures optimal output spectrum purity.

### 4.2 Idle Mode

The QN8027 features a low power IDLE mode for fast turn around and power savings. After power up, the QN8027 will enter IDLE mode automatically.

### 4.3 Audio Interface

The QN8027 has a highly flexible analog audio interface. For audio input, the signal is AC coupled with 3dB corner frequency less than 50Hz. It has 4 different input impedances and 15dB adjustable gain range. Digital gain provides more accurate gain control (in 1dB steps) to optimize the SNR and linearity. The gain setting can be manually set through the serial interface.

### 4.4 Audio Processing

The QN8027 supports audio AGC, programmable pre-emphasis. When there is no audio signal for a pre-determined period, AGC will power down the transmitter. A peak detector is also integrated to measure the input audio level. User can program VGA based on the peak value.

Stereo signal is generated by the MPX circuit. It combines the left and right channel signals in the following way:

$$m(t) = [L(t) + R(t)] + [L(t) - R(t)]\cos(4\pi ft + 2\theta_0) + \alpha \cos(2\pi ft + \theta_0) + d(t)\cos(6\pi ft + 3\theta_0)$$

Here, L(t) and R(t) correspond to the audio signals on left and right channels respectively,  $f = 19$  kHz,  $\theta$  is the initial phase of pilot tone and  $\alpha$  is the magnitude of pilot tone, and d(t) is RDS signal. In mono mode, only the L+R portion of audio signal is transmitted. The 19 kHz pilot tone is generated by the MPX circuit which contributes 9% of peak modulation, and RDS signal will contribute 2.1% of peak modulation.

A pre-emphasis function is also integrated with both 75 $\mu$ s and 50 $\mu$ s time constants. The time constant can be programmed through the serial control interface.

## 4.5 Channel Setting

By programming channel index CH[9:0], the RF channel can be set to any frequency between 76 MHz ~ 108 MHz in 50 kHz steps. The channel index and RF frequency have the following relationship:

$$F_{RF} = (76 + 0.05 \times \text{Channel Index}), \text{ where } F_{RF} \text{ is the RF frequency in MHz.}$$

The QN8027 has an integrated crystal oscillator and supports 12/24M Hz crystals. Alternatively, the QN8027 can be driven externally by clock source.

## 4.6 RDS/RBDS

The QN8027 supports RDS/RBDS data transmitting, including station ID, Meta data, TMC information, etc. RDS/RBDS data communicates with an external MCU through the serial control interface.

## 4.7 Power Setting

Reg 10H[6:0] 'PPA\_TRGT' is used for PA output power control.

The PA output power expression of the PA output power is:

$$\text{Power} = (0.62 \times \text{PA}_{\text{TRGT}} + 71) \text{ dBuV}$$

And the PA\_TRRG T range is 20~75.

PA output power setting will not efficient immediately, it need to enter IDLE mode and re-enter TX mode, or when the frequency changed the PA output power setting will take effect.

## 5 CONTROL INTERFACE PROTOCOL

The QN8027 supports an I<sup>2</sup>C serial interface. At power-on, all register bits are set to default values.

### 5.1 I<sup>2</sup>C Serial Control Interface

The QN8027 uses the Phillips I<sup>2</sup>C standard in the I<sup>2</sup>C serial interface.

The I<sup>2</sup>C (L2) bus is a simple bi-directional bus interface. The bus requires only serial data (SDA) and serial clock (SCL) signals. The bus is 8-bit oriented. Each device is recognized with a unique address. Each register is also recognized with a unique address. The L2 bus operates with a maximum frequency of 400 kHz. Each data put on the SDA must be 8 bits long (Byte) from MSB to LSB and each byte sent should be acknowledged by an “ACK” bit. In case a byte is not acknowledged, the transmitter should generate a stop condition or restart the transmission. If a stop condition is created before the whole transmission is completed, the remaining bytes will keep their old setting. In case a byte is not completely transferred, it will be discarded.

Data transfer to and from the QN8027 can begin when a start condition is created. This is the case if a transition from HIGH to LOW on the SDA line occurs while the SCL is HIGH. The first byte transferred represents the address of the IC plus the data direction. The default IC address is 0x2C. A LOW LSB of this byte indicates data transmission (WRITE) while a HIGH LSB indicates data request (READ). This means that the first byte to be transmitted to the QN8027 should be “0x58” for a WRITE operation or “0x59” for a READ operation.

The second byte is the starting register address (N) for write/read operation. The following bytes are register data for address N, N+1, N+2, etc. There is no limit on the number of bytes in each transmission. A transmission can be terminated by generating a stop condition, which is SDA transition from LOW to HIGH while SCL is HIGH. For write operation, master stops transmission after the last byte. For read operation, master doesn't send ACK after receiving the last read back byte; then stops the transmission.

The timing diagrams below illustrate both write and read operations.

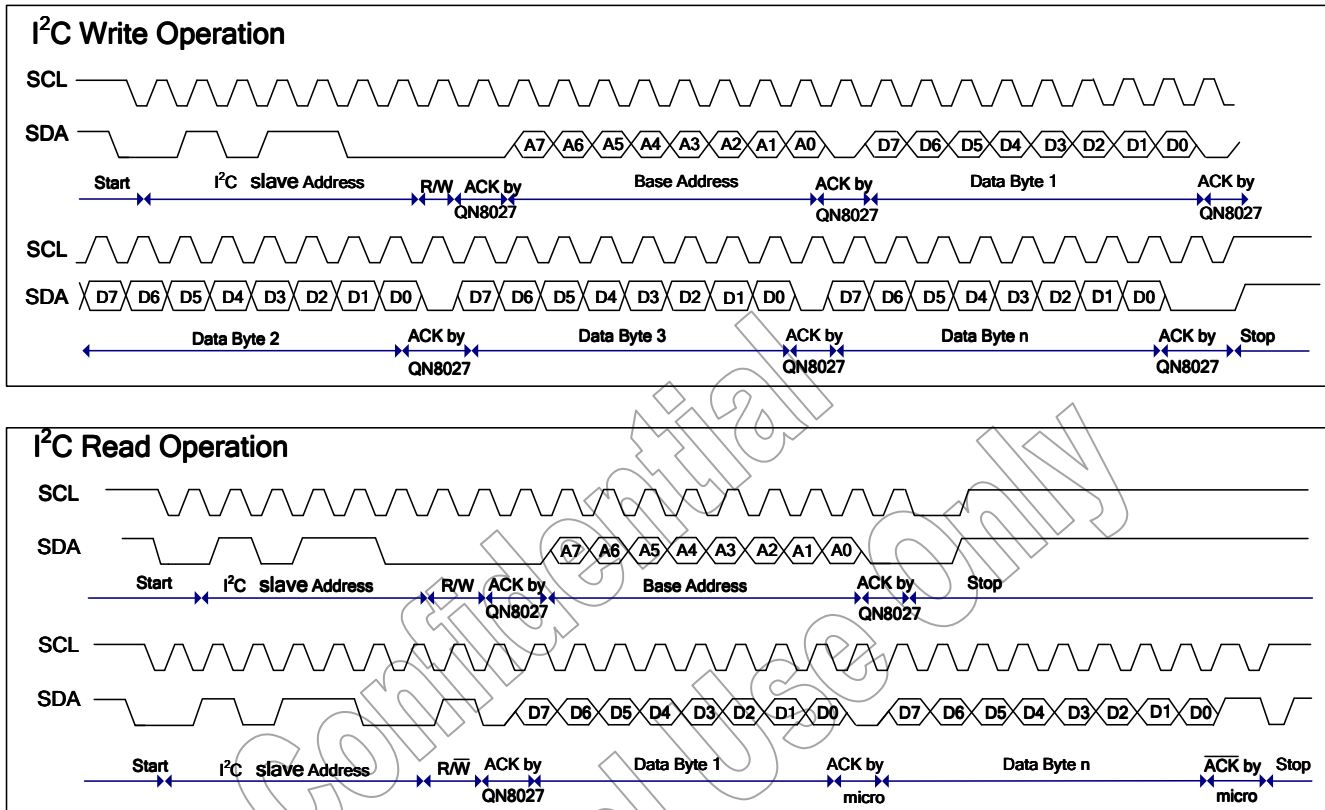

**Figure 4: I<sup>2</sup>C Serial Control Interface Protocol**

Notes:

1. The default IC address is 0x2C.
2. "0x58" for a WRITE operation, "0x59" for a READ operation.

## 6 USER CONTROL REGISTERS

----- THIS IS A PREVIEW LIST. Number and content of registers subject to change without notice -----

There are 19 user accessible control registers. All registers not listed below are for manufacturing use only.

**Table 9: Summary of User Control Registers**

REGISTER	NAME	USER CONTROL FUNCTIONS
00h	SYSTEM	Sets device modes, resets.
01h	CH1	Lower 8 bits of 10-bit channel index.
02h	GPLT	Audio controls, gain of TX pilot frequency deviation.
03h	REG_XTL	XCLK pin control.
04h	REG_VGA	TX mode input impedance, crystal frequency setting.
05h	CID1	Device ID numbers.
06h	CID2	Device ID numbers.
07h	STATUS	Device status indicators.
08h	RDSD0	RDS data byte 0.
09h	RDSD1	RDS data byte 1.
0Ah	RDSD2	RDS data byte 2.
0Bh	RDSD3	RDS data byte 3.
0Ch	RDSD4	RDS data byte 4.
0Dh	RDSD5	RDS data byte 5.
0Eh	RDSD6	RDS data byte 6.
0Fh	RDSD7	RDS data byte 7.
10h	PAC	PA output power target control.
11h	FDEV	Specify total TX frequency deviation.
12h	RDS	Specify RDS frequency deviation, RDS mode selection.

## Register Bit R/W Status:

*RO* - Read Only: You can not program these bits.

*WO* - Write Only: You can write and read these bits; the value you read back will be the same as written.

*R/W* - Read/Write: You can write and read these bits; the value you read back can be different from the value written.

Typically, the value is set by the chip itself.

**Word: SYSTEM      Address: 00h**

Bit 7 (MSB)	Bit 6	Bit 5	Bit 4	Bit 3	Bit 2	Bit 1	Bit 0 (LSB)
swrst	recal	txreq	mono	mute	rdsrdy	ch[9]	ch[8]
r/w	wo	wo	wo	wo	wo	wo	wo

Bit	Symbol	Default	Description	
7	SWRST	0	Reset all registers to default values	
			0	Keep the current value.
			1	Reset to default values.
6	RECAL	0	Reset the state to initial states and recalibrate all blocks.	
			0	No reset. FSM runs normally.
			1	Reset the FSM. After this bit is de-asserted, FSM will go through all the power up and calibration sequence.
5	TXREQ	0	Transmission request:	
			0	Stay in IDLE mode.
			1	Enter Transmit mode.
4	MONO	0	Force MONO mode for transmission:	
			0	Stereo mode.
			1	MONO mode.
3	MUTE	0	Audio Mute enable:	
			0	Not Mute
			1	Mute
2	RDSRDY	0	RDS transmitting ready: If user want the chip transmitting all the 8 bytes in RDS0~RDS7, user should toggle this bit. Then the chip internally will fetch these bytes after completing transmitting of current group.	
1:0	CH[9:8]	01	Highest 2 bits of 10-bit channel index: Channel freq is (76+CH*0.05) MHz	



**Word: CH1**

**Address: 01h**

Bit 7 (MSB)	Bit 6	Bit 5	Bit 4	Bit 3	Bit 2	Bit 1	Bit 0 (LSB)
ch[7]	ch[6]	ch[5]	ch[4]	ch[3]	ch[2]	ch[1]	ch[0]
wo	wo	wo	wo	wo	wo	wo	wo

Bit	Symbol	Default	Description
7:0	CH[7:0]	0000 0000	Lower 8 bits of 10-bit Channel index. Channel used for TX.

**Word: GPLT**

**Address: 02h**

Bit 7 (MSB)	Bit 6	Bit 5	Bit 4	Bit 3	Bit 2	Bit 1	Bit 0 (LSB)
tc	priv_en	T1m_sel[1]	T1m_sel[0]	gain_txplt[3]	gain_txplt[2]	gain_txplt[1]	gain_txplt[0]
wo	wo	wo	wo	wo	wo	wo	wo

Bit	Symbol	Default	Description	
7	TC	1	Pre-emphasis time constant	
			TC	Time constant (us)
			0	50
			1	75
6	priv_en	0	Enable the privacy mode (audio scramble and RDS encryption)	
			priv_en	Privacy mode
			0	disabled
		1	enabled	
5:4	t1m_sel[1:0]	10	Selection of 1 minute time for PA off when no audio.	
			The real time is (58+t1m_sel) seconds	
			T1m_sel[1:0]	time
			00	58s
			01	59s
			10	60s
11	Infinity (never)			
3:0	GAIN_TXPLT[3:0]	1001	Gain of TX pilot to adjust pilot frequency deviation. Refer to peak frequency deviation of MPX signal when audio input is full scale.	
			GAIN_TXPLT[5:0]	value
			0111	7% * 75KHz

			1000	8% * 75KHz
			1001	9% * 75KHz
			1010	10% * 75KHz

**Word:** REG\_XTL      **Address:** 03h

Bit 7	Bit 6	Bit 5	Bit 4	Bit 3	Bit 2	Bit 1	Bit 0
xinj[1]	xinj[0]	xisel[5]	xisel[4]	xisel[3]	xisel[2]	xisel[1]	xisel[0]
wo	wo	wo	wo	wo	wo	wo	wo

Bit	Symbol	Default	Description	
7:6	XINJ[1:0]	00	Select the reference clock source	
			XINJ[1:0]	Clock source
			00	Use crystal on XTAL1/XTAL2
			01	Inject digital clock from XTAL1
			10	Single end sine-wave injection on XTAL1
			11	Differential sine-wave injection on XTAL1/2
5:0	XISEL[5:0]	010000	Crystal oscillator current control. 6.25uA*XISEL[5:0], 0-400uA when use crystal on XTAL1/XTAL2.	

**Word:** REG\_VGA      **Address:** 04h

Bit 7 (MSB)	Bit 6	Bit 5	Bit 4	Bit 3	Bit 2	Bit 1	Bit 0 (LSB)
xsel	gvga[2]	gvga[1]	gvga[0]	GDB[1]	GDB[0]	rin[1]	rin[0]
wo	wo	wo	wo	wo	wo	wo	wo

Bit	Symbol	Default	Description		
7	XSEL	1	Crystal frequency selection		
			XSEL	XTAL frequency (MHz)	
			0	12	
			1	24	
6:4	GVGA[2:0]	011	TX input buffer gain (dB)		
			VGAG[2:0]	RIN[1:0]	
			00	01	10
	000	3	-3	-9	-15

			001	6	0	-6	-12
			010	9	3	-3	-9
			011	12	6	0	-6
			100	15	9	3	-3
			101	18	12	6	0
			11X	Reserved			
3:2	GDB[1:0]	00	TX digital gain				
			GDB[1:0]	Digital gain			
			00	0 dB			
			01	1 dB			
			10	2 dB			
			11	reserved			
1:0	RIN[1:0]	10	TX mode input impedance for both L/R channels.				
			RIN[1:0]	Input impedance (K $\Omega$ )			
			00	5			
			01	10			
			10	20			
			11	40			

**Word: CID1**

**Address: 05h (RO)**

Bit 7 (MSB)	Bit 6	Bit 5	Bit 4	Bit 3	Bit 2	Bit 1	Bit 0 (LSB)
cid0[2]	cid0[1]	cid0[0]	cid1[2]	cid1[1]	cid1[0]	cid2[1]	cid2[0]
ro	ro	ro	ro	ro	ro	ro	ro

Bit	Symbol	Default	Description	
7:5	CID0[2:0]	rrr	reserved	
4:2	CID1[2:0]	rrr 000	Chip ID for product family	
			CID1[2:0]	Product Family
			000	FM
			001-111	reserved
1:0	CID2[1:0]	rr 00	Chip ID for minor revision	
			CID2[1:0]	Minor revision
			00	1
			01	2

			10	3
			11	4

**Word: CID2**

**Address: 06h (RO)**

Bit 7 (MSB)	Bit 6	Bit 5	Bit 4	Bit 3	Bit 2	Bit 1	Bit 0 (LSB)
cid3[3]	cid3[2]	cid3[1]	cid3[0]	cid4[3]	cid4[2]	cid4[1]	cid4[0]
ro	ro	ro	ro	ro	ro	ro	ro

Bit	Symbol	Default	Description	
7:4	CID3[3:0]	rrrr 0100	Chip ID for product ID	
			CID3[2:0]	Product
			0100	QN8027
			others	reserved
3:0	CID4[3:0]	rrrr 0000	Chip ID for major revision is 1+CID4	
			CID4[3:0]	Revision number
			0000	1
			0001	2
			0010	3
			0011	4
			0100-1111	reserved

**Word: STATUS**

**Address: 07h**

Bit 7 (MSB)	Bit 6	Bit 5	Bit 4	Bit 3	Bit 2	Bit 1	Bit 0 (LSB)
aud_pk[3]	aud_pk[2]	aud_pk[1]	aud_pk[0]	rds_upd	fsm[2]	fsm[1]	fsm[0]
ro	ro	ro	ro	ro	ro	ro	ro

Bit	Symbol	Default	Description
-----	--------	---------	-------------

7:4	aud_pk[3:0]	rrrr	Audio peak value at ADC input is aud_pk[3:0]*45mV	
3	RDS_UPD	r	RDS TX: To transmit the 8 bytes in RDS0~RDS7, the user should toggle the register bit RDSRDY. Then the chip internally fetches these bytes after completing transmitting the current group. Once the chip has internally fetched these bytes, it will toggle this bit, and the user can write in another group.	
2:0	FSM[2:0]	rrr	Top FSM state code	
			FSM[2:0]	FSM status
			000	RESET
			001	CALI
			010	IDLE
			011	PA calibration
			100	Transmit
			101	PA_OFF
			110	TX ready
			111	reserved

**Word: RDSD0      Address: 08h**

Bit 7 (MSB)	Bit 6	Bit 5	Bit 4	Bit 3	Bit 2	Bit 1	Bit 0 (LSB)
rdsd0[7]	rdsd0[6]	rdsd0[5]	rdsd0[4]	rdsd0[3]	rdsd0[2]	rdsd0[1]	rdsd0[0]
wo	wo	wo	wo	wo	wo	wo	wo

Bit	Symbol	Default	Description
7:0	RDSD0	00000000	RDS data byte0 to be sent: Data written into RDSD0~RDSD7 can not be sent out if user didn't toggle RDSTXRDY to allow the data to be loaded into the internal transmitting buffer.

**Word: RDSD1      Address: 09h**

Bit 7 (MSB)	Bit 6	Bit 5	Bit 4	Bit 3	Bit 2	Bit 1	Bit 0 (LSB)
rdsd1[7]	rdsd1[6]	rdsd1[5]	rdsd1[4]	rdsd1[3]	rdsd1[2]	rdsd1[1]	rdsd1[0]

WO	WO	WO	WO	WO	WO	WO	WO
----	----	----	----	----	----	----	----

Bit	Symbol	Default	Description
7:0	RDSD1[7:0]	0000 0000	RDS data byte 1

**Word: RDSD2      Address: 0Ah**

Bit 7 (MSB)	Bit 6	Bit 5	Bit 4	Bit 3	Bit 2	Bit 1	Bit 0 (LSB)
rdsd2[7]	rdsd2[6]	rdsd2[5]	rdsd2[4]	rdsd2[3]	rdsd2[2]	rdsd2[1]	rdsd2[0]
wo	wo	wo	wo	wo	wo	wo	wo

Bit	Symbol	Default	Description
7:0	RDSD2[7:0]	0000 0000	RDS data byte 2

**Word: RDSD3      Address: 0Bh**

Bit 7 (MSB)	Bit 6	Bit 5	Bit 4	Bit 3	Bit 2	Bit 1	Bit 0 (LSB)
rdsd3[7]	rdsd3[6]	rdsd3[5]	rdsd3[4]	rdsd3[3]	rdsd3[2]	rdsd3[1]	rdsd3[0]
wo	wo	wo	wo	wo	wo	wo	wo

Bit	Symbol	Default	Description
7:0	RDSD3[7:0]	0000 0000	RDS data byte 3

**Word: RDSD4      Address: 0Ch**

Bit 7 (MSB)	Bit 6	Bit 5	Bit 4	Bit 3	Bit 2	Bit 1	Bit 0 (LSB)
rdsd4[7]	rdsd4[6]	rdsd4[5]	rdsd4[4]	rdsd4[3]	rdsd4[2]	rdsd4[1]	rdsd4[0]
wo	wo	wo	wo	wo	wo	wo	wo

Bit	Symbol	Default	Description
7:0	RDSD4[7:0]	0000 0000	RDS data byte 4

**Word:** RSD5

**Address:** 0Dh

Bit 7 (MSB)	Bit 6	Bit 5	Bit 4	Bit 3	Bit 2	Bit 1	Bit 0 (LSB)
rdsd5[7]	rdsd5[6]	rdsd5[5]	rdsd5[4]	rdsd5[3]	rdsd5[2]	rdsd5[1]	rdsd5[0]
wo	wo	wo	wo	wo	wo	wo	wo

Bit	Symbol	Default	Description
7:0	RSD5[7:0]	0000 0000	RDS data byte 5

**Word:** RSD6

**Address:** 0Eh

Bit 7 (MSB)	Bit 6	Bit 5	Bit 4	Bit 3	Bit 2	Bit 1	Bit 0 (LSB)
rdsd6[7]	rdsd6[6]	rdsd6[5]	rdsd6[4]	rdsd6[3]	rdsd6[2]	rdsd6[1]	rdsd6[0]
wo	wo	wo	wo	wo	wo	wo	wo

Bit	Symbol	Default	Description
7:0	RSD6[7:0]	0000 0000	RDS data byte 6

**Word:** RSD7

**Address:** 0Fh

Bit 7 (MSB)	Bit 6	Bit 5	Bit 4	Bit 3	Bit 2	Bit 1	Bit 0 (LSB)
rdsd7[7]	rdsd7[6]	rdsd7[5]	rdsd7[4]	rdsd7[3]	rdsd7[2]	rdsd7[1]	rdsd7[0]
wo	wo	wo	wo	wo	wo	wo	wo

Bit	Symbol	Default	Description
7:0	RSD7[7:0]	0000 0000	RDS data byte 7

**Word:** PAC

**Address:** 10h

Bit 7 (MSB)	Bit 6	Bit 5	Bit 4	Bit 3	Bit 2	Bit 1	Bit 0 (LSB)
txpd_clr	pa_trgt[6]	pa_trgt[5]	pa_trgt[4]	pa_trgt[3]	pa_trgt[2]	pa_trgt[1]	pa_trgt[0]

WO	WO	WO	WO	WO	WO	WO	WO
----	----	----	----	----	----	----	----

Bit	Symbol	Default	Description
7	TXPD_CLR	0	TX aud_pk clear signal: Audio peak value is max-hold and stored in aud_pk[3:0]. Once TXPD_CLR is toggled, the aud_pk value is cleared and restarted again.
6:0	PA_TRGT[6:0]	111 1111	PA output power target is $0.62 * PA\_TRGT + 71\text{dBu}$ . Valid values are 20-75.

**Word:** FDEV

**Address:** 11h

Bit 7 (MSB)	Bit 6	Bit 5	Bit 4	Bit 3	Bit 2	Bit 1	Bit 0 (LSB)
tx_fdev[7]	tx_fdev[6]	tx_fdev[5]	tx_fdev[4]	tx_fdev[3]	tx_fdev[2]	tx_fdev[1]	tx_fdev[0]
WO	WO	WO	WO	WO	WO	WO	WO

Bit	Symbol	Default	Description	
7:0	TX_FDEV[7:0]	10000001	Specify total TX frequency deviation: TX frequency deviation = $0.58 \text{ kHz} * TX\_FDEV$ .	
			TX_FDEV[7:0]	value
			0000 0000 - 1111 1111	0 ~ 255

**Word:** RDS

**Address:** 12h

Bit 7 (MSB)	Bit 6	Bit 5	Bit 4	Bit 3	Bit 2	Bit 1	Bit 0 (LSB)
rdsen	rdsfdev[6]	rdsfdev[5]	rdsfdev[4]	rdsfdev[3]	rdsfdev[2]	rdsfdev[1]	rdsfdev[0]
WO	WO	WO	WO	WO	WO	WO	WO

Bit	Symbol	Default	Description	
7	RDSEN	0	RDS enable:	
			0	RDS disable
			1	RDS enable
6	RDSFDEV[6:0]	000 0110	Specify RDS frequency deviation: RDS frequency deviation = $0.35\text{KHz} * RDSFDEV$ .	
			RDSFDEV[6:0]	Value
			000 0000 - 111 1111	0~127



## 7 ORDERING INFORMATION

Part Number	Description	Package
QN8027-SANB	The QN8027 is a high performance, low power, full-featured single-chip stereo FM transmitter designed for portable audio/video players, automotive accessories, cell phones, and GPS personal navigation devices.	3x3 mm Body [MSOP10]

Confidential  
Internal Use Only

## 8 PACKAGE DESCRIPTION

### 10-Lead plastic package – 3x3 mm Body [MSOP]

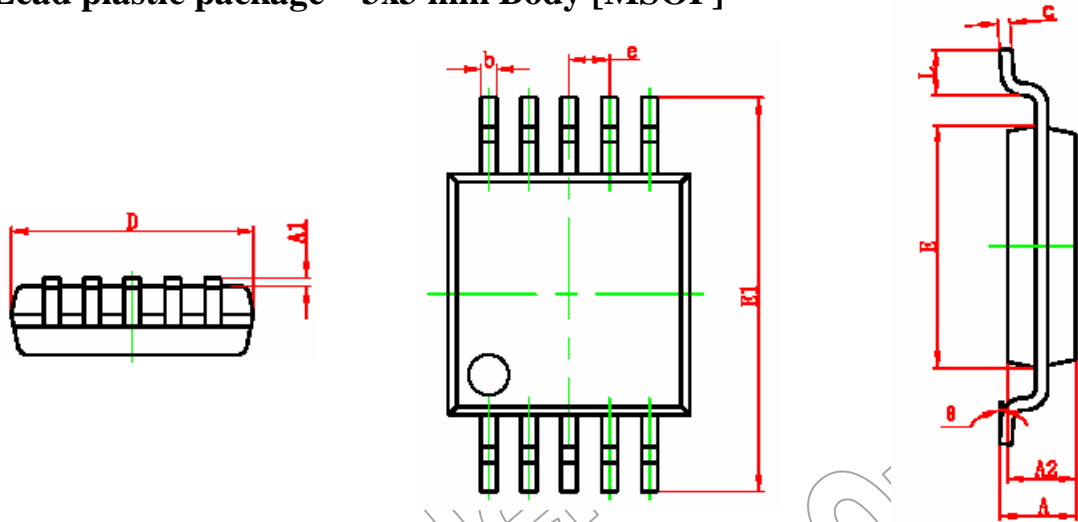

**Figure 5: MSOP10 Package Outline Dimensions**

Symbol	Description	Millimeters		
		Minimum	Nominal	Maximum
A	Overall package height	0.820	0.95	1.100
A1	Board standoff	0.020	-	0.150
A2	Package thickness	0.750	0.85	0.950
b	Lead width	0.180	0.23	0.280
c	Lead thickness	0.090	-	0.230
D	Package's outside, X-axis	2.900	3.00	3.100
e	Lead pitch	0.50 (BSC)		
E	Package's outside, Y-axis	2.900	3.00	3.100
E1	Lead to lead, Y-axis	4.750	4.90	5.050
L	Foot length	0.400	0.60	0.800
$\theta$	Foot to board angle	0°	-	6°

Notes:

1. Pin 1 visual index feature may vary, but must be located within the area indicated in the drawing.
2. Dimensioning and tolerance per ASME Y 14.5M.  
BSC: Basic Dimension. The theoretically exact value is shown without tolerance.

**Carrier Tape Dimensions**

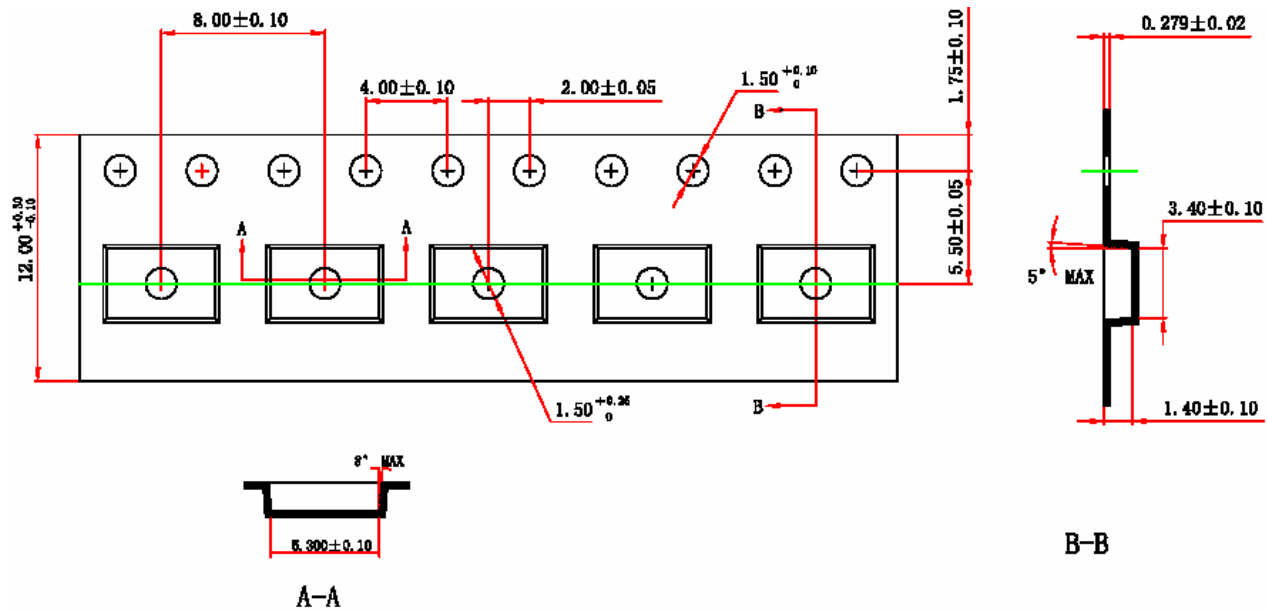

**Figure 6: MSOP10 Carrier Tape Drawing**

**NOTES:**

1. 10 sprocket hole pitch cumulative tolerance  $\pm 0.2$ mm maximum.
2. Camber not to exceed 1mm in 100mm:  $\leq 1$ mm/100mm.
3. Pocket position relative to sprocket hole measured as true position of pocket, not pocket hole.

## 9 SOLDER REFLOW PROFILE

### 9.1 Package Peak Reflow Temperature

QN8027 is assembled in a lead-free MSOP package. Since the geometrical size of QN8027 is 3 mm × 3 mm × 0.95 mm, the volume and thickness is in the category of volume < 350 mm<sup>3</sup> and thickness < 1.6 mm in Table 4-2 of IPC/JEDEC J-STD-020C. The peak reflow temperature is:

$$T_p = 260^{\circ}\text{C}$$

The temperature tolerance is +0°C and -5°C. Temperature is measured at the top of the package.

### 9.2 Classification Reflow Profiles

Profile Feature		Specification*
Average Ramp-Up Rate (tsmax to tP)		3°C/second max.
Pre-heat:	Temperature Min (T <sub>min</sub> )	150°C
	Temperature Max (T <sub>max</sub> )	200°C
	Time (ts)	60-180 seconds
Time maintained above:	Temperature (T <sub>L</sub> )	217°C
	Time (t <sub>L</sub> )	60-150 seconds
Peak/Classification Temperature (T <sub>p</sub> )		260°C
Time within 5°C of Actual Peak Temperature (tp)		20 -40 seconds
Ramp-Down Rate		6°C/second max.
Time 25°C to Peak Temperature		8 minutes max.

\*Note: All temperatures are measured at the top of the package.

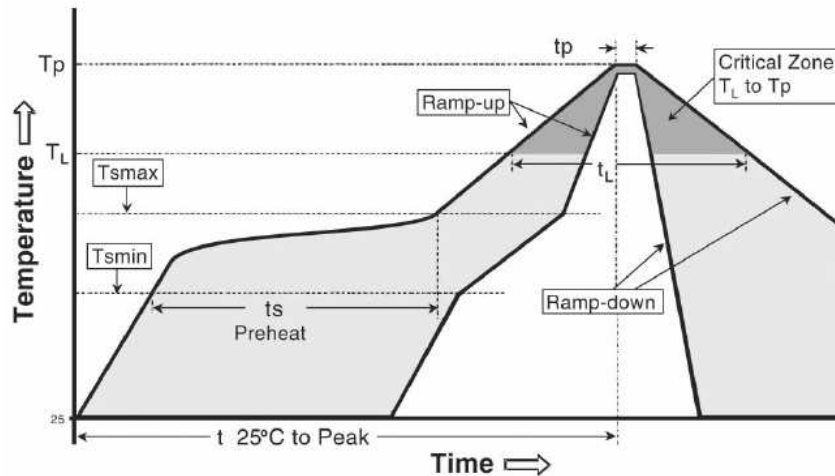

**Figure 7: Reflow Temperature Profile**

### 9.3 Maximum Reflow Times

All package reliability tests were performed and passed with a pre-condition procedure that repeat a reflow profile, which conforms to the requirements in **Section 9.2, three (3) times**.

Confidential  
Internal Use Only

### CONTACT INFORMATION

**Quintic Corporation (USA)**

3211 Scott Blvd., Suite 203  
Santa Clara, CA 95054  
Tel: +1.408.970.8808  
Fax: +1.408.970.8829  
Email: [support@quinticcorp.com](mailto:support@quinticcorp.com)  
Web: [www.quinticcorp.com](http://www.quinticcorp.com)

**Quintic Microelectronics (China)**

Building 8 B-301A Tsinghua Science Park  
1st East Zhongguancun Rd, Haidian  
Beijing, China 100084  
Tel: +86 (10) 8215-1997  
Fax: +86 (10) 8215-1570  
Web: [www.quinticcorp.com](http://www.quinticcorp.com)

Quintic Microelectronics and Quintic are trademarks of Quintic Corporation. All Rights Reserved.