

The RF MOSFET Line
RF Power Field Effect Transistors
N-Channel Enhancement-Mode Lateral MOSFETs

MRF9120
MRF9120S

Designed for broadband commercial and industrial applications with frequencies from 865 to 895 MHz. The high gain and broadband performance of these devices make them ideal for large-signal, common source amplifier applications in 26 volt base station equipment.

- Typical CDMA Performance @ 880 MHz, 26 Volts, $I_{DQ} = 2 \times 500$ mA
IS-97 CDMA Pilot, Sync, Paging, Traffic Codes 8 Through 13
Output Power — 26 Watts
Power Gain — 16 dB
Efficiency — 26%
Adjacent Channel Power —
750 kHz: -45 dBc @ 30 kHz BW
1.98 MHz: -60 dBc @ 30 kHz BW
- Integrated ESD Protection
- Designed for Maximum Gain and Insertion Phase Flatness
- Capable of Handling 10:1 VSWR, @ 26 Vdc, 880 MHz, 120 Watts (CW) Output Power
- Excellent Thermal Stability
- Characterized with Series Equivalent Large-Signal Impedance Parameters

880 MHz, 120 W, 26 V
LATERAL N-CHANNEL
RF POWER MOSFETs

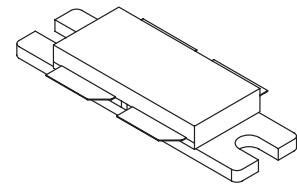

CASE 375B-04, STYLE 1
NI-860
MRF9120

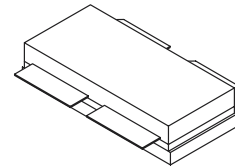

CASE 375H-03, STYLE 1
NI-860S
MRF9120S

MAXIMUM RATINGS

Rating	Symbol	Value	Unit
Drain-Source Voltage	V_{DSS}	65	Vdc
Gate-Source Voltage	V_{GS}	- 0.5, +15	Vdc
Total Device Dissipation @ $T_C = 25^\circ\text{C}$ Derate above 25°C	P_D	250 1.43	Watts W/ $^\circ\text{C}$
Storage Temperature Range	T_{stg}	- 65 to +150	$^\circ\text{C}$
Operating Junction Temperature	T_J	200	$^\circ\text{C}$

ESD PROTECTION CHARACTERISTICS

Test Conditions	Class
Human Body Model	1 (Minimum)
Machine Model	M1 (Minimum)

THERMAL CHARACTERISTICS

Characteristic	Symbol	Max	Unit
Thermal Resistance, Junction to Case	$R_{\theta JC}$	0.45	$^\circ\text{C}/\text{W}$

NOTE - **CAUTION** - MOS devices are susceptible to damage from electrostatic charge. Reasonable precautions in handling and packaging MOS devices should be observed.

ELECTRICAL CHARACTERISTICS ($T_C = 25^\circ\text{C}$ unless otherwise noted)

Characteristic	Symbol	Min	Typ	Max	Unit
OFF CHARACTERISTICS ⁽¹⁾					
Zero Gate Voltage Drain Leakage Current ($V_{DS} = 65\text{ Vdc}$, $V_{GS} = 0\text{ Vdc}$)	I_{DSS}	—	—	10	μAdc
Zero Gate Voltage Drain Leakage Current ($V_{DS} = 26\text{ Vdc}$, $V_{GS} = 0\text{ Vdc}$)	I_{DSS}	—	—	1	μAdc
Gate–Source Leakage Current ($V_{GS} = 5\text{ Vdc}$, $V_{DS} = 0\text{ Vdc}$)	I_{GSS}	—	—	1	μAdc
ON CHARACTERISTICS ⁽¹⁾					
Gate Threshold Voltage ($V_{DS} = 10\text{ Vdc}$, $I_D = 200\ \mu\text{Adc}$)	$V_{GS(th)}$	2	3	4	Vdc
Gate Quiescent Voltage ($V_{DS} = 26\text{ Vdc}$, $I_D = 450\text{ mAdc}$)	$V_{GS(Q)}$	—	3.8	—	Vdc
Drain–Source On–Voltage ($V_{GS} = 10\text{ Vdc}$, $I_D = 1.3\text{ Adc}$)	$V_{DS(on)}$	—	0.17	0.4	Vdc
Forward Transconductance ($V_{DS} = 10\text{ Vdc}$, $I_D = 4\text{ Adc}$)	g_{fs}	—	5.3	—	S
DYNAMIC CHARACTERISTICS ⁽¹⁾					
Output Capacitance ($V_{DS} = 26\text{ Vdc} \pm 30\text{ mV(rms)ac}$ @ 1 MHz, $V_{GS} = 0\text{ Vdc}$)	C_{oss}	—	50	—	pF
Reverse Transfer Capacitance ($V_{DS} = 26\text{ Vdc} \pm 30\text{ mV(rms)ac}$ @ 1 MHz, $V_{GS} = 0\text{ Vdc}$)	C_{rss}	—	2	—	pF

(1) Each side of device measured separately.

(continued)

ELECTRICAL CHARACTERISTICS — continued ($T_C = 25^\circ\text{C}$ unless otherwise noted)

Characteristic	Symbol	Min	Typ	Max	Unit
FUNCTIONAL TESTS (In Motorola Test Fixture, 50 ohm system) (2)					
Two-Tone Common-Source Amplifier Power Gain ($V_{DD} = 26\text{ Vdc}$, $P_{out} = 120\text{ W PEP}$, $I_{DQ} = 2 \times 500\text{ mA}$, $f_1 = 880.0\text{ MHz}$, $f_2 = 880.1\text{ MHz}$)	G_{ps}	15	16.5	—	dB
Two-Tone Drain Efficiency ($V_{DD} = 26\text{ Vdc}$, $P_{out} = 120\text{ W PEP}$, $I_{DQ} = 2 \times 500\text{ mA}$, $f_1 = 880.0\text{ MHz}$, $f_2 = 880.1\text{ MHz}$)	η	36	39	—	%
3rd Order Intermodulation Distortion ($V_{DD} = 26\text{ Vdc}$, $P_{out} = 120\text{ W PEP}$, $I_{DQ} = 2 \times 500\text{ mA}$, $f_1 = 880.0\text{ MHz}$, $f_2 = 880.1\text{ MHz}$)	IMD	—	-31	-28	dBc
Input Return Loss ($V_{DD} = 26\text{ Vdc}$, $P_{out} = 120\text{ W PEP}$, $I_{DQ} = 2 \times 500\text{ mA}$, $f_1 = 880.0\text{ MHz}$, $f_2 = 880.1\text{ MHz}$)	IRL	—	-16	-9	dB
Two-Tone Common-Source Amplifier Power Gain ($V_{DD} = 26\text{ Vdc}$, $P_{out} = 120\text{ W PEP}$, $I_{DQ} = 2 \times 500\text{ mA}$, $f_1 = 895.0\text{ MHz}$, $f_2 = 895.1\text{ MHz}$)	G_{ps}	—	16.5	—	dB
Two-Tone Drain Efficiency ($V_{DD} = 26\text{ Vdc}$, $P_{out} = 120\text{ W PEP}$, $I_{DQ} = 2 \times 500\text{ mA}$, $f_1 = 895.0\text{ MHz}$, $f_2 = 895.1\text{ MHz}$)	η	—	40.5	—	%
3rd Order Intermodulation Distortion ($V_{DD} = 26\text{ Vdc}$, $P_{out} = 120\text{ W PEP}$, $I_{DQ} = 2 \times 500\text{ mA}$, $f_1 = 895.0\text{ MHz}$, $f_2 = 895.1\text{ MHz}$)	IMD	—	-30	—	dBc
Input Return Loss ($V_{DD} = 26\text{ Vdc}$, $P_{out} = 120\text{ W PEP}$, $I_{DQ} = 2 \times 500\text{ mA}$, $f_1 = 895.0\text{ MHz}$, $f_2 = 895.1\text{ MHz}$)	IRL	—	-13	—	dB
Power Output, 1 dB Compression Point ($V_{DD} = 26\text{ Vdc}$, $P_{out} = 120\text{ W CW}$, $I_{DQ} = 2 \times 500\text{ mA}$, $f_1 = 880.0\text{ MHz}$)	P_{1dB}	—	120	—	W
Common-Source Amplifier Power Gain ($V_{DD} = 26\text{ Vdc}$, $P_{out} = 120\text{ W CW}$, $I_{DQ} = 2 \times 500\text{ mA}$, $f_1 = 880.0\text{ MHz}$)	G_{ps}	—	16	—	dB
Drain Efficiency ($V_{DD} = 26\text{ Vdc}$, $P_{out} = 120\text{ W CW}$, $I_{DQ} = 2 \times 500\text{ mA}$, $f_1 = 880.0\text{ MHz}$)	η	—	51	—	%
Output Mismatch Stress ($V_{DD} = 26\text{ Vdc}$, $P_{out} = 120\text{ W CW}$, $I_{DQ} = 2 \times 500\text{ mA}$, $f = 880.0\text{ MHz}$, $VSWR = 10:1$, All Phase Angles at Frequency of Tests)	Ψ	No Degradation In Output Power			

(2) Device measured in push-pull configuration.

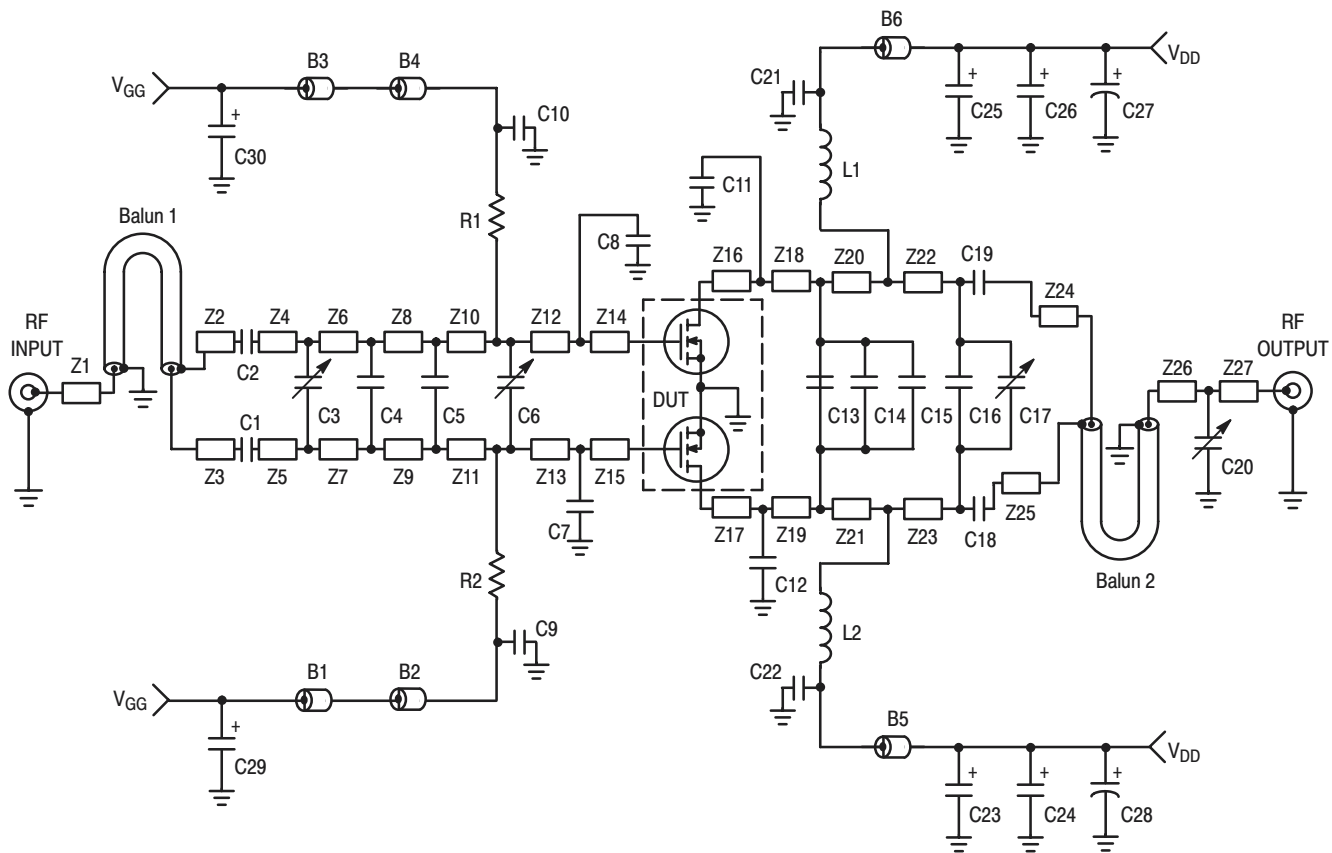

Z1	0.420" x 0.080" Microstrip	Z14, Z15	0.040" x 0.630" Microstrip
Z2, Z3	0.090" x 0.420" Microstrip	Z16, Z17	0.040" x 0.630" Microstrip
Z4, Z5	0.125" x 0.220" Microstrip	Z18, Z19	0.330" x 0.630" Microstrip
Z6, Z7	0.095" x 0.220" Microstrip	Z20, Z21	0.450" x 0.630" Microstrip
Z8, Z9	0.600" x 0.220" Microstrip	Z22, Z23	0.750" x 0.220" Microstrip
Z10, Z11	0.200" x 0.630" Microstrip	Z24, Z25	0.115" x 0.420" Microstrip
Z12, Z13	0.500" x 0.630" Microstrip	Z26	0.130" x 0.080" Microstrip
		Z27	0.350" x 0.080" Microstrip

Figure 1. 880 MHz Broadband Test Circuit Schematic

Table 1. 880 MHz Broadband Test Circuit Component Designations and Values

Part	Description	Value, P/N or DWG	Manufacturer
B1, B3, B5, B6	Long Ferrite Beads, Surface Mount	95F787	Newark
B2, B4	Short Ferrite Beads, Surface Mount	95F786	Newark
C1, C2	68 pF Chip Capacitors, B Case	100B680JP500X	ATC
C3, C6	0.8 – 8.0 pF Variable Capacitors	44F3360	Newark
C4	7.5 pF Chip Capacitor, B Case	100B7R5JP150X	ATC
C5	3.3 pF Chip Capacitor, B Case	100B3R3CP150X	ATC
C7, C8	11 pF Chip Capacitors, B Case	100B110BCA500X	ATC
C9, C10, C21, C22	51 pF Chip Capacitors, B Case	100B510JP500X	ATC
C11, C12	6.2 pF Chip Capacitors, B Case	100B6R2BCA150X	ATC
C13	4.7 pF Chip Capacitor, B Case	100B4R7BCA150X	ATC
C14	5.1 pF Chip Capacitor, B Case	100B5R1BCA150X	ATC
C15	3.0 pF Chip Capacitor, B Case	100B2R7BCA150X	ATC
C16	2.7 pF Chip Capacitor, B Case	100B3R0BCA150X	ATC
C17	0.6 – 4.5 pF Variable Capacitor	44F3358	Newark
C18, C19	47 pF Chip Capacitors, B Case	100B470JP500X	ATC
C20	0.4 – 2.5 pF Variable Capacitor	44F3367	Newark
C29, C30	10 μ F, 35 V Tantalum Chip Capacitors	93F2975	Newark
C23, C24, C25, C26	22 μ F, 35 V Tantalum Chip Capacitors	92F1853	Newark
C27, C28	220 μ F, 50 V Electrolytic Capacitors	14F185	Newark
Balun 1, Balun 2	Xinger Surface Mount Balun Transformers	3A412	Anaren
L1, L2	12.5 nH Mini Spring Inductors	A04T-5	Coilcraft
R1, R2	510 Ω , 1/4 W Chip Resistors		Garret
WB1, WB2, WB3, WB4	10 mil Brass Wear Blocks		
Board Material	30 mil Glass Teflon [®] , $\epsilon_r = 2.55$ Copper Clad, 2 oz Cu	900 MHz Push-Pull Rev 01B	CMR
PCB	Etched Circuit Board	900 MHz Push-Pull Rev 01B	CMR

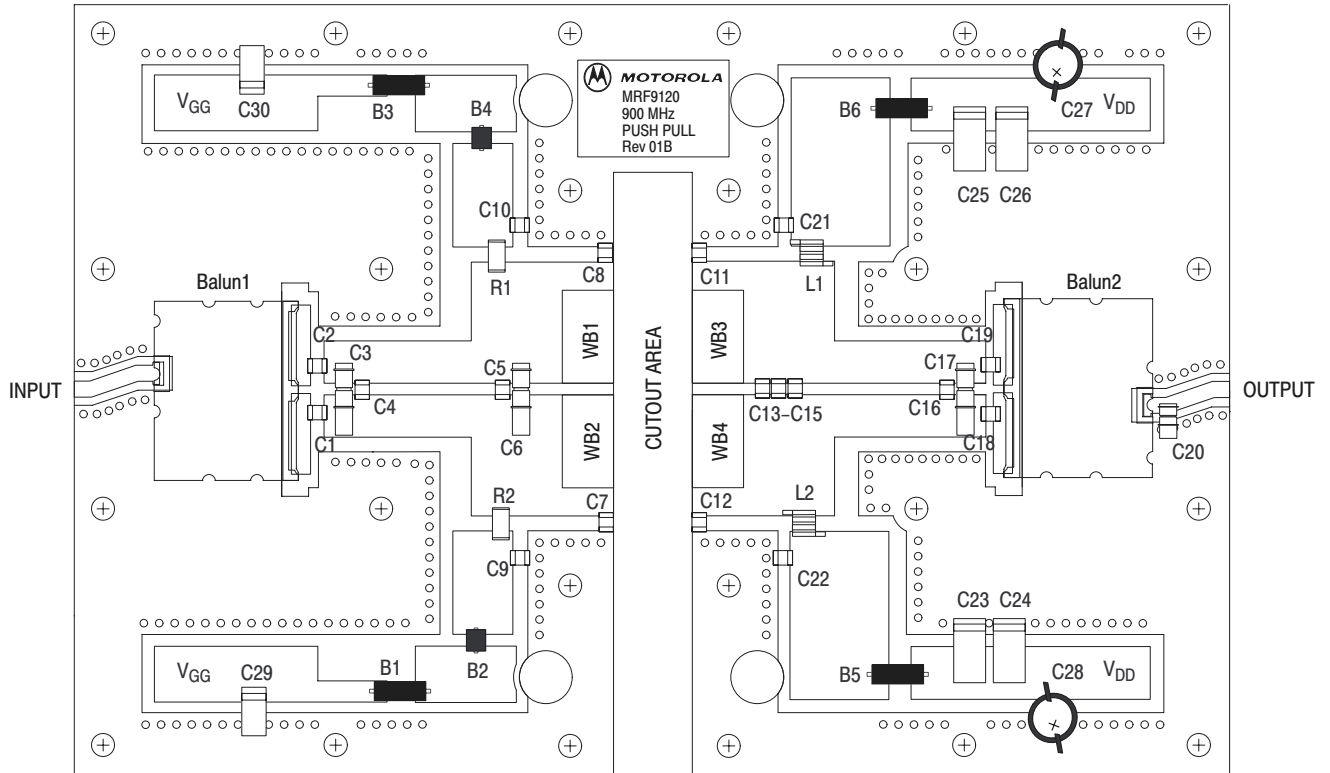

Figure 2. 865–895 MHz Broadband Test Circuit Component Layout

TYPICAL CHARACTERISTICS

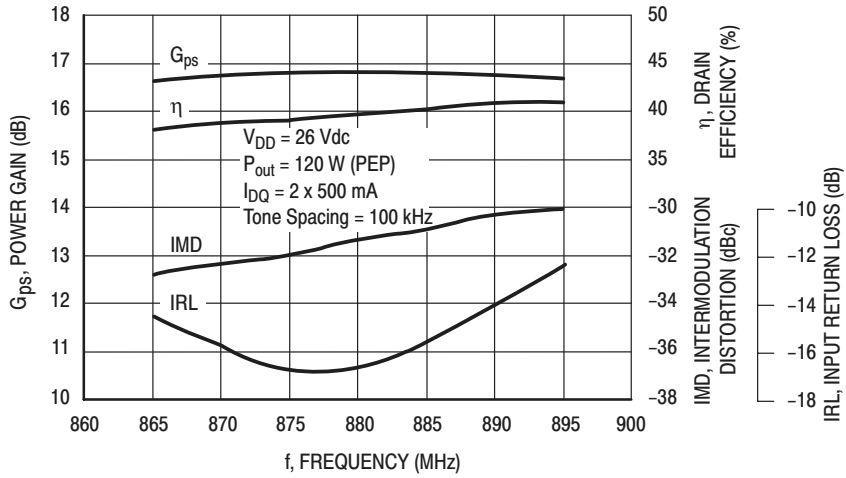

Figure 3. Class AB Broadband Circuit Performance

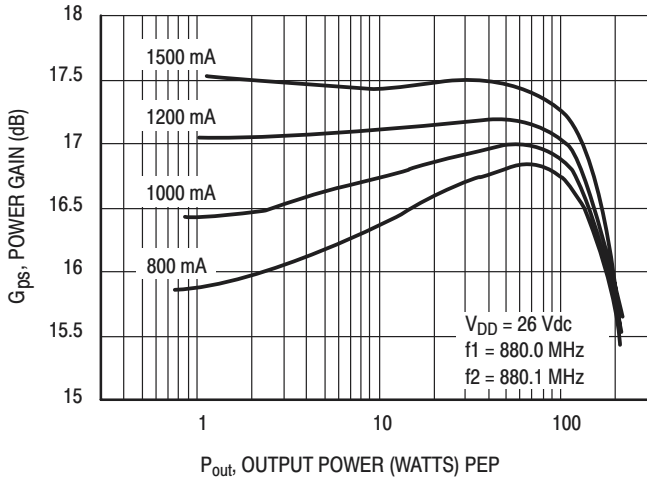

Figure 4. Power Gain versus Output Power

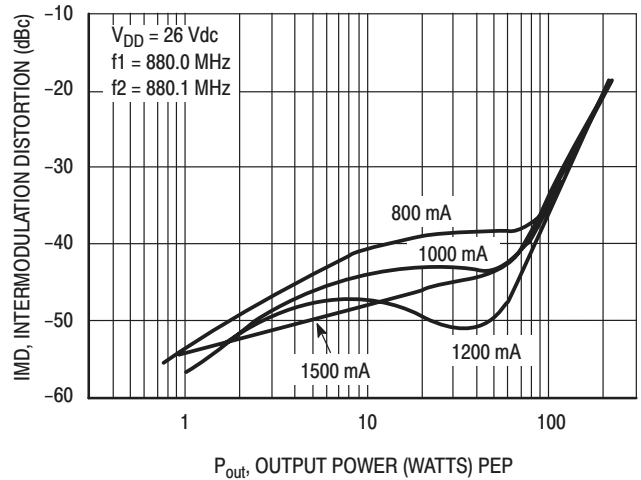

Figure 5. Intermodulation Distortion versus Output Power

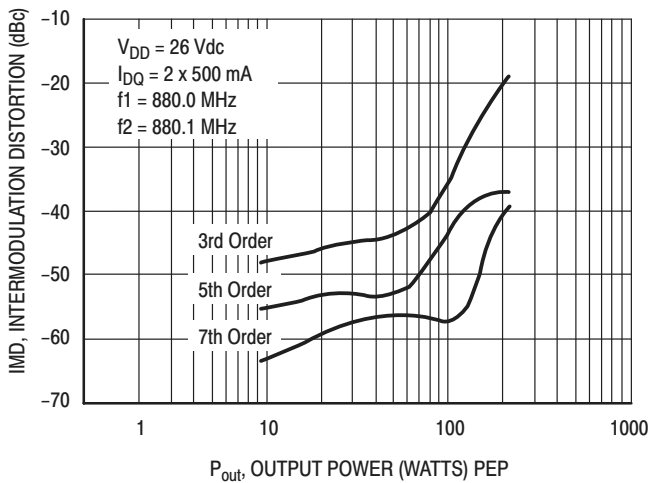

Figure 6. Intermodulation Distortion Products versus Output Power

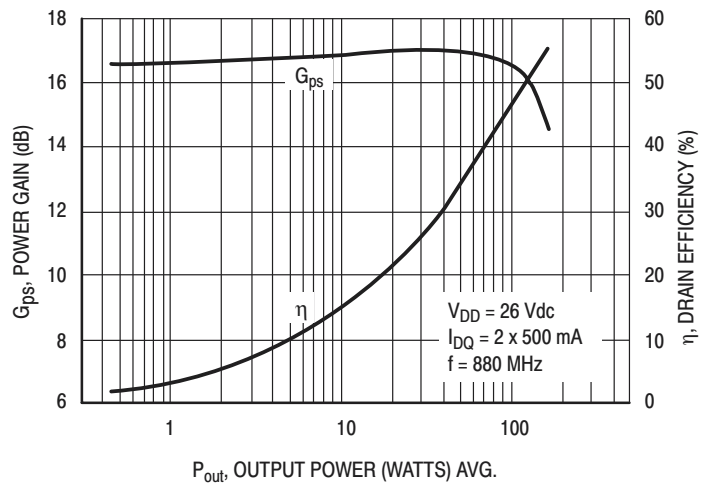

Figure 7. Power Gain and Efficiency versus Output Power

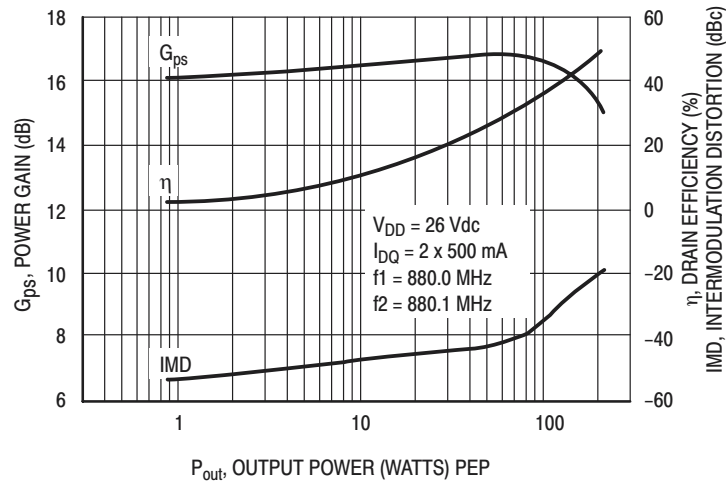

Figure 8. Power Gain, Efficiency and IMD versus Output Power

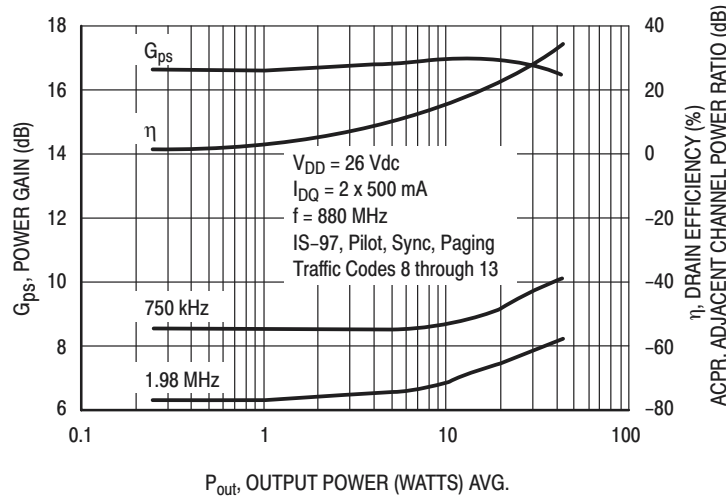
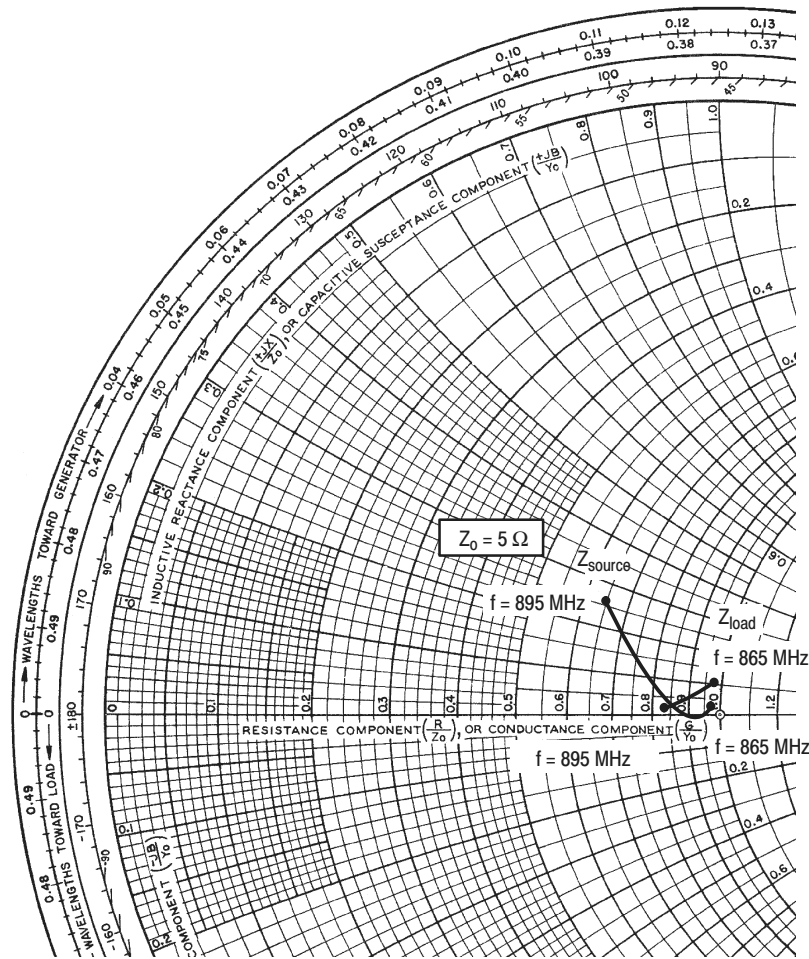

Figure 9. Power Gain, Efficiency and ACPR versus Output Power



$V_{DD} = 26 \text{ V}$, $I_{DQ} = 2 \times 500 \text{ mA}$, $P_{out} = 120 \text{ W PEP}$

f MHz	Z_{source} Ω	Z_{load} Ω
865	$4.89 + j0.2$	$4.9 + j0.5$
880	$4.54 - j0.07$	$4.6 + j0.32$
895	$3.29 + j1.3$	$4.2 + j0.04$

Z_{source} = Test circuit impedance as measured from gate to gate, balanced configuration.

Z_{load} = Test circuit impedance as measured from drain to drain, balanced configuration.

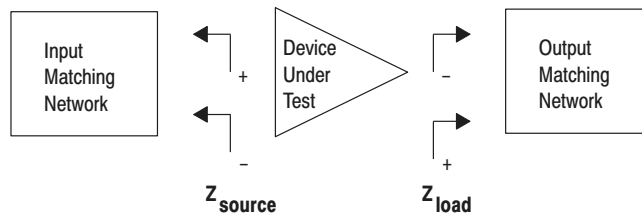
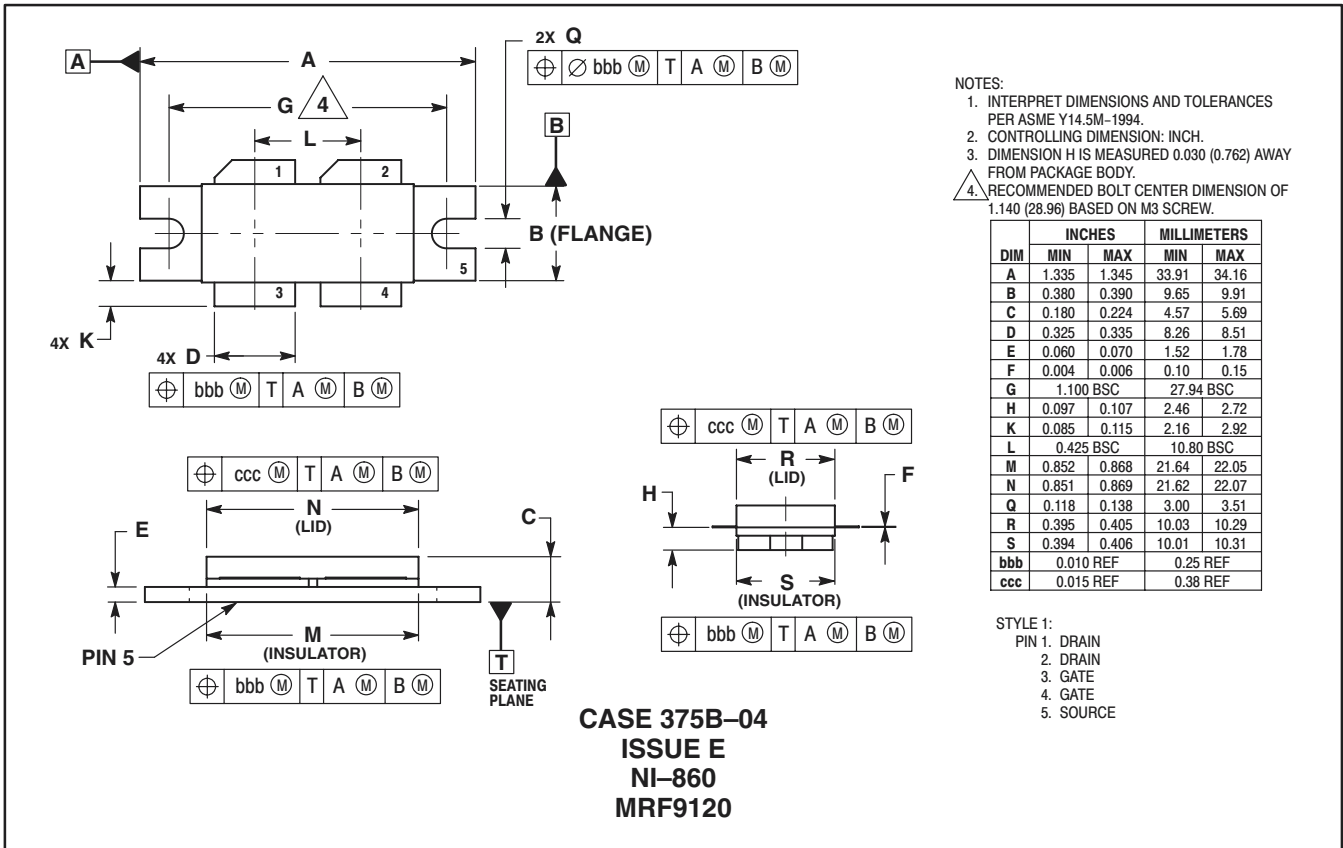

Figure 10. Series Equivalent Input and Output Impedance

NOTES

NOTES

PACKAGE DIMENSIONS



- NOTES:
1. INTERPRET DIMENSIONS AND TOLERANCES PER ASME Y14.5M-1994.
 2. CONTROLLING DIMENSION: INCH.
 3. DIMENSION H IS MEASURED 0.030 (0.762) AWAY FROM PACKAGE BODY.
 4. RECOMMENDED BOLT CENTER DIMENSION OF 1.140 (28.96) BASED ON M3 SCREW.

DIM	INCHES		MILLIMETERS	
	MIN	MAX	MIN	MAX
A	1.335	1.345	33.91	34.16
B	0.380	0.390	9.65	9.91
C	0.180	0.224	4.57	5.69
D	0.325	0.335	8.26	8.51
E	0.060	0.070	1.52	1.78
F	0.004	0.006	0.10	0.15
G	1.100 BSC		27.94 BSC	
H	0.097	0.107	2.46	2.72
K	0.085	0.115	2.16	2.92
L	.425 BSC		10.80 BSC	
M	0.852	0.868	21.64	22.05
N	0.851	0.869	21.62	22.07
Q	0.118	0.138	3.00	3.51
R	0.395	0.405	10.03	10.29
S	0.394	0.406	10.01	10.31
bbb	0.010 REF		0.25 REF	
ccc	0.015 REF		0.38 REF	

- STYLE 1:
- PIN 1. DRAIN
 2. DRAIN
 3. GATE
 4. GATE
 5. SOURCE

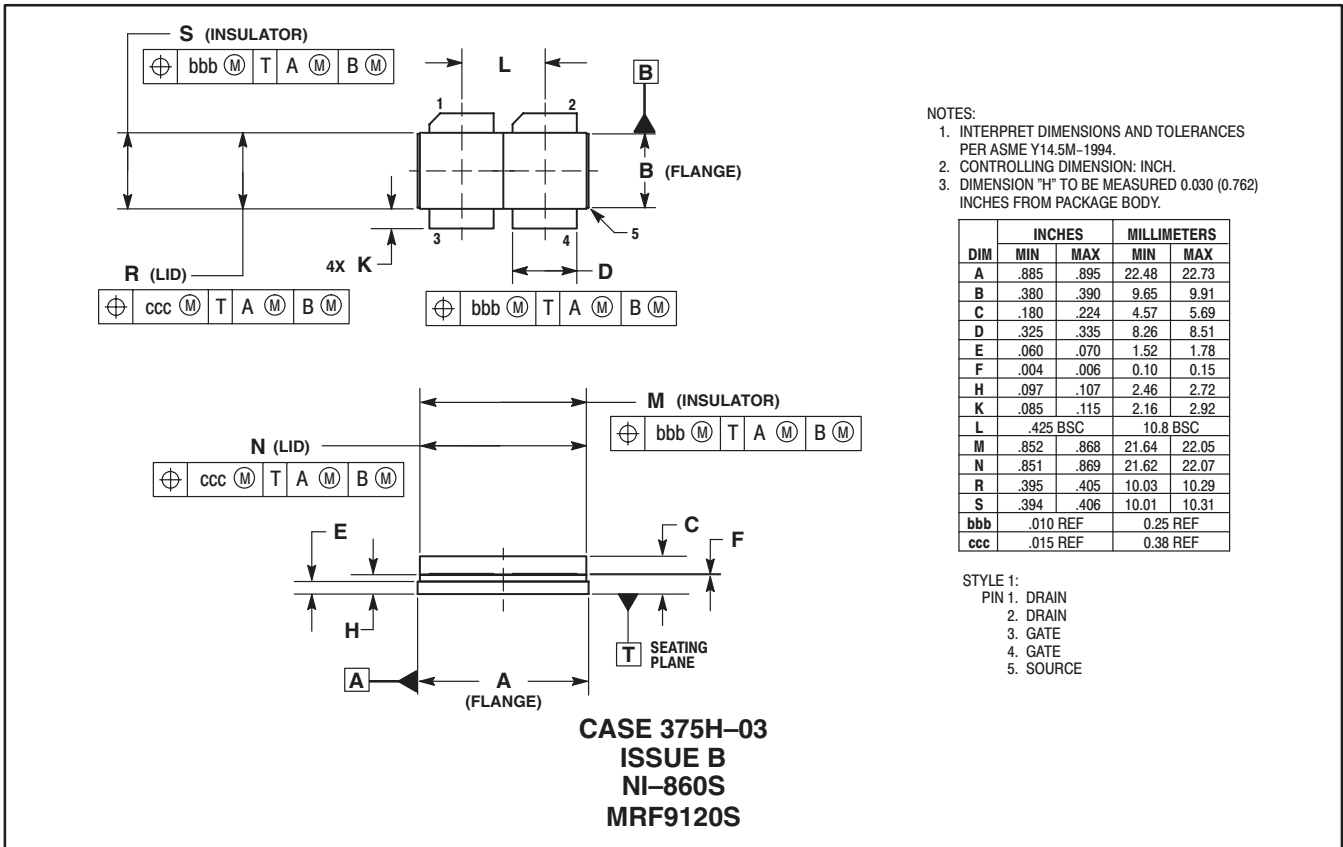

- NOTES:
1. INTERPRET DIMENSIONS AND TOLERANCES PER ASME Y14.5M-1994.
 2. CONTROLLING DIMENSION: INCH.
 3. DIMENSION "H" TO BE MEASURED 0.030 (0.762) INCHES FROM PACKAGE BODY.

DIM	INCHES		MILLIMETERS	
	MIN	MAX	MIN	MAX
A	.885	.895	22.48	22.73
B	.380	.390	9.65	9.91
C	.180	.224	4.57	5.69
D	.325	.335	8.26	8.51
E	.060	.070	1.52	1.78
F	.004	.006	0.10	0.15
H	.097	.107	2.46	2.72
K	.085	.115	2.16	2.92
L	.425 BSC		10.8 BSC	
M	.852	.868	21.64	22.05
N	.851	.869	21.62	22.07
R	.395	.405	10.03	10.29
S	.394	.406	10.01	10.31
bbb	.010 REF		0.25 REF	
ccc	.015 REF		0.38 REF	

- STYLE 1:
- PIN 1. DRAIN
 2. DRAIN
 3. GATE
 4. GATE
 5. SOURCE

Motorola reserves the right to make changes without further notice to any products herein. Motorola makes no warranty, representation or guarantee regarding the suitability of its products for any particular purpose, nor does Motorola assume any liability arising out of the application or use of any product or circuit, and specifically disclaims any and all liability, including without limitation consequential or incidental damages. "Typical" parameters which may be provided in Motorola data sheets and/or specifications can and do vary in different applications and actual performance may vary over time. All operating parameters, including "Typicals" must be validated for each customer application by customer's technical experts. Motorola does not convey any license under its patent rights nor the rights of others. Motorola products are not designed, intended, or authorized for use as components in systems intended for surgical implant into the body, or other applications intended to support or sustain life, or for any other application in which the failure of the Motorola product could create a situation where personal injury or death may occur. Should Buyer purchase or use Motorola products for any such unintended or unauthorized application, Buyer shall indemnify and hold Motorola and its officers, employees, subsidiaries, affiliates, and distributors harmless against all claims, costs, damages, and expenses, and reasonable attorney fees arising out of, directly or indirectly, any claim of personal injury or death associated with such unintended or unauthorized use, even if such claim alleges that Motorola was negligent regarding the design or manufacture of the part. Motorola, Inc. Motorola, Inc. is an Equal Opportunity/Affirmative Action Employer. MOTOROLA and the  logo are registered in the US Patent & Trademark Office. All other product or service names are the property of their respective owners.

© Motorola, Inc. 2002.

How to reach us:

USA/EUROPE/Locations Not Listed: Motorola Literature Distribution; P.O. Box 5405, Denver, Colorado 80217. 1-303-675-2140 or 1-800-441-2447

JAPAN: Motorola Japan Ltd.; SPS, Technical Information Center, 3-20-1, Minami-Azabu. Minato-ku, Tokyo 106-8573 Japan. 81-3-3440-3569

ASIA/PACIFIC: Motorola Semiconductors H.K. Ltd.; Silicon Harbour Centre, 2 Dai King Street, Tai Po Industrial Estate, Tai Po, N.T., Hong Kong. 852-26668334

Technical Information Center: 1-800-521-6274

HOME PAGE: <http://www.motorola.com/semiconductors/>



This datasheet has been download from:

www.datasheetcatalog.com

Datasheets for electronics components.