

RF Power Field Effect Transistor

N-Channel Enhancement-Mode Lateral MOSFET

Designed for W-CDMA base station applications with frequencies from 2110 to 2170 MHz. Suitable for TDMA, CDMA and multicarrier amplifier applications. To be used in Class AB for PCN-PCS/cellular radio and WLL applications.

- Typical 2-Carrier W-CDMA Performance: $V_{DD} = 28$ Volts, $I_{DQ} = 1600$ mA, $P_{out} = 38$ Watts Avg., Channel Bandwidth = 3.84 MHz, PAR = 8.5 dB @ 0.01% Probability on CCDF.
Power Gain — 14 dB
Drain Efficiency — 25.5%
IM3 @ 10 MHz Offset — -37.5 dBc in 3.84 MHz Channel Bandwidth
ACPR @ 5 MHz Offset — -41 dBc in 3.84 MHz Channel Bandwidth
- Capable of Handling 10:1 VSWR, @ 28 Vdc, 2140 MHz, 180 Watts CW Output Power

Features

- Characterized with Series Equivalent Large-Signal Impedance Parameters
- Internally Matched for Ease of Use
- Qualified Up to a Maximum of 32 V_{DD} Operation
- Integrated ESD Protection
- Lower Thermal Resistance Package
- Low Gold Plating Thickness on Leads, 40 μ " Nominal.
- RoHS Compliant
- In Tape and Reel. R6 Suffix = 150 Units per 56 mm, 13 inch Reel.

MRF5P21180HR6

2110-2170 MHz, 38 W AVG., 28 V
2 x W-CDMA
LATERAL N-CHANNEL
RF POWER MOSFET

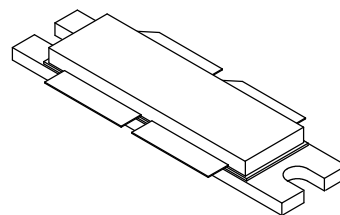

CASE 375D-05, STYLE 1
NI-1230

Table 1. Maximum Ratings

Rating	Symbol	Value	Unit
Drain-Source Voltage	V_{DSS}	-0.5, +65	Vdc
Gate-Source Voltage	V_{GS}	-0.5, +15	Vdc
Total Device Dissipation @ $T_C = 25^\circ\text{C}$ Derate above 25 $^\circ\text{C}$	P_D	530 3.0	W W/ $^\circ\text{C}$
Storage Temperature Range	T_{stg}	-65 to +150	$^\circ\text{C}$
Case Operating Temperature	T_C	150	$^\circ\text{C}$
Operating Junction Temperature	T_J	200	$^\circ\text{C}$

Table 2. Thermal Characteristics

Characteristic	Symbol	Value (1,2)	Unit
Thermal Resistance, Junction to Case Case Temperature 80 $^\circ\text{C}$, 180 W CW Case Temperature 71 $^\circ\text{C}$, 38 W CW	$R_{\theta JC}$	0.31 0.33	$^\circ\text{C}/\text{W}$

1. MTTF calculator available at <http://www.freescale.com/rf>. Select Software & Tools/Development Tools/Calculators to access MTTF calculators by product.
2. Refer to AN1955, *Thermal Measurement Methodology of RF Power Amplifiers*. Go to <http://www.freescale.com/rf>. Select Documentation/Application Notes - AN1955.

Table 3. ESD Protection Characteristics

Test Conditions	Class
Human Body Model	2 (Minimum)
Machine Model	M3 (Minimum)
Charge Device Model	C7 (Minimum)

Table 4. Electrical Characteristics ($T_C = 25^\circ\text{C}$ unless otherwise noted)

Characteristic	Symbol	Min	Typ	Max	Unit
Off Characteristics ⁽¹⁾					
Zero Gate Voltage Drain Leakage Current ($V_{DS} = 65\text{ Vdc}$, $V_{GS} = 0\text{ Vdc}$)	I_{DSS}	—	—	10	μA
Zero Gate Voltage Drain Leakage Current ($V_{DS} = 28\text{ Vdc}$, $V_{GS} = 0$)	I_{DSS}	—	—	1	μA
Gate-Source Leakage Current ($V_{GS} = 5\text{ Vdc}$, $V_{DS} = 0\text{ Vdc}$)	I_{GSS}	—	—	1	μA

On Characteristics

Gate Threshold Voltage ⁽¹⁾ ($V_{DS} = 10\text{ Vdc}$, $I_D = 200\ \mu\text{A}$)	$V_{GS(th)}$	2.5	2.8	3.5	Vdc
Gate Quiescent Voltage ⁽³⁾ ($V_{DS} = 28\text{ Vdc}$, $I_D = 1600\text{ mA}$)	$V_{GS(Q)}$	—	3.6	—	Vdc
Drain-Source On-Voltage ⁽¹⁾ ($V_{GS} = 10\text{ Vdc}$, $I_D = 2\text{ A}$)	$V_{DS(on)}$	—	0.26	0.3	Vdc
Forward Transconductance ⁽¹⁾ ($V_{DS} = 10\text{ Vdc}$, $I_D = 2\text{ A}$)	g_{fs}	—	5	—	S

Dynamic Characteristics ^(1,2)

Reverse Transfer Capacitance ($V_{DS} = 28\text{ Vdc} \pm 30\text{ mV(rms)}$ ac @ 1 MHz, $V_{GS} = 0\text{ Vdc}$)	C_{rss}	—	1.7	—	pF
--	-----------	---	-----	---	----

Functional Tests ⁽³⁾ (In Freescale Test Fixture, 50 ohm system) $V_{DD} = 28\text{ Vdc}$, $I_{DQ} = 1600\text{ mA}$, $P_{out} = 38\text{ W Avg.}$, $f = 2157.5\text{ MHz}$, 2-Carrier W-CDMA, 3.84 MHz Channel Bandwidth Carriers. ACPR measured in 3.84 MHz Channel Bandwidth @ $\pm 5\text{ MHz}$ Offset. IM3 measured in 3.84 MHz Bandwidth @ $\pm 10\text{ MHz}$ Offset. PAR = 8.5 dB @ 0.01% Probability on CCDF.

Power Gain	G_{ps}	12.5	14	—	dB
Drain Efficiency	η_D	23	25.5	—	%
Intermodulation Distortion	IM3	—	-37.5	-35	dBc
Adjacent Channel Power Ratio	ACPR	—	-41	-38	dBc
Input Return Loss	IRL	—	-14	-9	dB

- Each side of device measured separately.
- Part internally matched both on input and output.
- Measurement made with device in push-pull configuration.

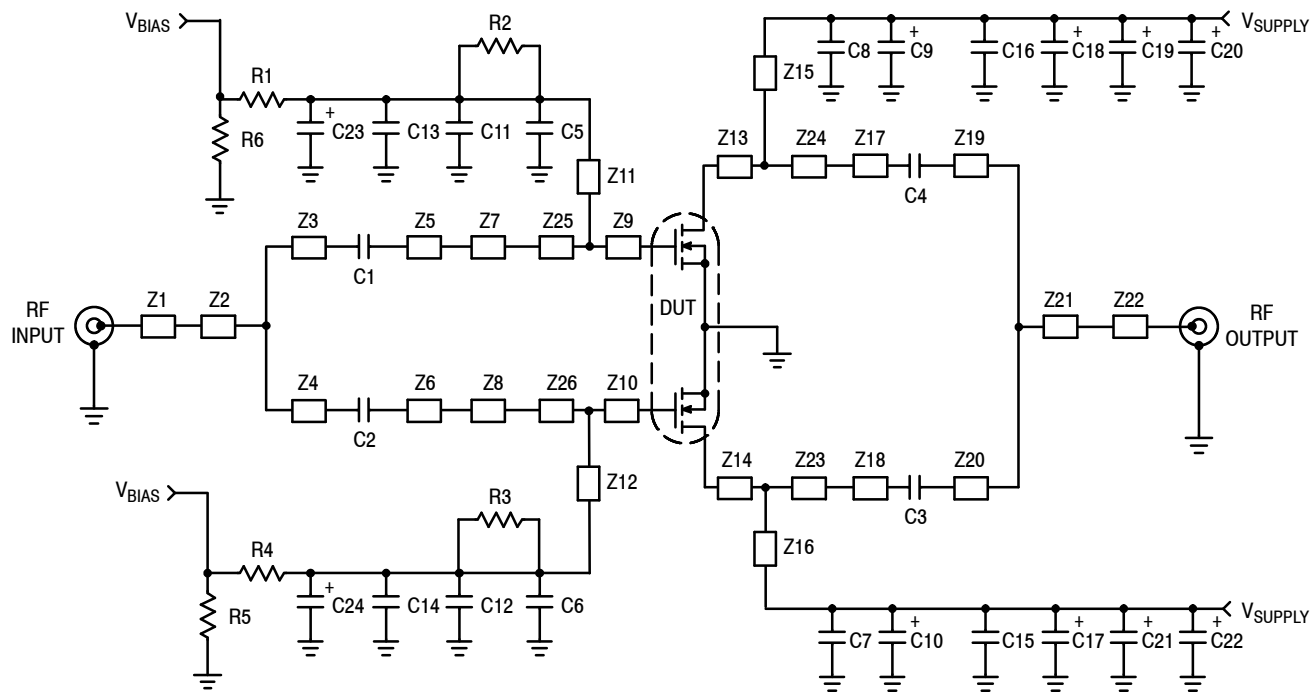

Z1, Z22	1.000" x 0.066" Microstrip	Z11, Z12	1.030" x 0.035" Microstrip
Z2, Z21	0.760" x 0.113" Microstrip	Z13, Z14	0.083" x 0.650" Microstrip
Z3, Z20	0.068" x 0.066" Microstrip	Z15, Z16	0.550" x 0.058" Microstrip
Z4, Z19	1.672" x 0.066" Microstrip	Z17, Z18	0.353" x 0.066" Microstrip
Z5, Z6	0.318" x 0.066" Microstrip	Z23, Z24	0.417" x 0.650" Microstrip
Z7, Z8	0.284" x 0.180" Microstrip	Z25, Z26	0.161" x 0.650" Microstrip
Z9, Z10	0.094" x 0.650" Microstrip	PCB	Taconic RF-35, 0.030", $\epsilon_r = 3.5$

Figure 1. MRF5P21180HR6 Test Circuit Schematic

Table 5. MRF5P21180HR6 Test Circuit Component Designations and Values

Part	Description	Part Number	Manufacturer
C1, C2, C3, C4	30 pF Chip Capacitors	ATC100B300JT500XT	ATC
C5, C6, C7, C8	5.6 pF Chip Capacitors	ATC100B5R6JT500XT	ATC
C9, C10	10 μ F Tantalum Capacitors	T495X106K035AT	Kemet
C11, C12	1000 pF Chip Capacitors	ATC100B102JT500XT	ATC
C13, C14, C15, C16	0.1 μ F Chip Capacitors	CDR33BX104AKYS	Kemet
C17, C18, C19, C20, C21, C22	22 μ F Tantalum Capacitors	T491X226K035AT	Kemet
C23, C24	1.0 μ F Tantalum Capacitors	T491C105M050AT	Kemet
R1, R2, R3, R4	10 Ω , 1/4 W Chip Resistors	CRCW120610R0FKEA	Vishay
R5, R6	1.0 k Ω , 1/4 W Chip Resistor	CRCW12061001FKEA	Vishay

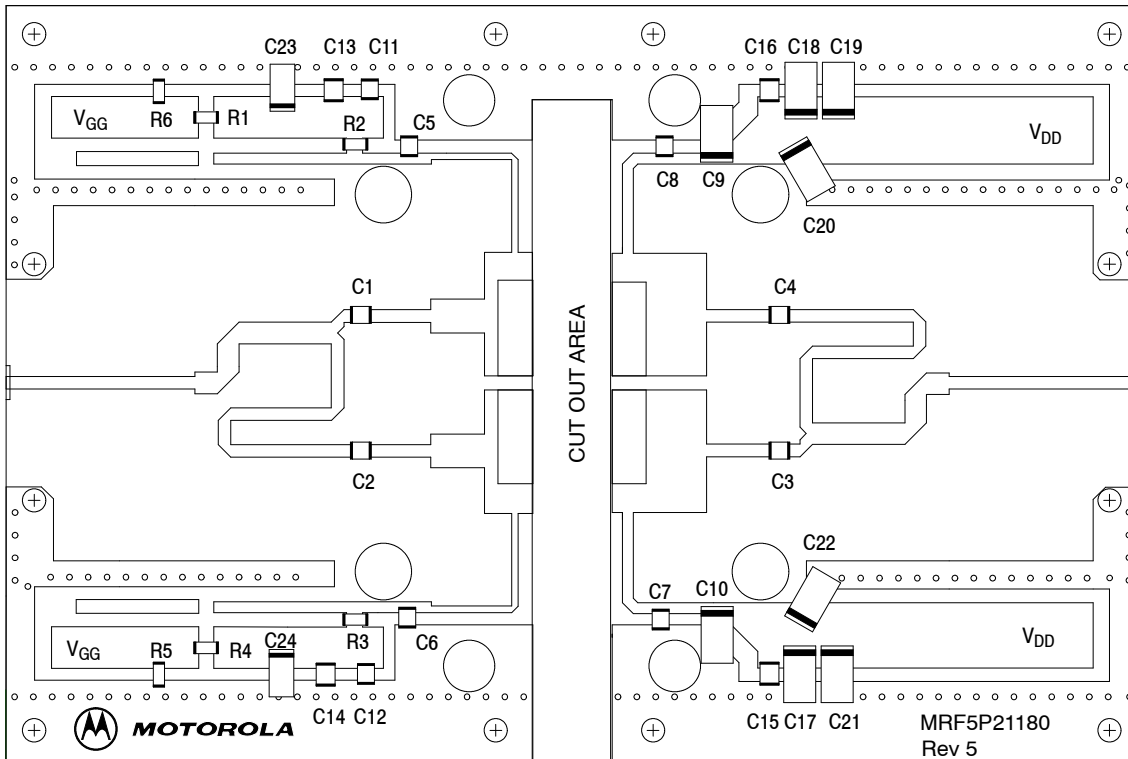

Freescal has begun the transition of marking Printed Circuit Boards (PCBs) with the Freescal Semiconductor signature/logo. PCBs may have either Motorola or Freescal markings during the transition period. These changes will have no impact on form, fit or function of the current product.

Figure 2. MRF5P21180HR6 Test Circuit Component Layout

TYPICAL CHARACTERISTICS

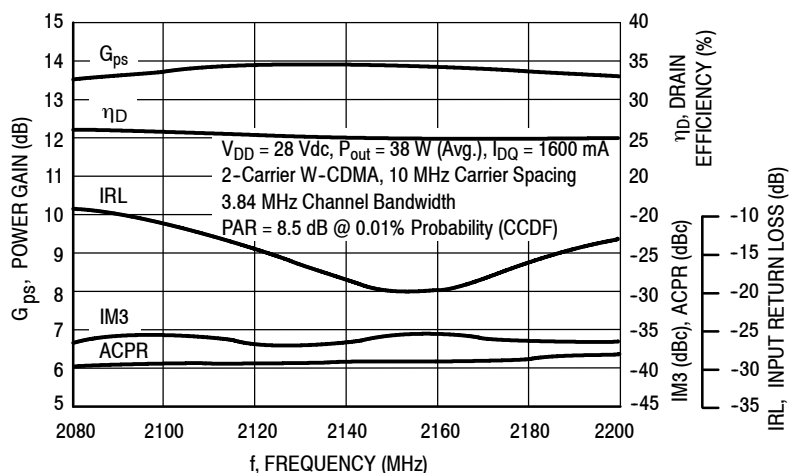

Figure 3. 2-Carrier W-CDMA Broadband Performance

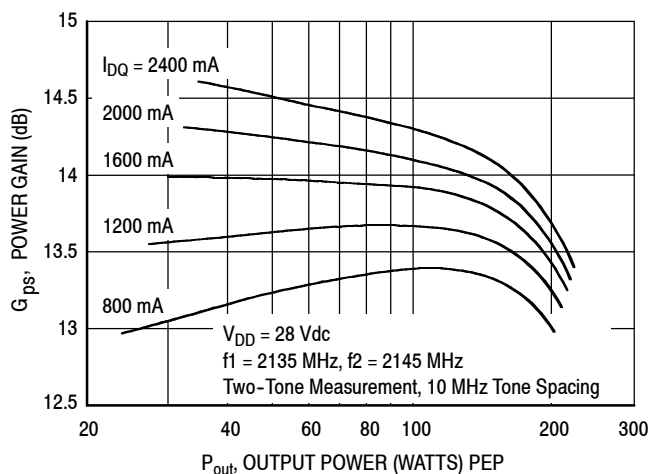

Figure 4. Two-Tone Power Gain versus Output Power

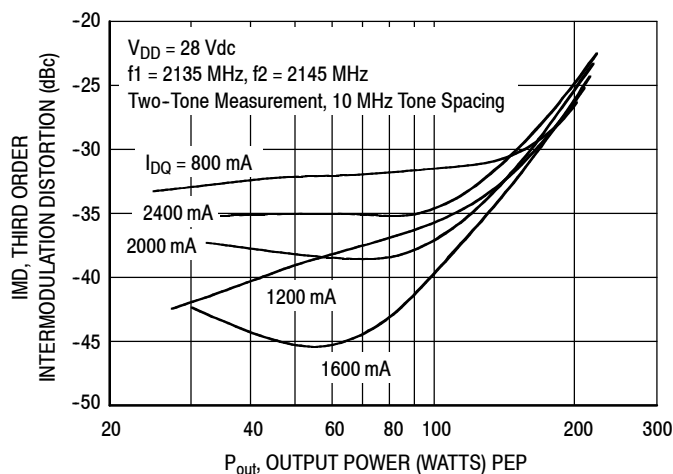

Figure 5. Third Order Intermodulation Distortion versus Output Power

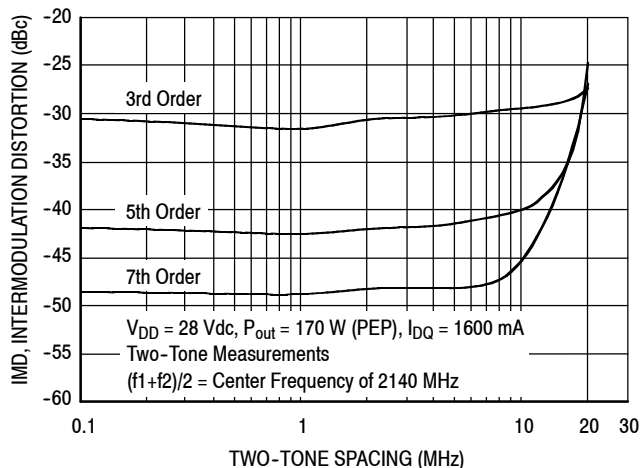

Figure 6. Intermodulation Distortion Products versus Tone Spacing

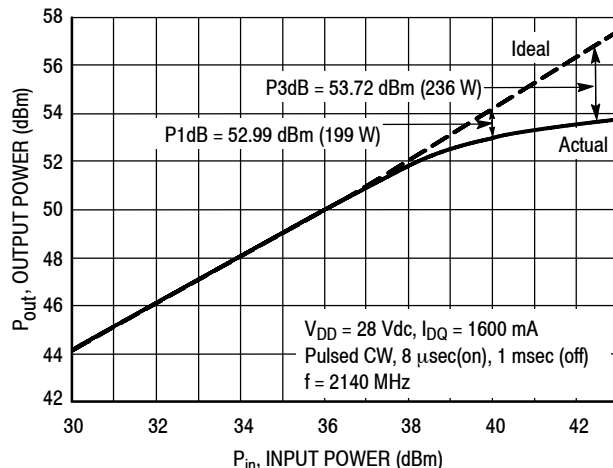

Figure 7. Pulse CW Output Power versus Input Power

TYPICAL CHARACTERISTICS

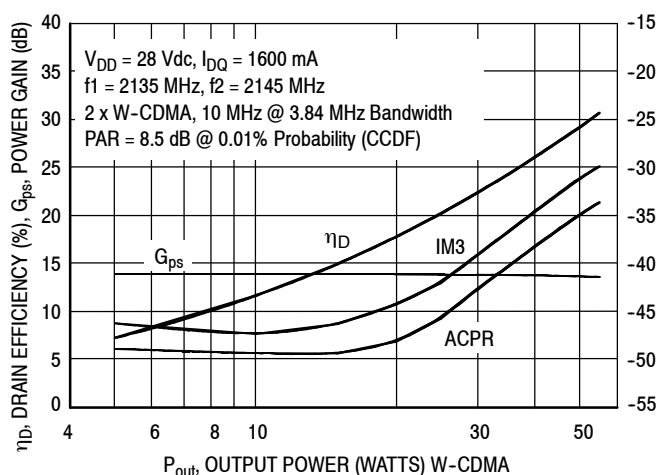
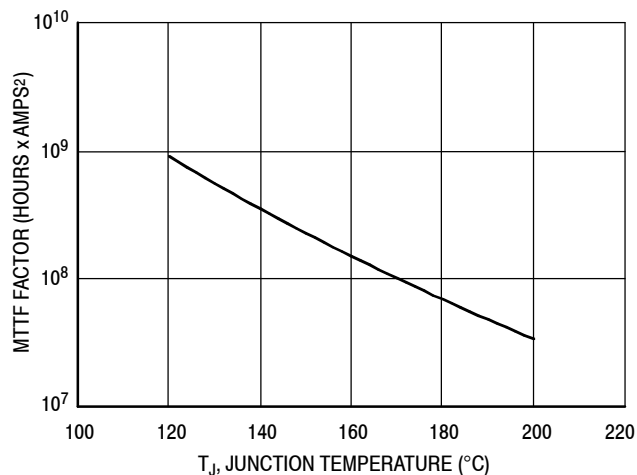

Figure 8. 2-Carrier W-CDMA ACPR, IM3, Power Gain and Drain Efficiency versus Output Power



This above graph displays calculated MTTF in hours x ampere² drain current. Life tests at elevated temperatures have correlated to better than $\pm 10\%$ of the theoretical prediction for metal failure. Divide MTTF factor by I_D^2 for MTTF in a particular application.

Figure 9. MTTF Factor versus Junction Temperature

W-CDMA TEST SIGNAL

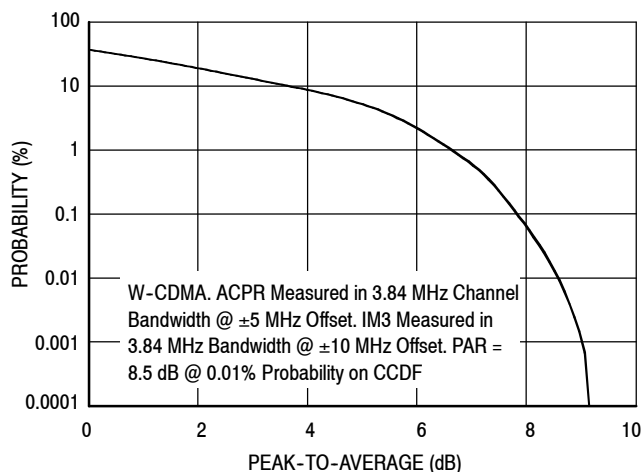

Figure 10. CCDF W-CDMA 3GPP, Test Model 1, 64 DPCH, 67% Clipping, Single Carrier Test Signal

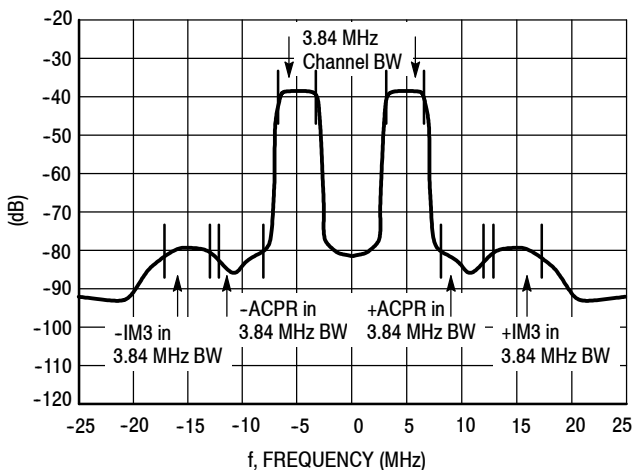
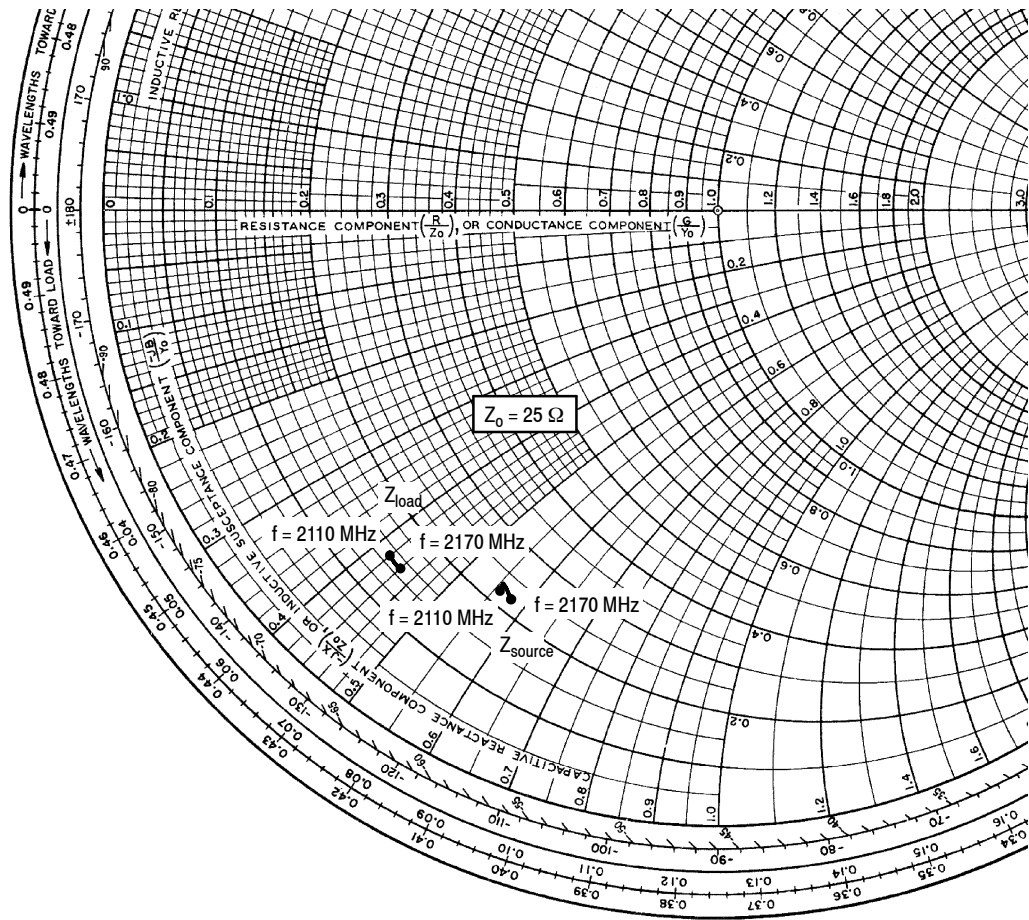

Figure 11. 2-Carrier W-CDMA Spectrum



$V_{DD} = 28 \text{ Vdc}$, $I_{DQ} = 1600 \text{ mA}$, $P_{out} = 38 \text{ W Avg.}$

f MHz	Z_{source} Ω	Z_{load} Ω
2110	$5.39 - j13.89$	$3.69 - j10.51$
2140	$5.66 - j13.99$	$3.81 - j10.66$
2170	$5.53 - j14.51$	$3.79 - j11.05$

Z_{source} = Test circuit impedance as measured from gate to gate, balanced configuration.

Z_{load} = Test circuit impedance as measured from drain to drain, balanced configuration.

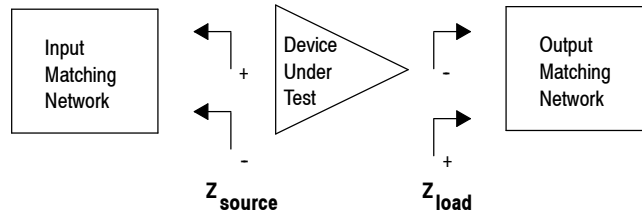
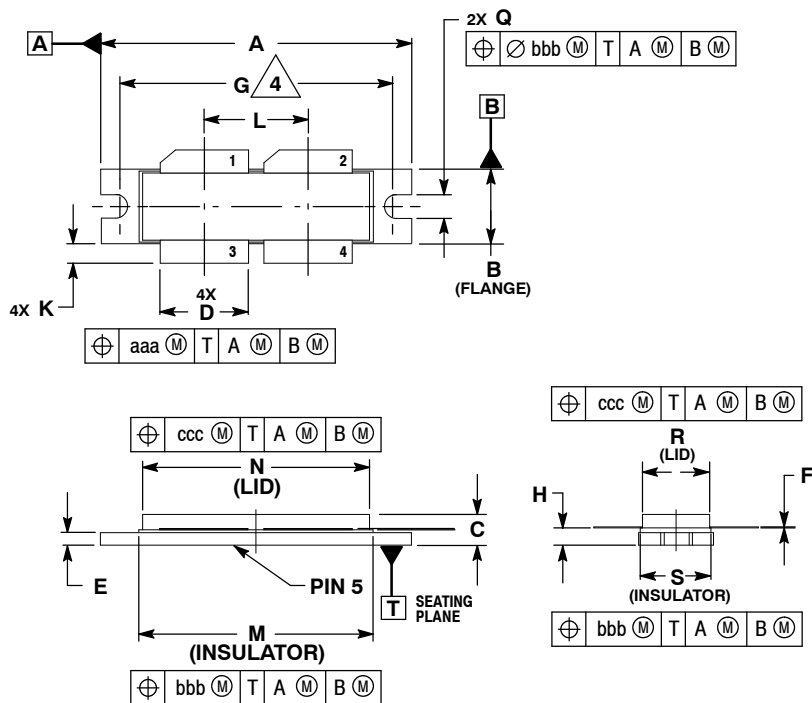

Figure 12. Series Equivalent Source and Load Impedance

PACKAGE DIMENSIONS



- NOTES:
1. INTERPRET DIMENSIONS AND TOLERANCES PER ASME Y14.5M-1994.
 2. CONTROLLING DIMENSION: INCH.
 3. DIMENSION H IS MEASURED 0.030 (0.762) AWAY FROM PACKAGE BODY.
 4. RECOMMENDED BOLT CENTER DIMENSION OF 1.52 (38.61) BASED ON M3 SCREW.

DIM	INCHES		MILLIMETERS	
	MIN	MAX	MIN	MAX
A	1.615	1.625	41.02	41.28
B	0.395	0.405	10.03	10.29
C	0.150	0.200	3.81	5.08
D	0.455	0.465	11.56	11.81
E	0.062	0.066	1.57	1.68
F	0.004	0.007	0.10	0.18
G	1.400 BSC		35.56 BSC	
H	0.082	0.090	2.08	2.29
K	0.117	0.137	2.97	3.48
L	0.540 BSC		13.72 BSC	
M	1.219	1.241	30.96	31.52
N	1.218	1.242	30.94	31.55
Q	0.120	0.130	3.05	3.30
R	0.355	0.365	9.01	9.27
S	0.365	0.375	9.27	9.53
aaa	0.013 REF		0.33 REF	
bbb	0.010 REF		0.25 REF	
ccc	0.020 REF		0.51 REF	

- STYLE 1:
- PIN 1. DRAIN
 - DRAIN
 - GATE
 - GATE
 - SOURCE

**CASE 375D-05
ISSUE E
NI-1230**

PRODUCT DOCUMENTATION

Refer to the following documents to aid your design process.

Application Notes

- AN1955: Thermal Measurement Methodology of RF Power Amplifiers

Engineering Bulletins

- EB212: Using Data Sheet Impedances for RF LDMOS Devices

REVISION HISTORY

The following table summarizes revisions to this document.

Revision	Date	Description
3	Oct. 2008	<ul style="list-style-type: none"> • Modified data sheet to reflect RF Test Reduction described in Product and Process Change Notification number, PCN12779, p. 1, 2 • Updated Part Numbers in Table 5, Component Designations and Values, to RoHS compliant part numbers, p. 3 • Added Product Documentation and Revision History, p. 9

How to Reach Us:

Home Page:

www.freescale.com

Web Support:

<http://www.freescale.com/support>

USA/Europe or Locations Not Listed:

Freescale Semiconductor, Inc.
Technical Information Center, EL516
2100 East Elliot Road
Tempe, Arizona 85284
1-800-521-6274 or +1-480-768-2130
www.freescale.com/support

Europe, Middle East, and Africa:

Freescale Halbleiter Deutschland GmbH
Technical Information Center
Schatzbogen 7
81829 Muenchen, Germany
+44 1296 380 456 (English)
+46 8 52200080 (English)
+49 89 92103 559 (German)
+33 1 69 35 48 48 (French)
www.freescale.com/support

Japan:

Freescale Semiconductor Japan Ltd.
Headquarters
ARCO Tower 15F
1-8-1, Shimo-Meguro, Meguro-ku,
Tokyo 153-0064
Japan
0120 191014 or +81 3 5437 9125
support.japan@freescale.com

Asia/Pacific:

Freescale Semiconductor China Ltd.
Exchange Building 23F
No. 118 Jianguo Road
Chaoyang District
Beijing 100022
China
+86 10 5879 8000
support.asia@freescale.com

For Literature Requests Only:

Freescale Semiconductor Literature Distribution Center
P.O. Box 5405
Denver, Colorado 80217
1-800-441-2447 or +1-303-675-2140
Fax: +1-303-675-2150
LDCForFreescaleSemiconductor@hibbertgroup.com

Information in this document is provided solely to enable system and software implementers to use Freescale Semiconductor products. There are no express or implied copyright licenses granted hereunder to design or fabricate any integrated circuits or integrated circuits based on the information in this document.

Freescale Semiconductor reserves the right to make changes without further notice to any products herein. Freescale Semiconductor makes no warranty, representation or guarantee regarding the suitability of its products for any particular purpose, nor does Freescale Semiconductor assume any liability arising out of the application or use of any product or circuit, and specifically disclaims any and all liability, including without limitation consequential or incidental damages. "Typical" parameters that may be provided in Freescale Semiconductor data sheets and/or specifications can and do vary in different applications and actual performance may vary over time. All operating parameters, including "Typicals", must be validated for each customer application by customer's technical experts. Freescale Semiconductor does not convey any license under its patent rights nor the rights of others. Freescale Semiconductor products are not designed, intended, or authorized for use as components in systems intended for surgical implant into the body, or other applications intended to support or sustain life, or for any other application in which the failure of the Freescale Semiconductor product could create a situation where personal injury or death may occur. Should Buyer purchase or use Freescale Semiconductor products for any such unintended or unauthorized application, Buyer shall indemnify and hold Freescale Semiconductor and its officers, employees, subsidiaries, affiliates, and distributors harmless against all claims, costs, damages, and expenses, and reasonable attorney fees arising out of, directly or indirectly, any claim of personal injury or death associated with such unintended or unauthorized use, even if such claim alleges that Freescale Semiconductor was negligent regarding the design or manufacture of the part.

Freescale™ and the Freescale logo are trademarks of Freescale Semiconductor, Inc. All other product or service names are the property of their respective owners.

© Freescale Semiconductor, Inc. 2008. All rights reserved.