

The RF Sub-Micron MOSFET Line  
**RF Power Field Effect Transistor**  
**N-Channel Enhancement-Mode Lateral MOSFET**

Designed for W-CDMA base station applications with frequencies from 2110 to 2170 MHz. Suitable for FM, TDMA, CDMA and multicarrier amplifier applications. To be used in Class AB for PCN-PCS/cellular radio and WLL applications.

- W-CDMA Performance @ -45 dBc, 5 MHz Offset, 15 DTCH, 1 Perch  
Output Power — 14 Watts (Avg.)  
Power Gain — 11.5 dB  
Efficiency — 16%
- Internally Matched, Controlled Q, for Ease of Use
- High Gain, High Efficiency and High Linearity
- Integrated ESD Protection
- Designed for Maximum Gain and Insertion Phase Flatness
- Capable of Handling 10:1 VSWR, @ 28 Vdc, 2170 MHz, 120 Watts (CW) Output Power
- Excellent Thermal Stability
- Characterized with Series Equivalent Large-Signal Impedance Parameters

**MRF21120**

**2170 MHz, 120 W, 28 V  
LATERAL N-CHANNEL  
RF POWER MOSFET**

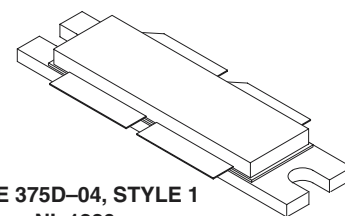

**CASE 375D-04, STYLE 1  
NI-1230**

**MAXIMUM RATINGS**

Rating	Symbol	Value	Unit
Drain-Source Voltage	$V_{DSS}$	65	Vdc
Gate-Source Voltage	$V_{GS}$	-0.5, +15	Vdc
Total Device Dissipation @ $T_C = 25^\circ\text{C}$ Derate above $25^\circ\text{C}$	$P_D$	389 2.22	Watts W/ $^\circ\text{C}$
Storage Temperature Range	$T_{stg}$	-65 to +150	$^\circ\text{C}$
Operating Junction Temperature	$T_J$	200	$^\circ\text{C}$

**ESD PROTECTION CHARACTERISTICS**

Test Conditions	Class
Human Body Model	1 (Minimum)
Machine Model	M3 (Minimum)

**THERMAL CHARACTERISTICS**

Characteristic	Symbol	Max	Unit
Thermal Resistance, Junction to Case	$R_{\theta JC}$	0.45	$^\circ\text{C}/\text{W}$

NOTE – **CAUTION** – MOS devices are susceptible to damage from electrostatic charge. Reasonable precautions in handling and packaging MOS devices should be observed.

**ELECTRICAL CHARACTERISTICS** ( $T_C = 25^\circ\text{C}$  unless otherwise noted)

Characteristic	Symbol	Min	Typ	Max	Unit
<b>OFF CHARACTERISTICS (1)</b>					
Drain–Source Breakdown Voltage ( $V_{GS} = 0 \text{ Vdc}$ , $I_D = 20 \mu\text{Adc}$ )	$V_{(BR)DSS}$	65	—	—	Vdc
Gate–Source Leakage Current ( $V_{GS} = 5 \text{ Vdc}$ , $V_{DS} = 0 \text{ Vdc}$ )	$I_{GSS}$	—	—	1	$\mu\text{Adc}$
Zero Gate Voltage Drain Leakage Current ( $V_{DS} = 28 \text{ Vdc}$ , $V_{GS} = 0 \text{ Vdc}$ )	$I_{DSS}$	—	—	10	$\mu\text{Adc}$
<b>ON CHARACTERISTICS (1)</b>					
Forward Transconductance ( $V_{DS} = 10 \text{ Vdc}$ , $I_D = 2 \text{ Adc}$ )	$g_{fs}$	—	4.8	—	S
Gate Threshold Voltage ( $V_{DS} = 10 \text{ V}$ , $I_D = 200 \mu\text{A}$ )	$V_{GS(th)}$	2.5	3	3.8	Vdc
Gate Quiescent Voltage ( $V_{DS} = 28 \text{ V}$ , $I_D = 500 \text{ mA}$ )	$V_{GS(Q)}$	3	3.9	5	Vdc
Drain–Source On–Voltage ( $V_{GS} = 10 \text{ V}$ , $I_D = 2 \text{ A}$ )	$V_{DS(on)}$	—	0.38	0.5	Vdc
<b>DYNAMIC CHARACTERISTICS (1)</b>					
Reverse Transfer Capacitance ( $V_{DS} = 28 \text{ Vdc}$ , $V_{GS} = 0$ , $f = 1 \text{ MHz}$ )	$C_{rss}$	—	2.8	—	pF
<b>FUNCTIONAL TESTS (In Motorola Test Fixture, 50 ohm system) (2)</b>					
Common–Source Amplifier Power Gain ( $V_{DD} = 28 \text{ Vdc}$ , $P_{out} = 120 \text{ W PEP}$ , $I_{DQ} = 2 \times 500 \text{ mA}$ , $f_1 = 2170.0 \text{ MHz}$ , $f_2 = 2170.1 \text{ MHz}$ )	$G_{ps}$	10.5	11.4	—	dB
Drain Efficiency ( $V_{DD} = 28 \text{ Vdc}$ , $P_{out} = 120 \text{ W PEP}$ , $I_{DQ} = 2 \times 500 \text{ mA}$ , $f_1 = 2170.0 \text{ MHz}$ , $f_2 = 2170.1 \text{ MHz}$ )	$\eta$	30	34.5	—	%
Intermodulation Distortion ( $V_{DD} = 28 \text{ Vdc}$ , $P_{out} = 120 \text{ W PEP}$ , $I_{DQ} = 2 \times 500 \text{ mA}$ , $f_1 = 2170.0 \text{ MHz}$ , $f_2 = 2170.1 \text{ MHz}$ )	IMD	—	–31	–28	dB
Input Return Loss ( $V_{DD} = 28 \text{ Vdc}$ , $P_{out} = 120 \text{ W PEP}$ , $I_{DQ} = 2 \times 500 \text{ mA}$ , $f_1 = 2170.0 \text{ MHz}$ , $f_2 = 2170.1 \text{ MHz}$ )	IRL	—	–12	–9	dB
Common–Source Amplifier Power Gain ( $V_{DD} = 28 \text{ Vdc}$ , $P_{out} = 120 \text{ W PEP}$ , $I_{DQ} = 2 \times 500 \text{ mA}$ , $f_1 = 2140.0 \text{ MHz}$ , $f_2 = 2140.1 \text{ MHz}$ )	$G_{ps}$	—	11.5	—	dB
Common–Source Amplifier Power Gain ( $V_{DD} = 28 \text{ Vdc}$ , $P_{out} = 120 \text{ W PEP}$ , $I_{DQ} = 2 \times 500 \text{ mA}$ , $f_1 = 2110.0 \text{ MHz}$ , $f_2 = 2110.1 \text{ MHz}$ )	$G_{ps}$	—	11.5	—	dB
Drain Efficiency ( $V_{DD} = 28 \text{ Vdc}$ , $P_{out} = 120 \text{ W PEP}$ , $I_{DQ} = 2 \times 500 \text{ mA}$ , $f_1 = 2110.0 \text{ MHz}$ , $f_2 = 2110.1 \text{ MHz}$ )	$\eta$	—	34.5	—	%
Intermodulation Distortion ( $V_{DD} = 28 \text{ Vdc}$ , $P_{out} = 120 \text{ W PEP}$ , $I_{DQ} = 2 \times 500 \text{ mA}$ , $f_1 = 2110.0 \text{ MHz}$ , $f_2 = 2110.1 \text{ MHz}$ )	IMD	—	–31	—	dB
Input Return Loss ( $V_{DD} = 28 \text{ Vdc}$ , $P_{out} = 120 \text{ W PEP}$ , $I_{DQ} = 2 \times 500 \text{ mA}$ , $f_1 = 2110.0 \text{ MHz}$ , $f_2 = 2110.1 \text{ MHz}$ )	IRL	—	–12	—	dB
Power Output, 1 dB Compression Point ( $V_{DD} = 28 \text{ Vdc}$ , CW, $I_{DQ} = 2 \times 500 \text{ mA}$ , $f_1 = 2170.0 \text{ MHz}$ )	P1dB	—	120	—	Watts

(1) Each side of device measured separately.

(2) Device measured in push–pull configuration.

**ELECTRICAL CHARACTERISTICS — continued** ( $T_C = 25^\circ\text{C}$  unless otherwise noted)

Characteristic	Symbol	Min	Typ	Max	Unit
<b>FUNCTIONAL TESTS</b> (In Motorola Test Fixture, 50 ohm system) (2) (continued)					
Common–Source Amplifier Power Gain ( $V_{DD} = 28\text{ Vdc}$ , $P_{out} = 120\text{ W CW}$ , $I_{DQ} = 2 \times 500\text{ mA}$ , $f_1 = 2170.0\text{ MHz}$ )	$G_{ps}$	—	10.5	—	dB
Drain Efficiency ( $V_{DD} = 28\text{ Vdc}$ , $P_{out} = 120\text{ W CW}$ , $I_{DQ} = 2 \times 500\text{ mA}$ , $f_1 = 2170.0\text{ MHz}$ )	$\eta$	—	42	—	%
Output Mismatch Stress ( $V_{DD} = 28\text{ Vdc}$ , $P_{out} = 120\text{ W CW}$ , $I_{DQ} = 2 \times 500\text{ mA}$ , $f = 2.17\text{ GHz}$ , $VSWR = 10:1$ , All Phase Angles at Frequency of Tests)	$\Psi$	No Degradation In Output Power Before and After Test			

(2) Device measured in push–pull configuration.

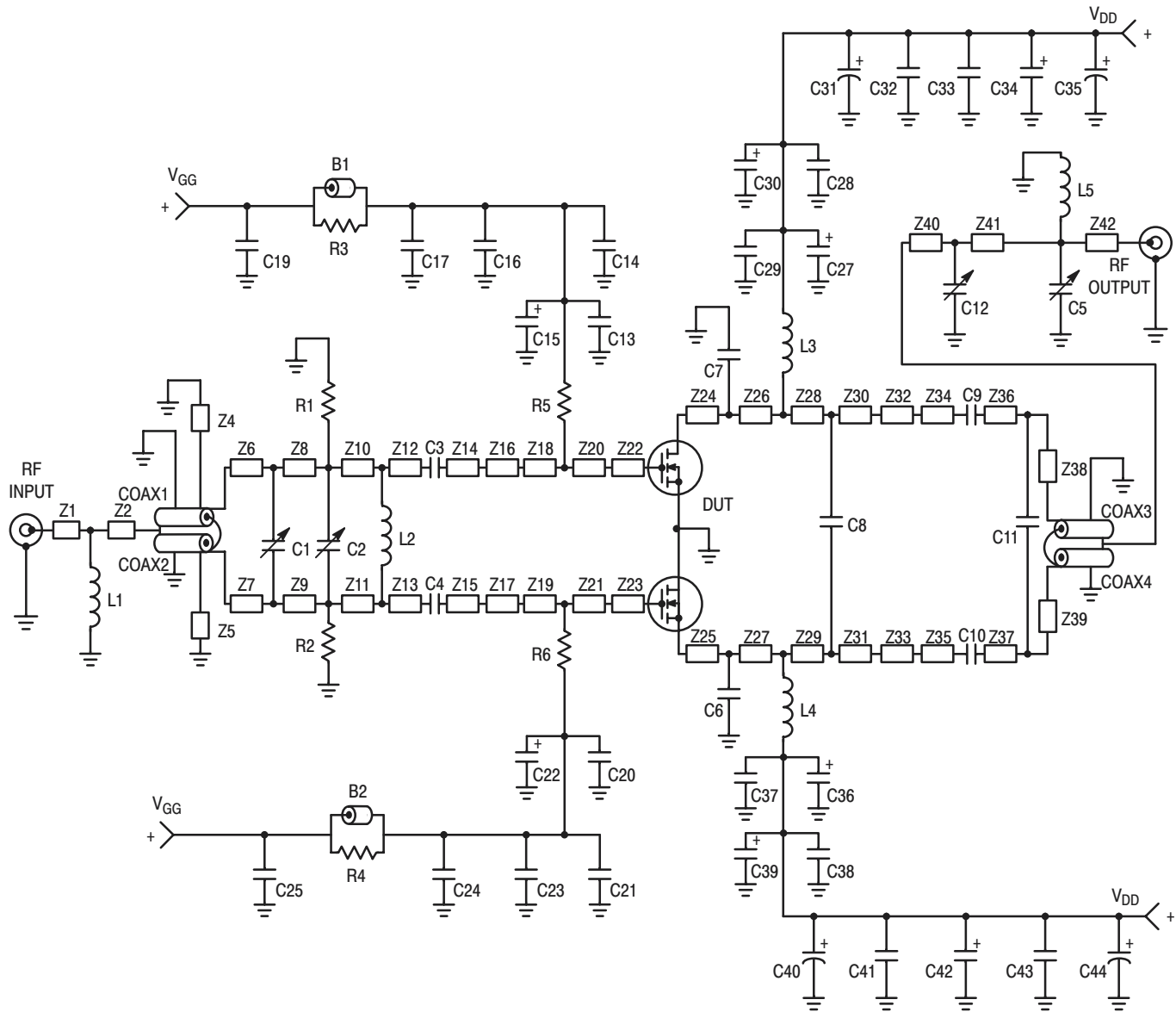

B1, B2	Ferrite Beads, Fair Rite	Z2	0.320" x 0.080" Microstrip
C1, C2, C12	0.6 – 4.5 pF Variable Capacitors, Johanson Gigatrim	Z4, Z5	1.050" x 0.080" Microstrip
C3, C4, C9, C10	10 pF Chip Capacitors, B Case, ATC	Z6, Z7	0.120" x 0.080" Microstrip
C5	0.4 – 2.5 pF Variable Capacitor, Johanson Gigatrim	Z8, Z9	0.140" x 0.080" Microstrip
C6, C7	2.0 pF Chip Capacitors, B Case, ATC	Z10, Z11	0.610" x 0.080" Microstrip
C8	0.5 pF Chip Capacitor, B Case, ATC	Z12, Z13	0.135" x 0.080" Microstrip
C11	0.2 pF Chip Capacitor, B Case, ATC	Z14, Z15	0.130" x 0.080" Microstrip
C13, C20, C29, C37	5.1 pF Chip Capacitors, B Case, ATC	Z16, Z17	0.300" x 0.350" Microstrip
C14, C21, C28, C38	91 pF Chip Capacitors, B Case, ATC	Z18, Z19	0.150" x 0.500" Microstrip
C15, C22, C27, C34, C36, C42	22 $\mu$ F, 35 V Tantalum Surface Mount Chip Capacitors, Kemet	Z20, Z21	0.075" x 0.500" Microstrip
C16, C23, C33, C43	0.039 $\mu$ F Chip Capacitors, B Case, ATC	Z22, Z23	0.330" x 0.500" Microstrip
C17, C24, C32, C41	1000 pF Chip Capacitors, B Case, ATC	Z24, Z25	0.100" x 0.550" Microstrip
C19, C25	0.022 $\mu$ F Chip Capacitors, B Case, ATC	Z26, Z27	0.175" x 0.550" Microstrip
C30, C39	1.0 $\mu$ F, 35 V Tantalum Surface Mount Chip Capacitors, Kemet	Z28, Z29	0.045" x 0.550" Microstrip
C31, C40	100 $\mu$ F, 50 V Electrolytic Capacitors, Sprague	Z30, Z31	0.190" x 0.325" Microstrip
C35, C44	470 $\mu$ F, 63 V Electrolytic Capacitors, Sprague	Z32, Z33	0.080" x 0.325" Microstrip
Coax1, Coax2	25 $\Omega$ Semi Rigid Coax, 70 mil OD, 1.05" Long	Z34, Z35	0.515" x 0.080" Microstrip
Coax3, Coax4	50 $\Omega$ Semi Rigid Coax, 85 mil OD, 1.05" Long	Z36, Z37	0.020" x 0.080" Microstrip
L1, L5	5.0 nH Minispring Inductors, Coilcraft	Z38, Z39	0.565" x 0.080" Microstrip
L2	8.0 nH Minispring Inductor, Coilcraft	Z40	0.100" x 0.080" Microstrip
L3, L4	7.15 nH Minispring Inductors, Coilcraft	Z41	0.470" x 0.080" Microstrip
R1, R2	1 k $\Omega$ , 1/4 W Fixed Metal Film Resistors, Dale	Z42	0.100" x 0.080" Microstrip
R3, R4	270 $\Omega$ , 1/8 W Fixed Film Chip Resistors, Dale	Board Material	0.03" Teflon <sup>®</sup> , $\epsilon_r = 2.55$ Copper Clad, 2 oz. Cu
R5, R6	1.2 k $\Omega$ , 1/8 W Fixed Film Chip Resistors, Dale	Connectors	N-Type Panel Mount, Stripline
Z1	0.150" x 0.080" Microstrip		

Figure 1. 2.1 – 2.2 GHz Broadband Test Circuit Schematic

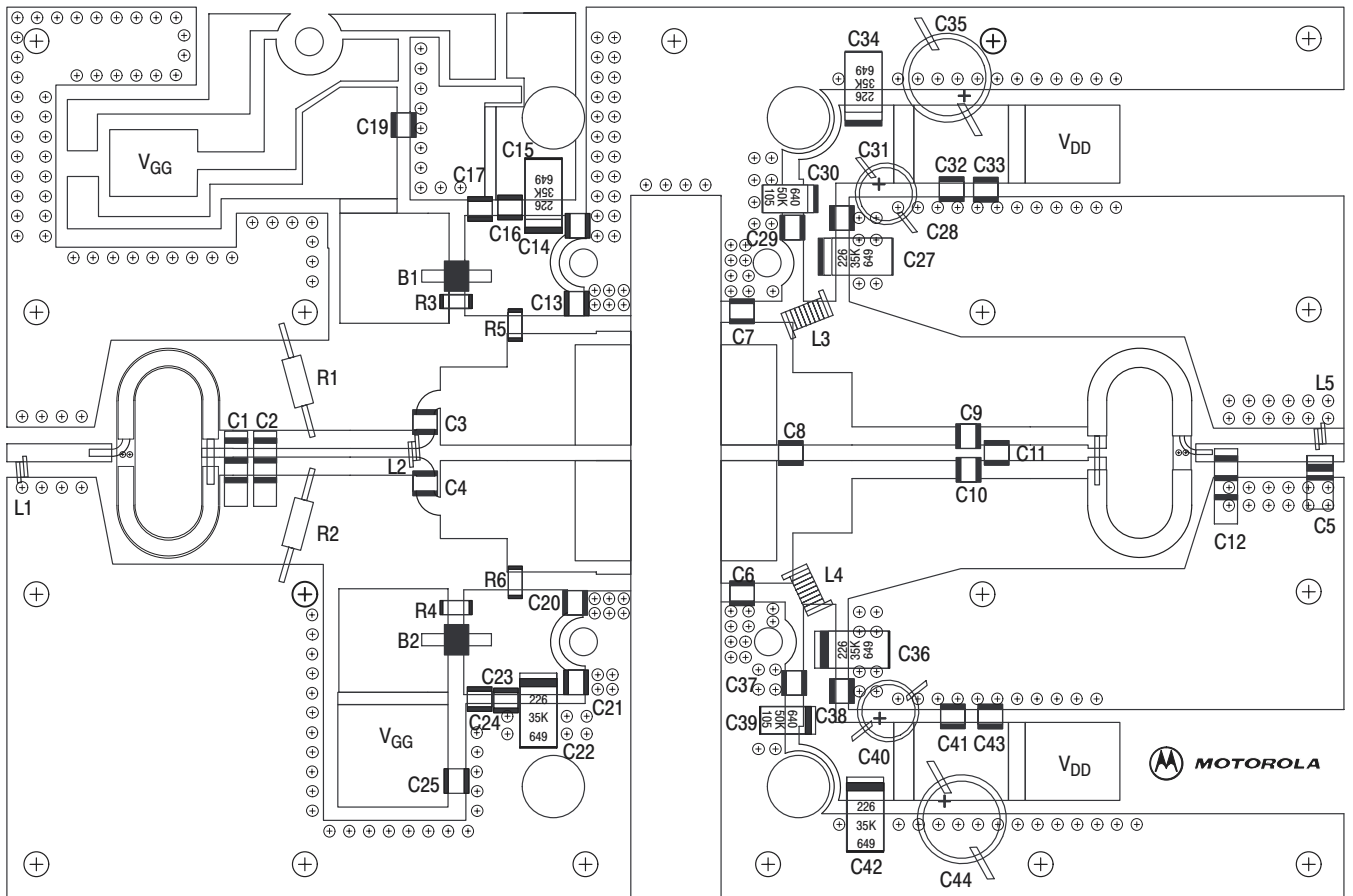
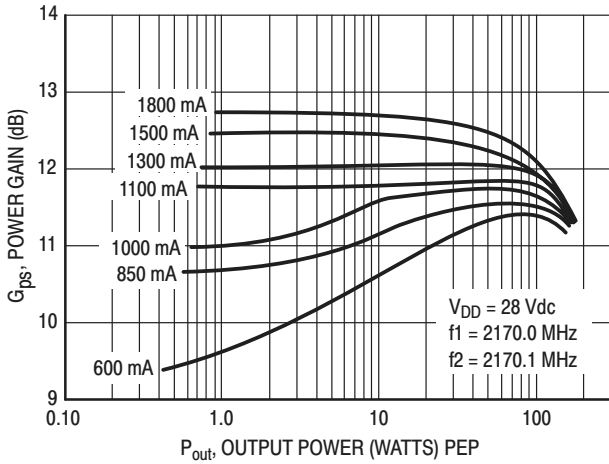
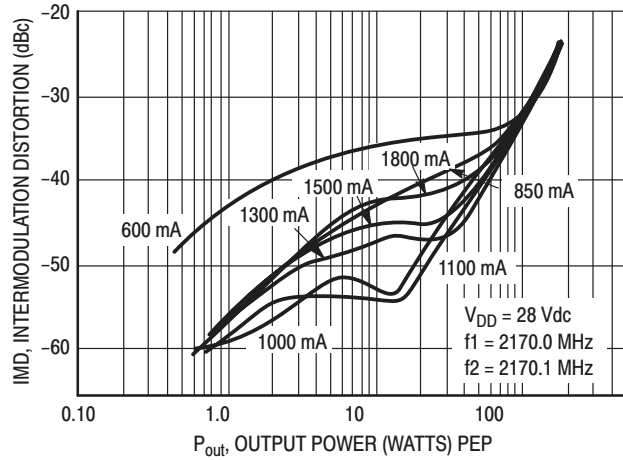

Figure 2. 2.1 – 2.2 GHz Broadband Test Circuit Component Layout

## TYPICAL CHARACTERISTICS



**Figure 3. Power Gain versus Output Power**



**Figure 4. Intermodulation Distortion versus Output Power**

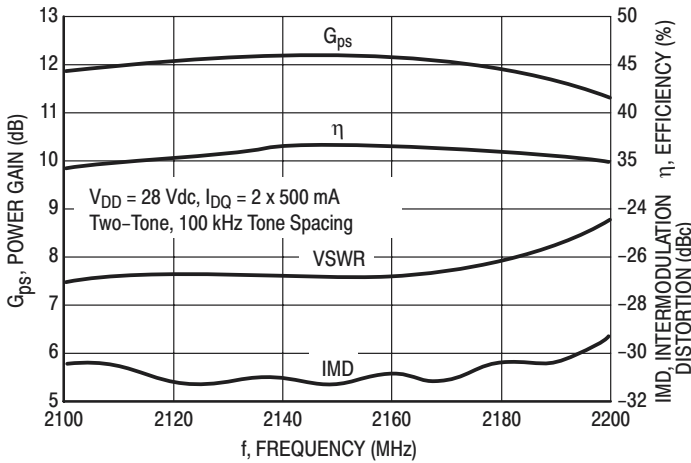

**Figure 5. Class AB Broadband Circuit Performance**

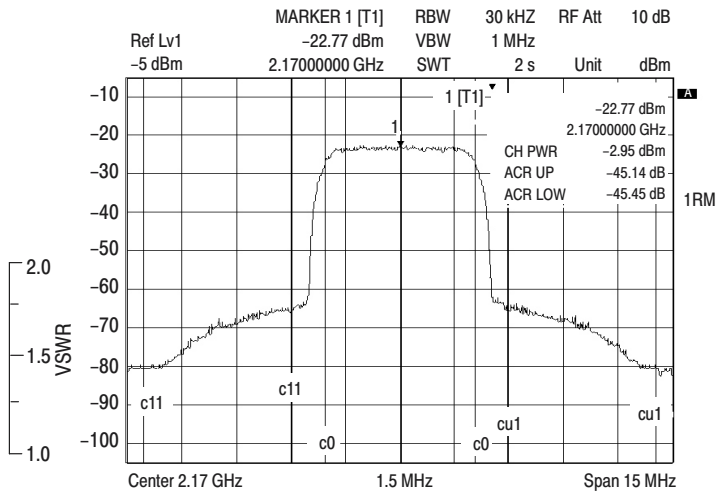

**Figure 6. 2.17 GHz W-CDMA Mask at 14 Watts (Avg.), 5 MHz Offset, 15 DTCH, 1 Perch**

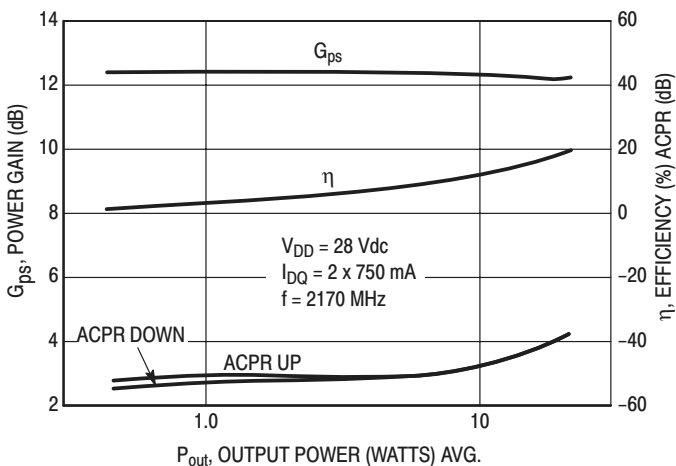

**Figure 7. Power Gain, Efficiency, ACPR versus Output Power (W-CDMA)**

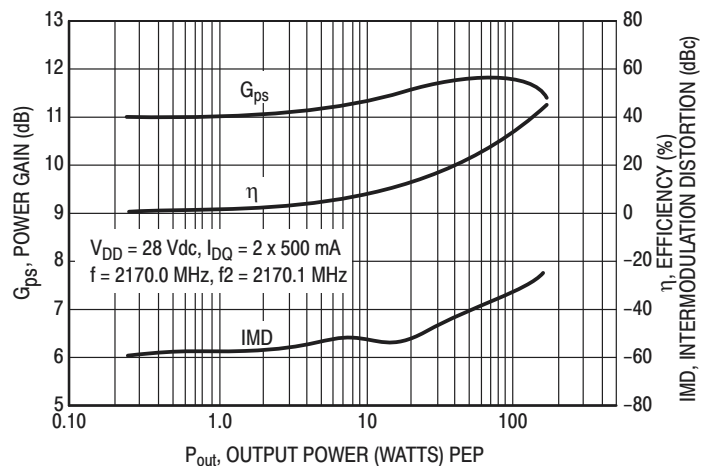

**Figure 8. Power Gain, Efficiency, IMD versus Output Power**

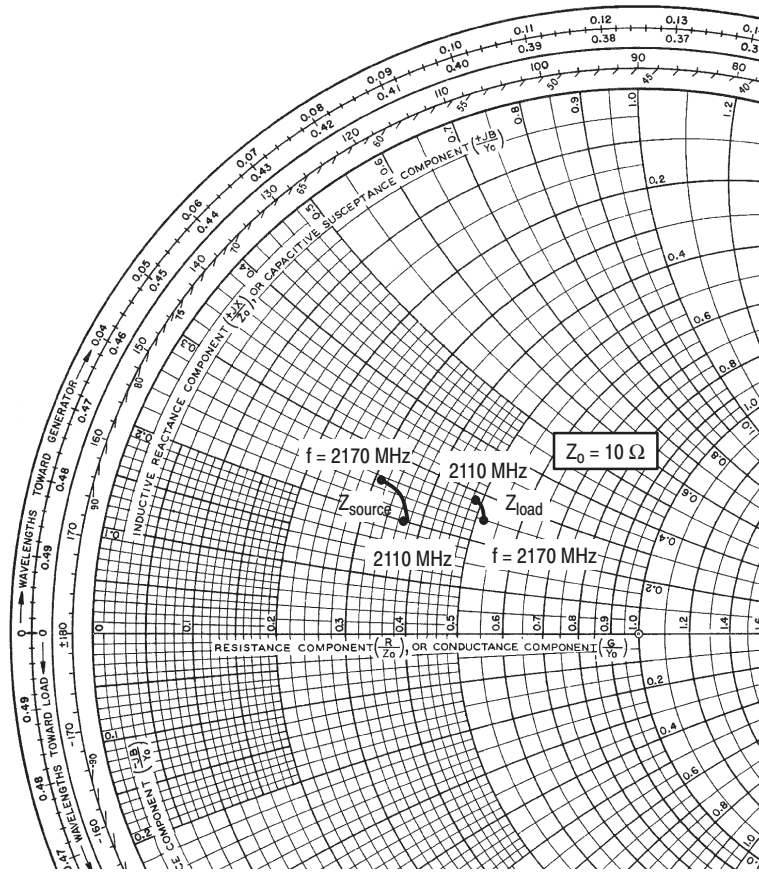

$V_{DD} = 28\text{ V}$ ,  $I_{DQ} = 2 \times 500\text{ mA}$ ,  $P_{out} = 120\text{ W PEP}$

f MHz	$Z_{source}$ $\Omega$	$Z_{load}$ $\Omega$
2110	$3.7 + j2.0$	$4.9 + j2.8$
2140	$3.5 + j2.4$	$5.1 + j2.7$
2170	$3.1 + j2.5$	$5.2 + j2.5$

$Z_{source}$  = Test circuit impedance as measured from gate to gate, balanced configuration.

$Z_{load}$  = Test circuit impedance as measured from drain to drain, balanced configuration.

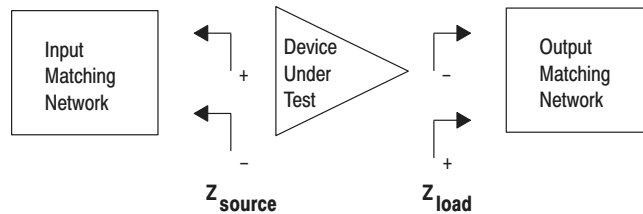
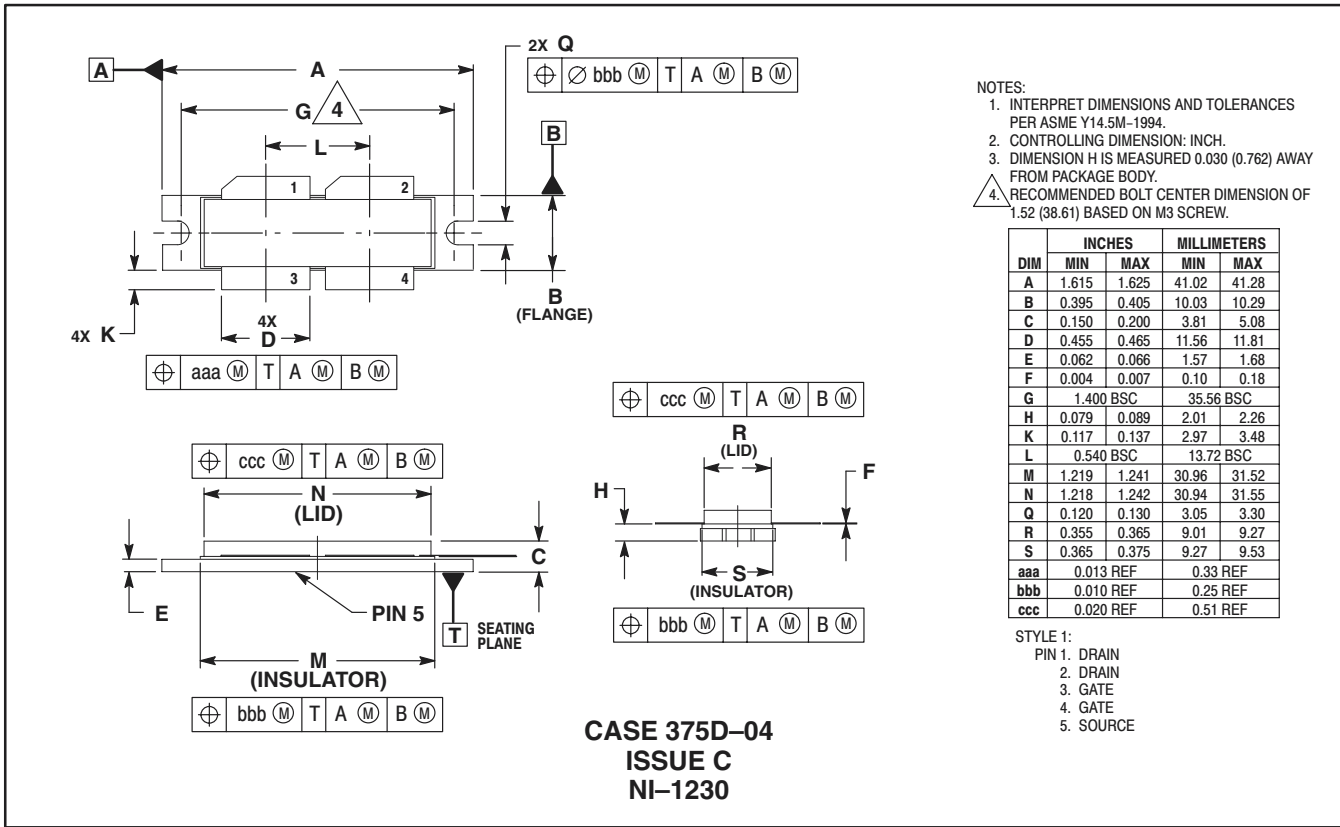



Figure 9. Series Equivalent Input and Output Impedance

## PACKAGE DIMENSIONS



Motorola reserves the right to make changes without further notice to any products herein. Motorola makes no warranty, representation or guarantee regarding the suitability of its products for any particular purpose, nor does Motorola assume any liability arising out of the application or use of any product or circuit, and specifically disclaims any and all liability, including without limitation consequential or incidental damages. "Typical" parameters which may be provided in Motorola data sheets and/or specifications can and do vary in different applications and actual performance may vary over time. All operating parameters, including "Typicals" must be validated for each customer application by customer's technical experts. Motorola does not convey any license under its patent rights nor the rights of others. Motorola products are not designed, intended, or authorized for use as components in systems intended for surgical implant into the body, or other applications intended to support or sustain life, or for any other application in which the failure of the Motorola product could create a situation where personal injury or death may occur. Should Buyer purchase or use Motorola products for any such unintended or unauthorized application, Buyer shall indemnify and hold Motorola and its officers, employees, subsidiaries, affiliates, and distributors harmless against all claims, costs, damages, and expenses, and reasonable attorney fees arising out of, directly or indirectly, any claim of personal injury or death associated with such unintended or unauthorized use, even if such claim alleges that Motorola was negligent regarding the design or manufacture of the part. Motorola, Inc. Motorola, Inc. is an Equal Opportunity/Affirmative Action Employer. MOTOROLA and the  logo are registered in the US Patent & Trademark Office. All other product or service names are the property of their respective owners.

© Motorola, Inc. 2002.

**How to reach us:**

**USA/EUROPE/Locations Not Listed:** Motorola Literature Distribution; P.O. Box 5405, Denver, Colorado 80217. 1-303-675-2140 or 1-800-441-2447

**JAPAN:** Motorola Japan Ltd.; SPS, Technical Information Center, 3-20-1, Minami-Azabu, Minato-ku, Tokyo 106-8573 Japan. 81-3-3440-3569

**ASIA/PACIFIC:** Motorola Semiconductors H.K. Ltd.; Silicon Harbour Centre, 2 Dai King Street, Tai Po Industrial Estate, Tai Po, N.T. Hong Kong. 852-26668334

**Technical Information Center: 1-800-521-6274**

**HOME PAGE:** <http://www.motorola.com/semiconductors/>





This datasheet has been download from:

[www.datasheetcatalog.com](http://www.datasheetcatalog.com)

Datasheets for electronics components.