

AH102A

Medium Power, High Linearity Amplifier



Product Features

- 350 – 3000 MHz
- +46 dBm Output IP3
- 14.5 dB Gain
- +27 dBm P1dB
- MTTF > 1000 Years
- Internally Matched
- Single +9 V Supply
- Lead-free/Green/RoHS-compliant SOT-89 Package

Applications

- Mobile Infrastructure
- W-LAN / ISM / WLL / RFID
- Broadband Wireless
- PowerAmp Predistortion Circuitry

Product Description

The AH102A is a medium power gain block that offers excellent dynamic range in a low-cost surface mount package. The combination of a single supply voltage and an internally matched device makes it ideal for both narrow and broadband applications.

Superior thermal design allows the product to achieve +46 dBm IP3 performances at a mounting temperature of +85 °C with an associated MTTF of greater than 1000 years. The AH102A is available in the environmentally-friendly lead-free/green/RoHS-compliant SOT-89 package.

The broadband amplifier uses a high reliability GaAs MESFET technology and is targeted for applications where high linearity is required. It is well suited for various current and next generation wireless technologies such as GPRS, GSM, CDMA, and W-CDMA. In addition, the AH102A will work for other applications within the 250 to 3000 MHz frequency range such as broadband wireless.

Functional Diagram

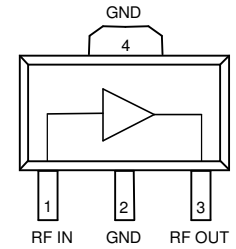

Function	Pin No.
Input	1
Ground	2
Output / Bias	3
Ground	4

Specifications ⁽¹⁾

Parameter	Units	Min	Typ	Max
Operational Bandwidth	MHz	350		3000
Test Frequency	MHz		800	
Gain	dB	12.5	14.4	
Output IP3 ⁽²⁾	dBm	+43	+46	
Output P1dB	dBm		+27	
Noise Figure	dB		3.1	
Test Frequency	MHz		1900	
Gain	dB	11.5	13	
Output IP3 ⁽²⁾	dBm	+42	+44.5	
Output P1dB	dBm		+27	
Operating Current Range	mA		200	230
Supply Voltage	V		+9	

1. Test conditions unless otherwise noted: T = 25 °C, V_{dd} = +9 V in a 50 ohm test fixture.
 2. OIP3 is measured with two tones at an output power of +8 dBm/tone separated by 10 MHz. The suppression on the largest IM3 product is used to calculate the OIP3 using a 2:1 rule.

Typical Performance ⁽³⁾

Parameter	Units	Typical		
Frequency	MHz	900	1900	2140
Gain	dB	14.5	13.6	13.5
Input Return Loss	dB	22	16	19
Output Return Loss	dB	30	15	15
Output P1dB	dBm	+27	+27	+27
Output IP3 ⁽²⁾	dBm	+46	+45	+44
IS-95A Channel Power @ -45 dBc ACPR	dBm	+21	+20	
W-CDMA Channel Power @ -45 dBc ACLR	dBm			+18.2
Noise Figure	dB	3.1	3.8	3.7
Supply Current	mA		200	
Supply Voltage	V		+9	

3. Parameters reflect performance in a tuned application circuit.

Absolute Maximum Rating

Parameter	Rating
Storage Temperature	-55 to +150 °C
DC Voltage	+11 V
RF Input Power (continuous)	+17 dBm
Junction Temperature	160 °C
Thermal Resistance, R _{th}	25 °C / W

Operation of this device above any of these parameters may cause permanent damage.

Ordering Information

Part No.	Description
AH102A-G	Medium Power, High Linearity Amplifier (lead-free/green/RoHS-compliant SOT-89 package)
AH102A-PCB900	900 MHz Fully Assembled Evaluation Board
AH102A-PCB2000	1.7-2.2 GHz Fully Assembled Evaluation Board

Standard T/R size = 1000 pieces on a 7" reel.

Typical Device Data

$V_{DS} = +9\text{ V}$, $I_{DS} = 200\text{ mA}$, $T = 25\text{ }^{\circ}\text{C}$, unmatched 50 ohm system

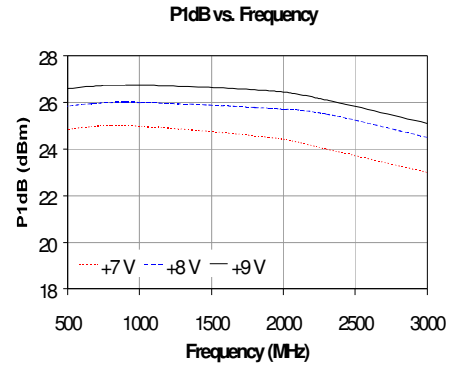
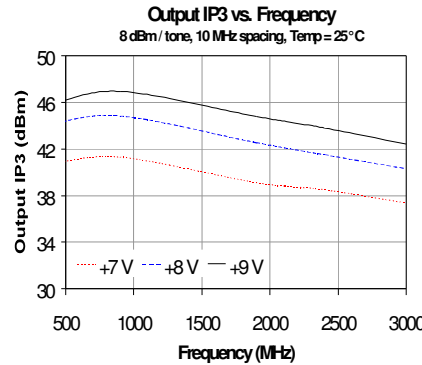
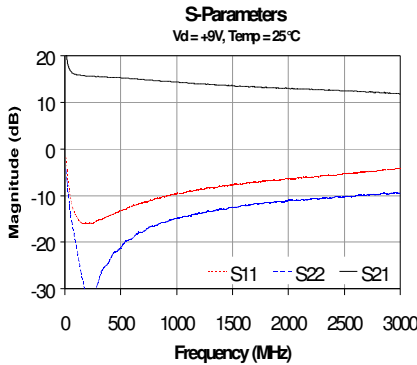

S-Parameters ($V_{DS} = +9\text{ V}$, $I_{DS} = 200\text{ mA}$, $T = 25\text{ }^{\circ}\text{C}$, unmatched 50 ohm system, calibrated to device leads)

Freq (MHz)	S11 (dB)	S11 (ang)	S21 (dB)	S21 (ang)	S12 (dB)	S12 (ang)	S22 (dB)	S22 (ang)
50	-10.52	-67.44	16.70	161.42	-19.60	15.17	-13.87	-71.59
100	-14.38	-71.97	15.99	164.33	-19.33	4.56	-20.59	-73.74
200	-15.96	-79.59	15.67	161.23	-19.25	-3.24	-31.69	-37.96
400	-14.26	-97.77	15.34	149.69	-19.46	-13.66	-24.05	41.02
600	-12.32	-113.84	15.05	136.98	-19.68	-22.39	-19.28	34.21
800	-10.79	-127.15	14.64	125.04	-20.00	-29.57	-16.57	23.81
1000	-9.66	-138.79	14.33	113.77	-20.41	-37.29	-14.96	12.82
1200	-8.75	-149.08	13.99	102.45	-20.76	-43.79	-13.80	1.56
1400	-8.08	-157.98	13.67	91.00	-21.26	-50.64	-12.94	-9.52
1600	-7.37	-165.53	13.45	80.21	-21.75	-56.57	-12.17	-21.95
1800	-6.87	-171.92	13.24	69.79	-22.32	-63.25	-11.48	-34.63
2000	-6.37	-178.50	13.02	58.73	-22.88	-69.25	-11.05	-47.68
2200	-6.00	174.94	12.78	47.41	-23.60	-76.47	-10.74	-61.29
2400	-5.61	169.08	12.59	36.08	-24.44	-82.56	-10.46	-74.90
2600	-5.12	162.18	12.42	23.91	-25.41	-88.72	-10.05	-88.98
2800	-4.66	156.21	12.14	11.75	-26.51	-93.74	-9.83	-103.94
3000	-4.43	152.94	11.96	5.65	-27.12	-96.59	-9.68	-110.63

Device S-parameters are available for download off of the website at: <http://www.wj.com>

Application Circuit PC Board Layout

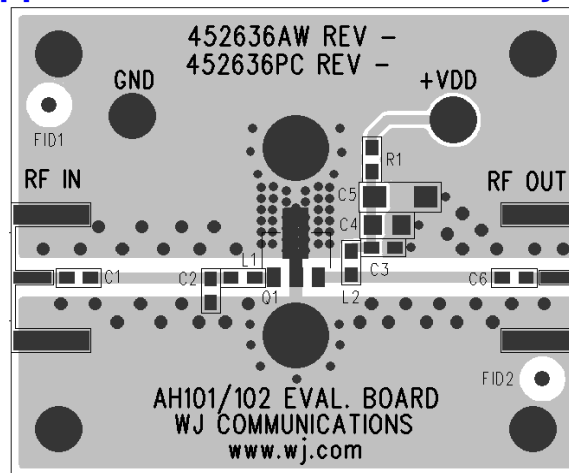

Circuit Board Material: .014" Getek ($\epsilon_r=4.2$), four layer, 1 oz copper
Microstrip line details: width = .026", spacing = .026"

Application Circuit: 900 MHz (AH102A-PCB900)

Typical RF Performance at 25°C

Frequency	900 MHz
Gain	14.5 dBm
Input Return Loss	22 dB
Output Return Loss	30 dB
Output P1dB	+27 dBm
Output IP3	+46 dBm
IS-95A Ch. Power @ -45 dBc ACPR	+21 dBm
Noise Figure	3.1 dB
Supply Voltage	+9 V
Supply Current	200 mA

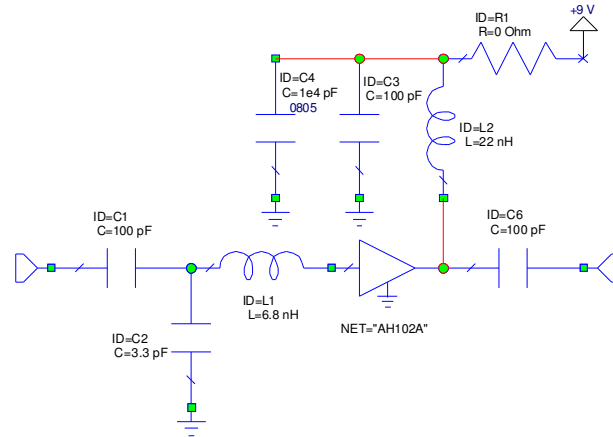

Notes:

1. The amplifier should be connected directly to a +9 V regulator; no dropping resistor is required.
2. If no DC signal is present at the input (pin 1), C1 can be removed. The gate (input pin) is internally grounded in the amplifier.
3. R1 is used as a placeholder for a different application circuit. It can be removed from the circuit.

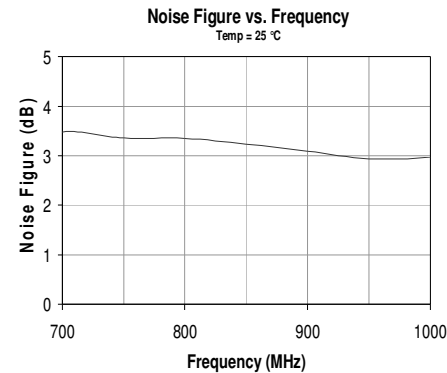
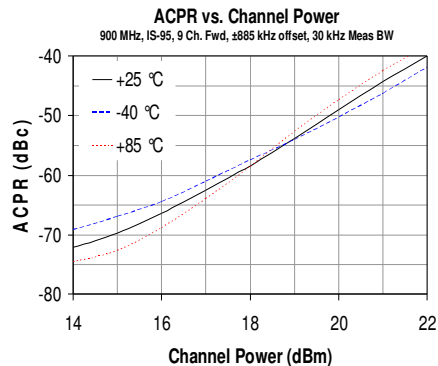
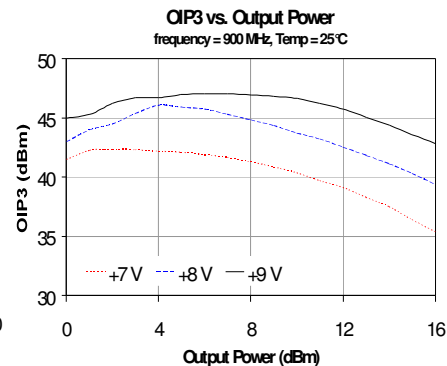
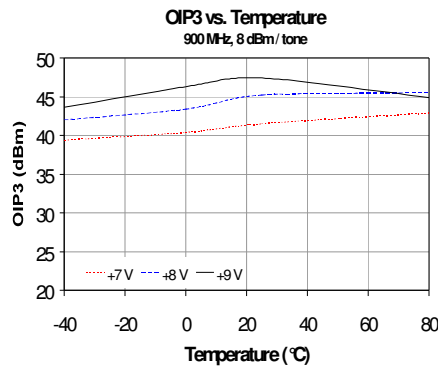
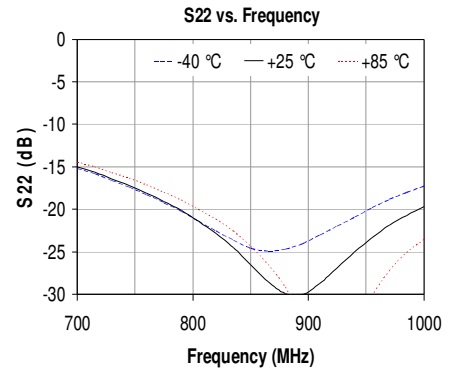
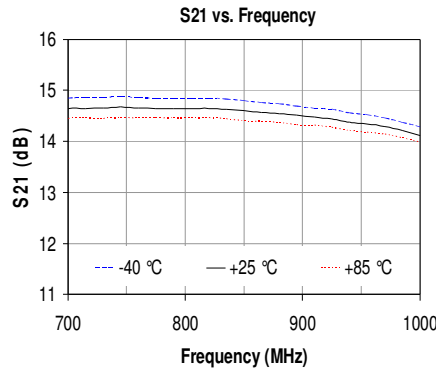
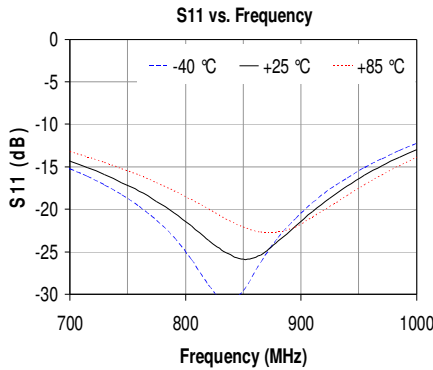

Application Circuit: 1900 / 2140 MHz (AH102A-PCB2000)

Typical RF Performance at 25°C

Frequency	1900	2140	Units
Gain	13.6	13.5	dB
Input Return Loss	16	19	dB
Output Return Loss	15	15	dB
Output P1dB	+27	+27	dBm
Output IP3	+45	+44	dBm
IS-95A Ch. Power @ -45 dBc ACPR	+20		dBm
W-CDMA Ch. Power @ -45 dBc ACLR		+18.2	dBm
Noise Figure	3.8	3.7	dB
Supply Voltage	+9		V
Supply Current	200		mA

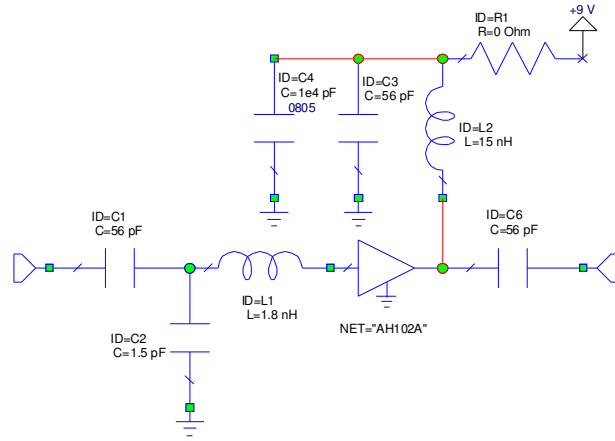

Notes:

1. The amplifier should be connected directly to a +9 V regulator; no dropping resistor is required.
2. If no DC signal is present at the input (pin 1), C1 can be removed. The gate (input pin) is internally grounded in the amplifier.
3. R1 is used as a placeholder for a different application circuit. It can be removed from the circuit.

S11 vs. Frequency

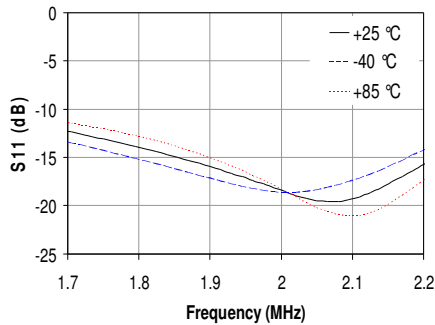

S21 vs. Frequency

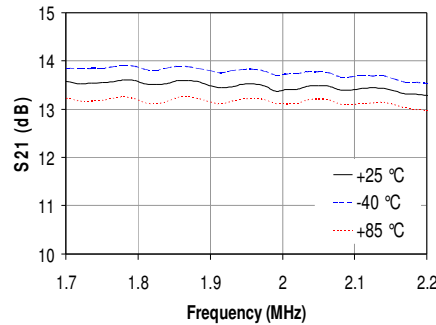

S22 vs. Frequency

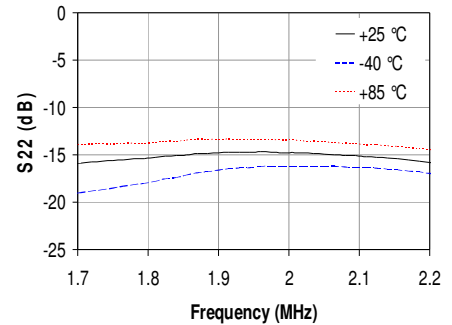

OIP3 vs. Output Power
frequency = 1900 MHz

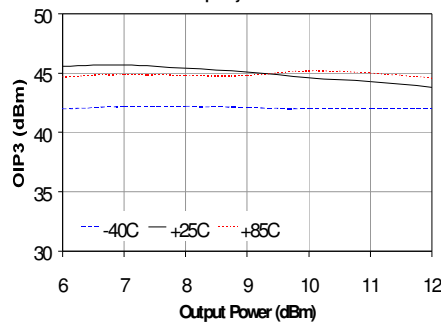

OIP3 vs. Output Power
frequency = 2140 MHz

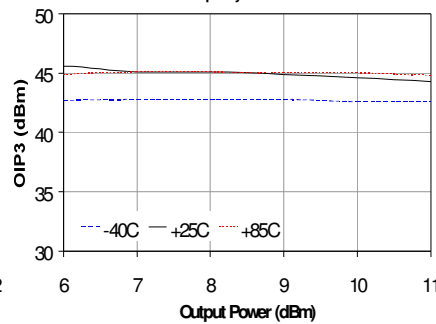

P1dB vs. Frequency

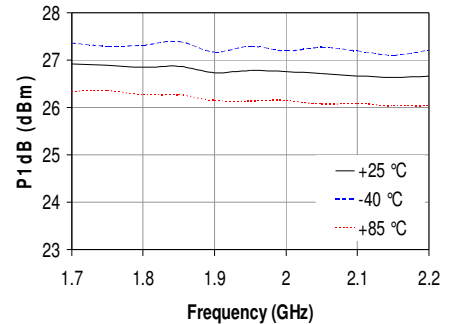

ACPR vs. Channel Power
1900 MHz, IS-95, 9 Ch. Fwd, 5885 kHz offset, 30 kHz Meas BW

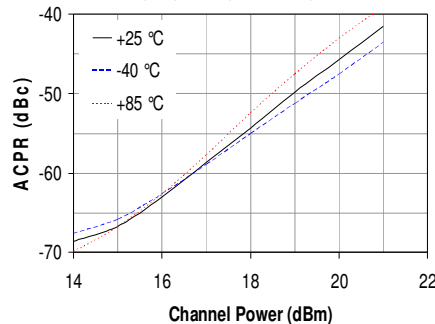

ACLR vs. Channel Power
2140 MHz, 3GPP W-CDMA, Test Model 1 +64 DPCH, 5 MHz offset

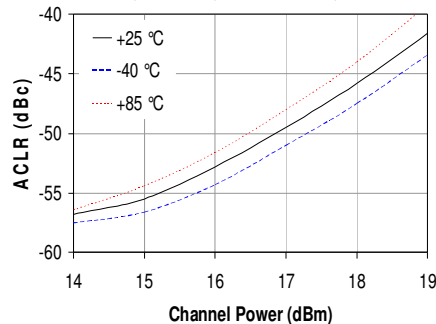

Noise Figure vs. Frequency

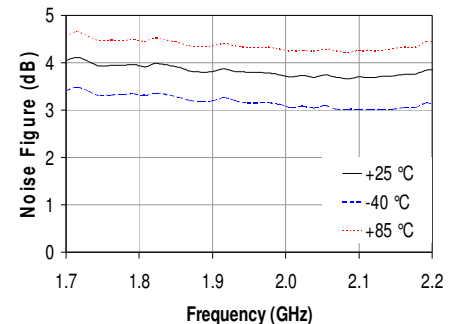

AH102A

Medium Power, High Linearity Amplifier



AH102A-G (Green / Lead-free SOT-89 Package) Mechanical Information

This package is lead-free/Green/RoHS-compliant. It is compatible with both lead-free (maximum 260 °C reflow temperature) and leaded (maximum 245 °C reflow temperature) soldering processes. The plating material on the leads is NiPdAu.

Outline Drawing

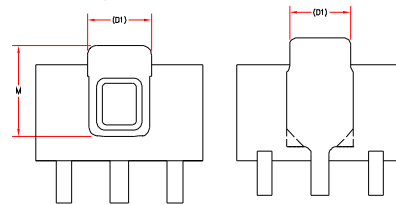
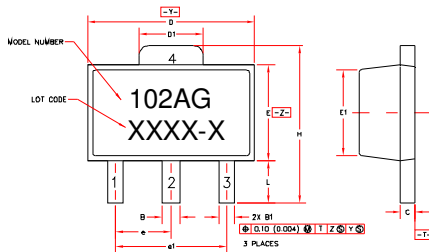

Alternate Backside Patterns
(May be supplied with either pattern shown)

SYMBOL	MIN	NDM	MAX	SYMBOL	MIN	NDM	MAX
A	1.40 (.055)	1.50 (.059)	1.60 (.063)	E	2.28 (.090)	2.50 (.098)	2.60 (.102)
B	.44 (.017)	.50 (.020)	.56 (.022)	E1	2.15 (.084)	2.20 (.087)	2.28 (.090)
BI	.38 (.014)	.42 (.016)	.46 (.017)	e	1.50 PSC (.059)		
C	.35 (.014)	.40 (.016)	.44 (.017)	e1	3.00 PSC (.118)		
D	4.40 (.173)	4.50 (.177)	4.60 (.181)	H	3.94 (.155)	4.10 (.161)	4.25 (.167)
DI	1.62 (.064)	1.75 (.069)	1.85 (.072)	L	.89 (.035)	1.10 (.043)	1.30 (.051)
				M	2.2 (.087)	2.40 (.095)	2.6 (.102)

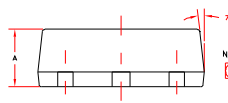

- NOTES:
 1. DIMENSIONS CONFORM WITH JEDEC TO-243C EXCEPT WHERE INDICATED.
 2. DIMENSIONS ARE EXPRESSED IN MM (INCHES).
 3. DIMENSIONING AND TOLERANCING IN MM AND SI.

Product Marking

The AH102A-G will be marked with a "102AG" designator and an alphanumeric lot code.

Tape and reel specifications for this part are located on the website in the "Application Notes" section.

MSL / ESD Rating



Caution! ESD sensitive device.

ESD Rating: Class 1C
 Value: Passes $\geq 1000V$ min.
 Test: Human Body Model (HBM)
 Standard: JEDEC Standard JESD22-A114

ESD Rating: Class IV
 Value: Passes $\geq 1000V$ min.
 Test: Charged Device Model (CDM)
 Standard: JEDEC Standard JESD22-C101

MSL Rating: Level 1 at +260 °C convection reflow
 Standard: JEDEC Standard J-STD-020

Land Pattern

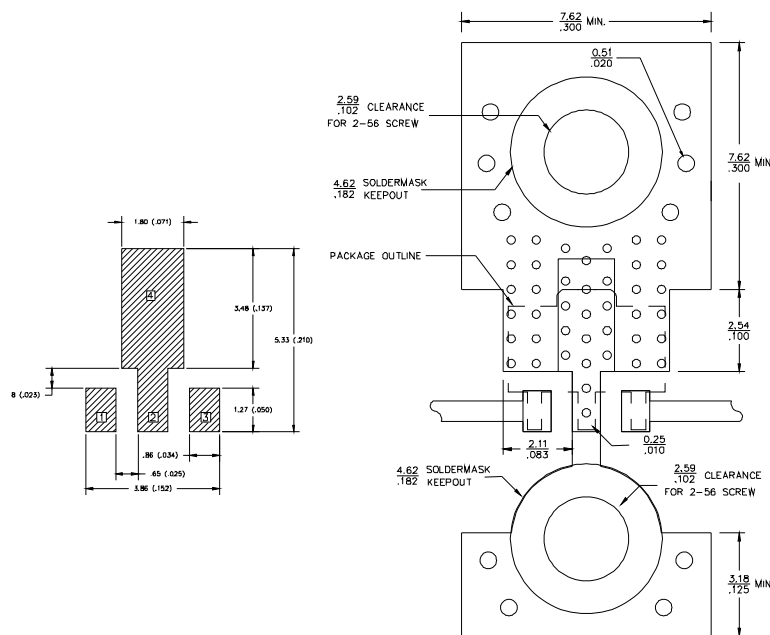

Mounting Config. Notes

- Ground / thermal vias are critical for the proper performance of this device. Vias should use a .35mm (#80 / .0135") diameter drill and have a final plated thru diameter of .25 mm (.010").
- Add as much copper as possible to inner and outer layers near the part to ensure optimal thermal performance.
- Mounting screws can be added near the part to fasten the board to a heatsink. Ensure that the ground / thermal via region contact the heatsink.
- Do not put solder mask on the backside of the PC board in the region where the board contacts the heatsink.
- RF trace width depends upon the PC board material and construction.
- Use 1 oz. Copper minimum.
- All dimensions are in millimeters (inches). Angles are in degrees.