

Applications

- Mobile Infrastructure
- CATV / FTTX
- W-LAN / ISM
- WCDMA / LTE



SOT-89 Package

Product Features

- DC – 3000 MHz
- +19.5 dBm P1dB at 900 MHz
- +33 dBm OIP3 at 900 MHz
- 18.5 dB Gain at 900 MHz
- Single Voltage Supply
- SOT-89 package
- Internally matched to 50 Ω

Functional Block Diagram

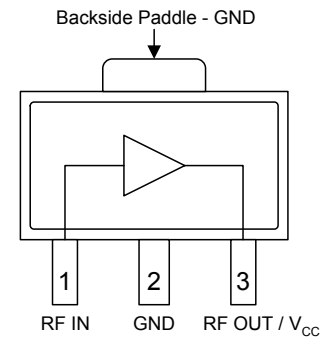

General Description

The AG603-89G is a general-purpose buffer amplifier that offers high dynamic range in a low-cost, surface-mount package. At 900 MHz, the AG603-89 typically provides 14 dB of gain, +33 dBm OIP3, and +18.5 dBm P1dB. This amplifier combines dependable performance with consistent quality to maintain an MTTF exceeding 1000 years at mounting temperatures of +85 °C.

The AG603-89G consists of Darlington pair amplifiers using the high reliability InGaP/GaAs HBT process technology and only requires DC-blocking capacitors, a bias resistor, and an inductive RF choke for operation.

The broadband MMIC amplifier can be directly applied to various current and next generation wireless technologies such as GSM, CDMA, W-CDMA and LTE. In addition, the AG603-89 will work for other various applications within the DC to 3.5 GHz frequency range such as CATV.

The AG603-89G is housed in a lead-free/green/RoHS-compliant SOT-89 industry-standard SMT package.

Pin Configuration

Pin No.	Label
1	RF IN
2	GND
3	RF OUT / V _{CC}
Backside Paddle	GND

Ordering Information

Part No.	Description
AG603-89G	InGaP/GaAs HBT Gain Block
AG603-89PCB	0.7-2.4 GHz Evaluation Board

Standard T/R size = 3000 pieces on a 13" reel

Absolute Maximum Ratings

Parameter	Rating
Storage Temperature	-55 to 150 °C
RF Input Power, CW, 50 Ω, T=25 °C	+10 dBm
Device Voltage (V _{CC})	+7 V

Operation of this device outside the parameter ranges given above may cause permanent damage.

Recommended Operating Conditions

Parameter	Min	Typ	Max	Units
T _{CASE}	-40		+85	°C
T _j for >10 ⁶ hours MTTF			+177	°C

Electrical specifications are measured at specified test conditions. Specifications are not guaranteed over all recommended operating conditions.

Electrical Specifications

Test conditions unless otherwise noted: V_{SUPPLY}=+6 V, R_{BIAS}=11.2 Ω, I_{CC} =75 mA (typ.), T_{CASE}= +25 °C, 50 Ω system

Parameter	Conditions	Min	Typ	Max	Units
Operational Frequency Range		DC		3500	MHz
Gain	f=900 MHz		18.5		dB
	f=1900 MHz	15.5	16.5	17.5	dB
Input Return Loss			18		dB
Output Return Loss			14		dB
Output P1dB	f=900 MHz		+19.3		dBm
	f=1900 MHz		+18.7		dBm
Output IP3	P _{out} =+2 dBm/tone, Δf= 10 MHz	f=900 MHz	+33.2		dBm
		f=1900 MHz	+33.0		dBm
Output IP2			+45		dBm
Noise Figure			3.9		dB
Device Voltage (V _{CC})			5.16		V
Device Current (I _{CC})			75		mA
Thermal Resistance, (θ _{jc})	Junction to case ⁽¹⁾		154		°C/W

Notes:

1. Thermal path is from the device junction to the backside ground paddle.

S-Parameters

Test Conditions: $V_{CC}=+5.16$ V (typ.), $I_{CC}=75$ mA (typ.), $T_{CASE}=+25$ °C, 50 Ω system, calibrated to device leads

Freq (MHz)	S11 (dB)	S11 (ang)	S21 (dB)	S21 (ang)	S12 (dB)	S12 (ang)	S22 (dB)	S22 (ang)
50	-17.44	-179.21	19.75	176.96	-22.08	-0.65	-30.21	-157.09
250	-17.55	169.85	19.62	165.49	-22.50	0.12	-25.52	-140.18
500	-16.33	155.63	19.38	151.11	-22.67	-5.41	-18.87	-152.26
750	-16.49	144.00	19.03	137.34	-22.45	-5.63	-16.22	-154.81
1000	-17.80	130.88	18.59	124.33	-22.66	-13.12	-14.49	-160.35
1250	-18.70	119.59	18.16	111.75	-22.40	-12.10	-12.89	-164.96
1500	-20.48	106.91	17.63	100.07	-22.23	-14.79	-12.04	-169.44
1750	-22.81	88.42	17.10	88.76	-22.08	-16.04	-11.36	-174.80
2000	-24.74	60.37	16.56	77.95	-21.89	-20.42	-10.95	179.74
2250	-21.87	29.86	16.12	68.02	-21.72	-22.87	-10.69	-176.50
2500	-22.77	18.29	15.76	60.37	-21.93	-29.82	-10.61	173.91
2750	-23.12	18.81	15.31	49.71	-21.11	-31.74	-10.58	159.59
3000	-22.25	26.15	14.81	39.30	-21.00	-31.75	-10.22	143.79
3250	-20.31	42.35	14.34	29.43	-20.82	-38.05	-9.59	125.14
3500	-17.65	52.62	13.78	19.36	-20.84	-43.03	-8.43	108.91
3750	-15.03	53.03	13.17	9.56	-20.59	-49.28	-7.32	95.17
4000	-13.12	55.09	12.59	0.02	-20.50	-52.56	-6.47	84.81
4250	-12.12	53.85	12.02	-8.87	-20.30	-58.22	-5.78	76.60
4500	-11.59	53.30	11.51	-17.30	-20.17	-63.33	-5.49	68.35
4750	-11.70	51.75	11.11	-26.46	-20.05	-68.23	-5.33	62.23
5000	-12.17	48.19	10.84	-35.22	-19.48	-72.90	-5.48	56.23
5250	-13.17	43.40	10.56	-44.04	-19.40	-78.82	-5.82	48.68
5500	-14.11	36.29	10.29	-53.54	-19.03	-84.21	-6.08	40.56
5750	-14.62	22.26	10.11	-63.62	-18.72	-91.82	-6.19	29.58
6000	-13.49	5.63	9.76	-74.55	-18.78	-102.14	-5.94	16.34

AG603-89PCB Evaluation Board

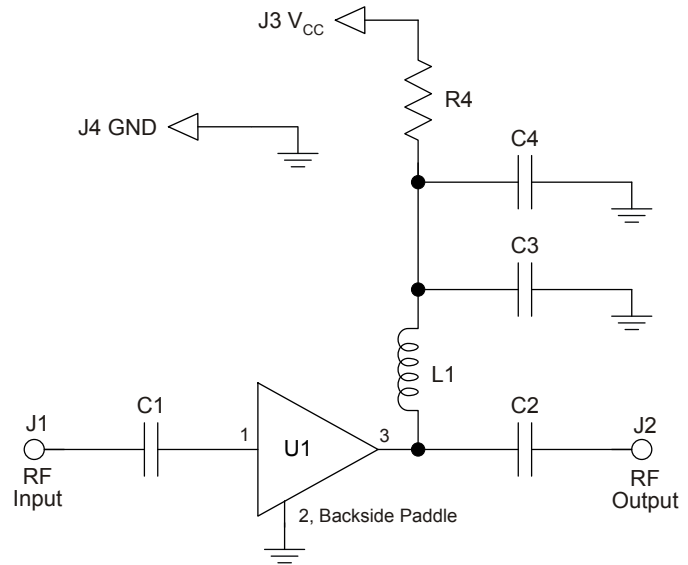
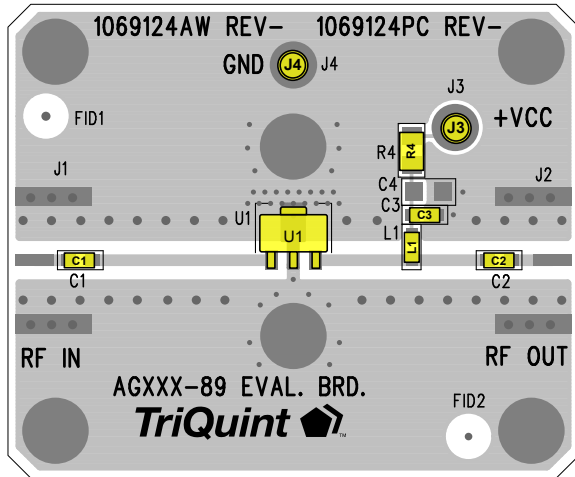

Notes:

1. See Evaluation Board PCB Information section for material and stack-up.
2. All components are of 0603 size unless otherwise stated.

Bill of Material – AG603-89PCB

Reference Des.	Value	Description	Manuf.	Part Number
U1	n/a	InGaP HBT Gain Block	TriQuint	AG603-89G
L1	39 nH	Inductor, 0603, 5%, CS Series	Coilcraft	0603CS-39NXJL
C1, C2	56 pF	Cap, Chip, 0603, 50V, NPO, 5%	various	
C3	0.018 uF	Cap, Chip, 0603, 16V, X7R, 10%	various	
C4	DNP	Do not populate		
R4	11.2 Ω	Res, Chip, 0805, 1/10W, 1%	various	

Recommended Component Values for Specific Frequencies

Frequency (MHz)	50	500	900	1900	2200	2500	3500
L1	820 nH	220 nH	68 nH	27 nH	22 nH	18 nH	15 nH
C1, C2	.018 uF	1000 pF	100 pF	68 pF	68 pF	56 pF	39 pF

Bias Resistor Values for Various Supply Voltages

V _{SUPPLY} (V)	6	7	8	9	10	12
R1	11.2 Ω	24.5 Ω	38 Ω	51 Ω	65 Ω	91 Ω
Component Size	0805	1210	1210	2010	2010	2512

The proper value for R1 is dependent upon the supply voltage and allows for bias stability over temperature. A minimum supply voltage of +6 V is required. A 1% tolerance resistor is recommended.

Typical Performance – AG603-89PCB

Test conditions unless otherwise noted: $V_{SUPPLY} = +6V$, $R_1 = 11.2\ \Omega$, $I_{CC} = 75\text{ mA (typ.)}$, $T_{CASE} = +25\ ^\circ\text{C}$

Parameter	Typical Value								Units
Frequency	100	500	900	1900	2140	2400	3500	5800	MHz
Gain	19.4	19.1	18.5	16.5	16.0	15.5	13.5	9.7	dB
Input Return Loss	18	16	18	24	21	22	17	14	dB
Output Return Loss	29	18	14	11	11	10	8	6	dB
Output P1dB	+19.3	+19.3	+19.3	+18.7	+18.6	+18.6	+17.0		dBm
Output IP3 ⁽¹⁾	+33.7	+33.6	+33.2	+33.0	+33.0	+32.8			dBm
Noise Figure	3.8	3.8	3.9	4.1	4.1	4.2			dB

Notes:

1. OIP3 measured with two tones at an output power of +2 dBm / tone separated by 10 MHz.
2. Data is shown as device performance only. Actual implementation for the desired frequency band will be determined by external components shown in the application circuit.

Performance Plots – AG603-89PCB

Test conditions unless otherwise noted: $V_{SUPPLY} = +6V$, $R_1 = 11.2\ \Omega$, $I_{CC} = 75\text{ mA (typ.)}$, $T_{CASE} = +25\ ^\circ\text{C}$

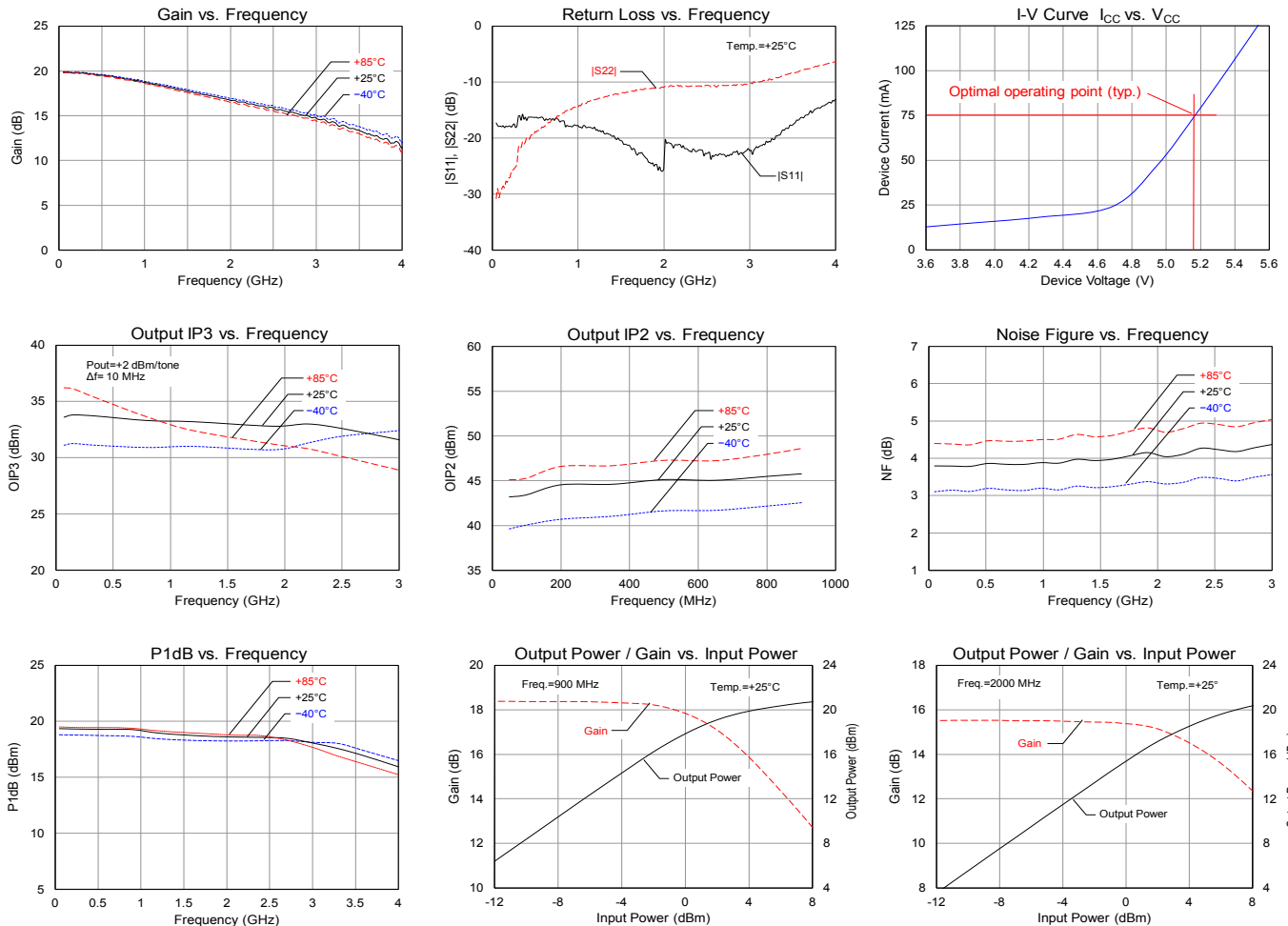

Performance Plots – AG603-89PCB

Test conditions unless otherwise noted: $V_{SUPPLY} = +6\text{ V}$, $R_1 = 11.2\ \Omega$, $I_{CC} = 75\text{ mA (typ.)}$, $T_{CASE} = +25\text{ }^\circ\text{C}$

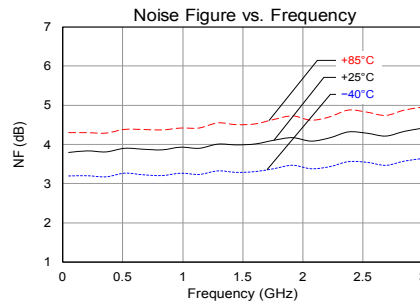
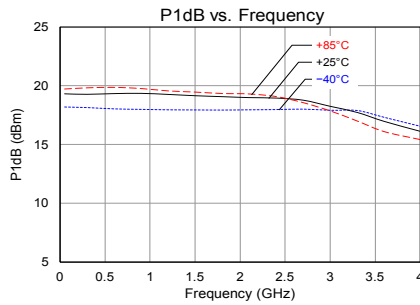
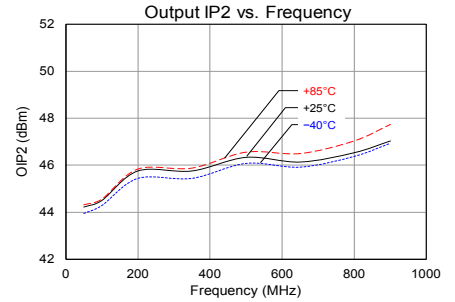
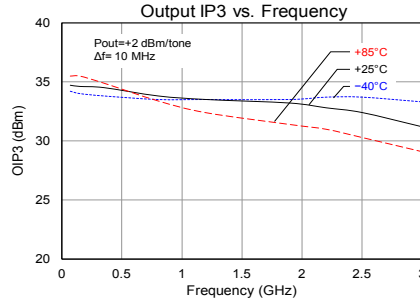
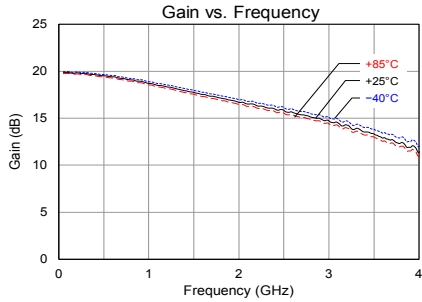

Pin Configuration and Description

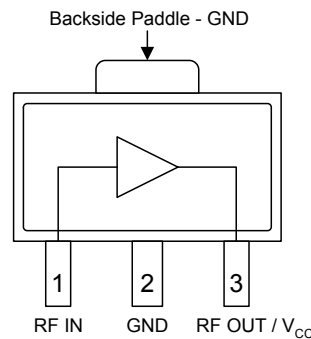

Pin No.	Label	Description
1	RF IN	RF input, matched to 50 ohms. External DC Block is required.
2, Backside Paddle	GND	RF/DC ground. Use recommended via pattern to minimize inductance and thermal resistance. See PCB Mounting Pattern for suggested footprint.
3	RF OUT / V _{CC}	RF output / DC supply, matched to 50 ohms. External DC Block, bias choke, and dropping resistor are required.

Evaluation Board PCB Information

TriQuint PCB 1075825 Material and Stack-up

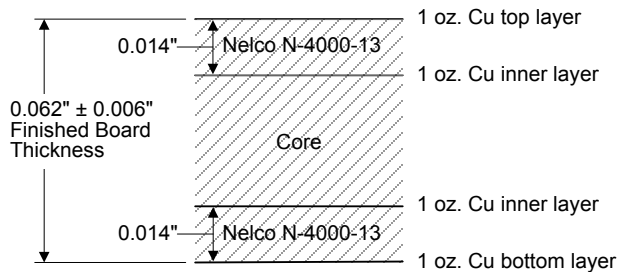

50 Ohm Line Dimensions: Width=0.028"
Spacing=0.028"

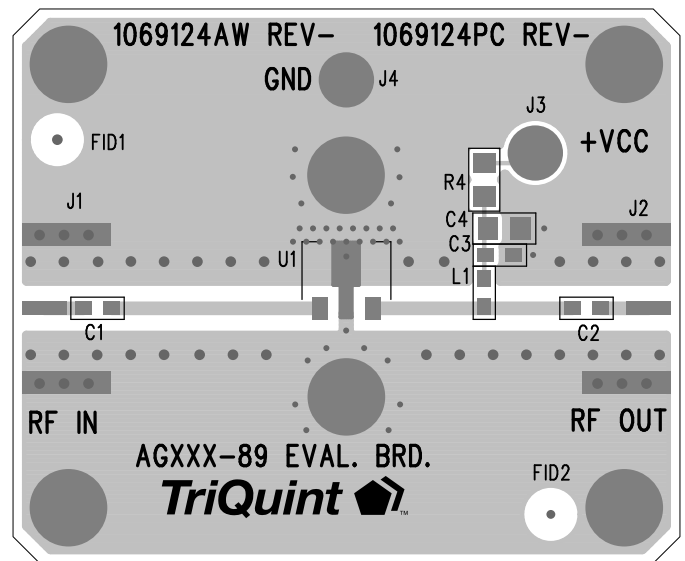

Package Marking and Dimensions

Package Marking
 Product Identifier: A603G
 Date/Assembly Code: YXXX

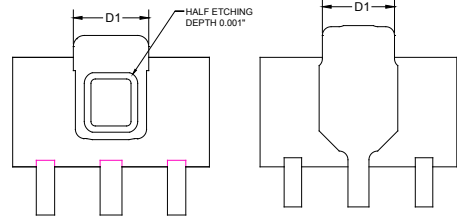
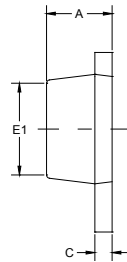
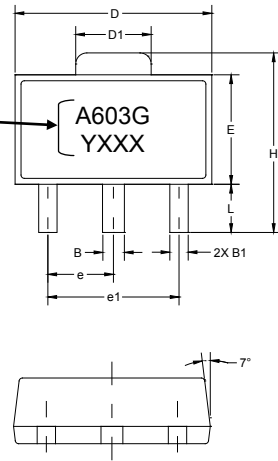

Alternate Backside Patterns - Reflow Compatible
 (Part may be supplied with either pattern)

SYMBOL	MIN	TYP	MAX
A	1.40 (.055)	1.50 (.059)	1.60 (.063)
B	.44 (.017)	.50 (.020)	.56 (.022)
B1	.36 (.014)	.42 (.0165)	.48 (.019)
C	.35 (.014)	.40 (.016)	.44 (.017)
D	4.40 (.173)	4.50 (.177)	4.60 (.181)
D1	1.62 (.064)	1.73 (.068)	1.83 (.072)

SYMBOL	MIN	TYP	MAX
E	2.29 (.090)	2.50 (.098)	2.60 (.102)
E1	2.13 (.084)	2.20 (.087)	2.29 (.090)
e		1.50 BSC (.059)	
e1		3.00 BSC (.118)	
H	3.94 (.155)	4.10 (.161)	4.25 (.167)
L	.89 (.035)	1.10 (.043)	1.20 (.047)

Notes:

1. All dimensions are in millimeters (inches). Angles are in degrees.
2. Dimension and tolerance formats conform to ASME Y14.4M-1994.
3. The terminal #1 identifier and terminal numbering conform to JESD 95-1 SPP-012.
4. Contact plating: NiPdAu

PCB Mounting Pattern

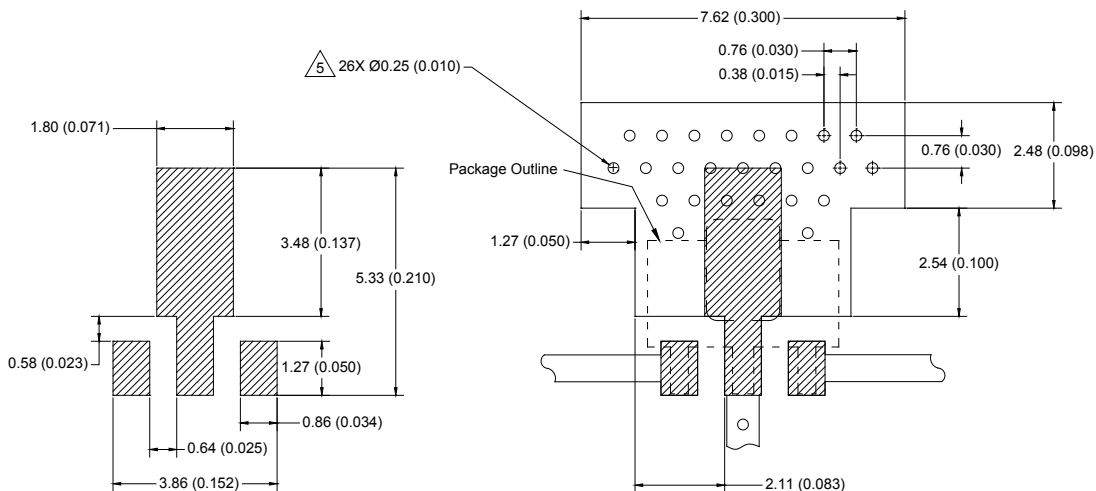

Notes:

1. All dimensions are in millimeters (inches). Angles are in degrees.
2. Use 1 oz. copper minimum for top and bottom layer metal.
3. Vias are required under the backside paddle of this device for proper RF/DC grounding and thermal dissipation.
4. Do not remove or minimize via hole structure in the PCB. Thermal and RF grounding is critical.
5. We recommend a 0.35mm (#80/.0135") diameter bit for drilling via holes and a final plated thru diameter of 0.25 mm (0.10").
6. Ensure good package backside paddle solder attach for reliable operation and best electrical performance.

Product Compliance Information

ESD Sensitivity Ratings



Caution! ESD-Sensitive Device

ESD Rating: Class 1C
Value: ≥ 1000 V and < 2000 V
Test: Human Body Model (HBM)
Standard: ESDA/ JEDEC Standard JS-001-2012

ESD Rating: Class C3
Value: Passes ≥ 1000 V
Test: Charged Device Model (CDM)
Standard: JEDEC Standard JESD22-C101F

MSL Rating

MSL Rating: Level 3
Test: 260°C convection reflow
Standard: JEDEC Standard IPC/JEDEC J-STD-020

Solderability

Compatible with both lead-free (260°C maximum reflow temperature) and tin/lead (245°C maximum reflow temperature) soldering processes.

Contact plating: NiPdAu

RoHs Compliance

This part is compliant with EU 2002/95/EC RoHS directive (Restrictions on the Use of Certain Hazardous Substances in Electrical and Electronic Equipment).

This product also has the following attributes:

- Lead Free
- Halogen Free (Chlorine, Bromine)
- Antimony Free
- TBBP-A (C₁₅H₁₂Br₄O₂) Free
- PFOS Free
- SVHC Free

Contact Information

For the latest specifications, additional product information, worldwide sales and distribution locations, and information about TriQuint:

Web: www.triquint.com **Tel:** +1.503.615.9000
Email: info-sales@triquint.com **Fax:** +1.503.615.8902

For technical questions and application information:

Email: sjapplications.engineering@triquint.com

Important Notice

The information contained herein is believed to be reliable. TriQuint makes no warranties regarding the information contained herein. TriQuint assumes no responsibility or liability whatsoever for any of the information contained herein. TriQuint assumes no responsibility or liability whatsoever for the use of the information contained herein. The information contained herein is provided "AS IS, WHERE IS" and with all faults, and the entire risk associated with such information is entirely with the user. All information contained herein is subject to change without notice. Customers should obtain and verify the latest relevant information before placing orders for TriQuint products. The information contained herein or any use of such information does not grant, explicitly or implicitly, to any party any patent rights, licenses, or any other intellectual property rights, whether with regard to such information itself or anything described by such information.

TriQuint products are not warranted or authorized for use as critical components in medical, life-saving, or life-sustaining applications, or other applications where a failure would reasonably be expected to cause severe personal injury or death.