

MOS FIELD EFFECT TRANSISTOR  
**3SK131**

RF AMP. FOR VHF TV TUNER  
 N-CHANNEL SILICON DUAL-GATE MOS FIELD-EFFECT TRANSISTOR  
 4PIN MINI MOLD

**FEATURES**

- Suitable for use as RF amplifier in VHF TV tuner.
- Low  $C_{rss}$  : 0.05 pF TYP.
- High  $G_{ps}$  : 23 dB TYP.
- Low NF : 1.3 dB TYP.

**ABSOLUTE MAXIMUM RATINGS (TA = 25 °C)**

Drain to Source Voltage	$V_{DSX}$	20	V
Gate1 to Source Voltage	$V_{G1S}$	$\pm 8$	V
Gate2 to Source Voltage	$V_{G2S}$	$\pm 8$	V
Drain Current	$I_D$	25	mA
Total Power Dissipation	$P_T$	200	mW
Channel Temperature	$T_{ch}$	125	°C
Storage Temperature	$T_{stg}$	-55 to +125	°C

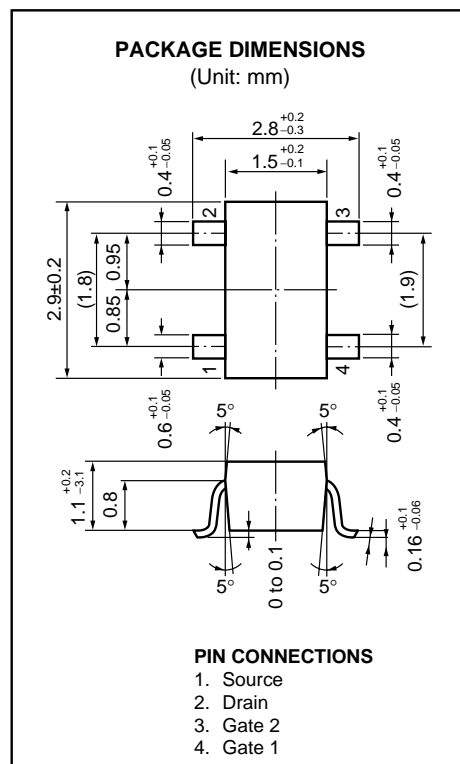

**ELECTRICAL CHARACTERISTICS (TA = 25 °C)**

CHARACTERISTIC	SYMBOL	MIN.	TYP.	MAX.	UNIT	TEST CONDITIONS
Drain to Source Breakdown Voltage	$BV_{DSX}$	20			V	$V_{G1S} = V_{G2S} = -2 V, I_D = 10 \mu A$
Drain Current	$I_{DSS}$	7	10	25	mA	$V_{DS} = 6 V, V_{G2S} = 3 V, V_{G1S} = 0$
Gate1 to Source Cutoff Voltage	$V_{G1S(OFF)}$			-2.0	V	$V_{DS} = 8 V, V_{G2S} = 0, I_D = 5 \mu A$
Gate2 to Source Cutoff Voltage	$V_{G2S(OFF)}$			-1.5	V	$V_{DS} = 8 V, V_{G1S} = 0, I_D = 5 \mu A$
Gate1 Reverse Current	$I_{G1SS}$			$\pm 20$	nA	$V_{DS} = 0, V_{G1S} = \pm 8 V, V_{G2S} = 0$
Gate2 Reverse Current	$I_{G2SS}$			$\pm 20$	nA	$V_{DS} = 0, V_{G2S} = \pm 8 V, V_{G1S} = 0$
Forward Transfer Admittance	$ y_{fs} $	22	28		mS	$V_{DS} = 6 V, V_{G2S} = 3 V, I_D = 10 mA$ $f = 1 kHz$
Input Capacitance	$C_{iss}$	4.0	5.0	6.5	pF	$V_{DS} = 6 V, V_{G2S} = 3 V, I_D = 10 mA$
Output Capacitance	$C_{oss}$	2.2	2.9	3.7	pF	$f = 1 MHz$
Reverse Transfer Capacitance	$C_{rss}$		0.05	0.08	pF	
Power Gain	$C_{ps}$	21	24		dB	$V_{DS} = 10 V, V_{G2S} = 5 V, I_D = 10 mA$
Noise Figure	NF		1.2	2.5	dB	$f = 200 MHz$

$I_{DSS}$  classification V11 7-13 mA V12 11-19 mA V13 17-25 mA

TYPICAL CHARACTERISTICS (T<sub>A</sub> = 25 °C)

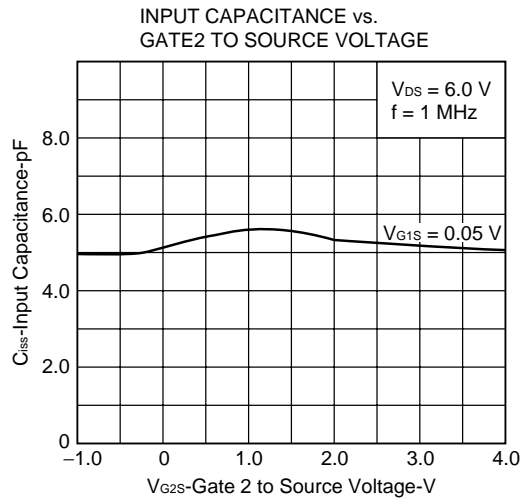
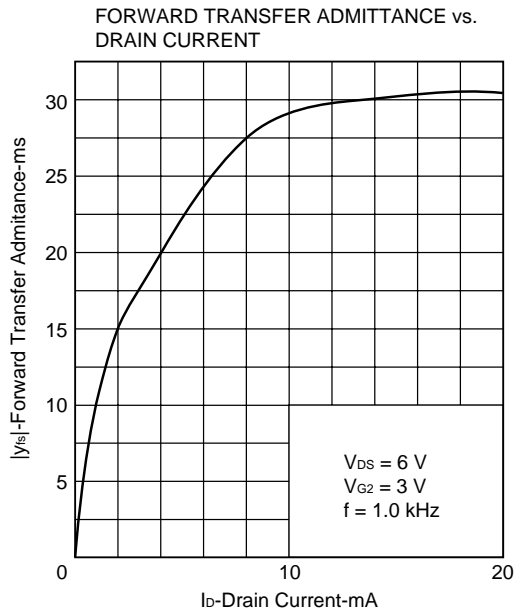
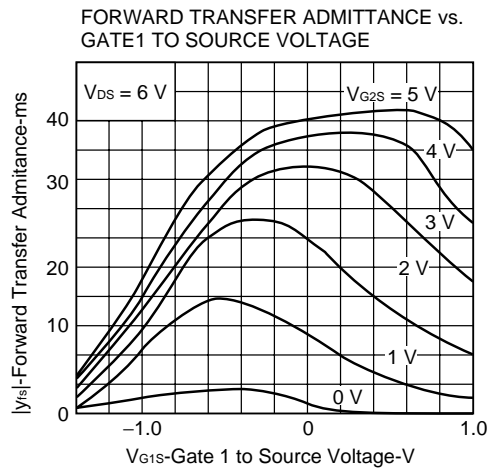
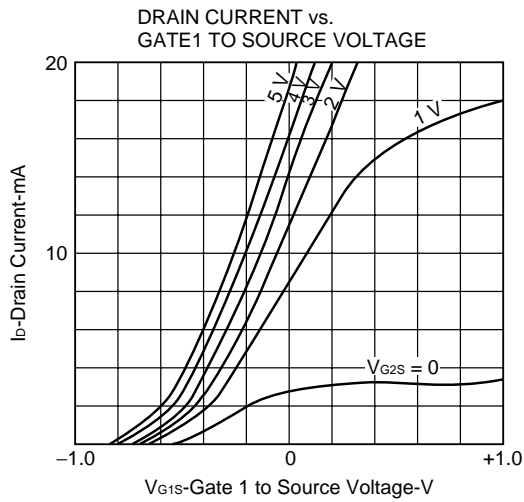
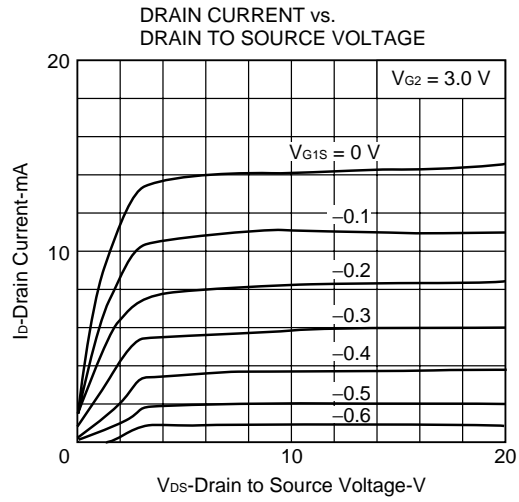
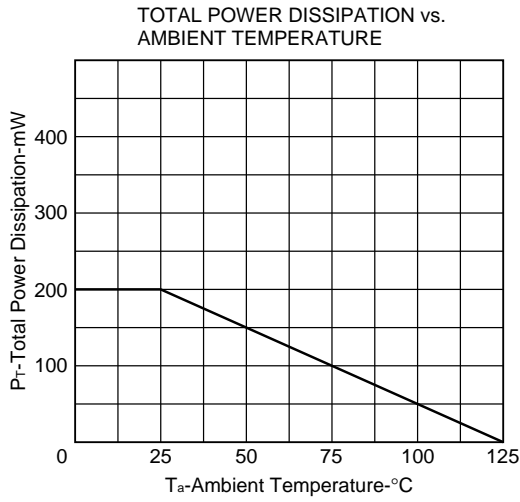

OUTPUT CAPACITANCE vs. GATE2 TO SOURCE VOLTAGE

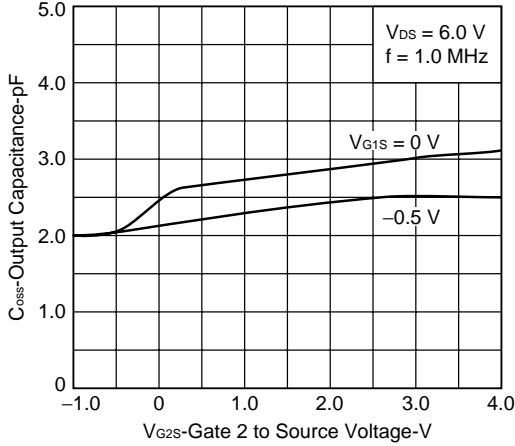

INPUT ADMITTANCE ( $y_{is}$ ) vs. FREQUENCY

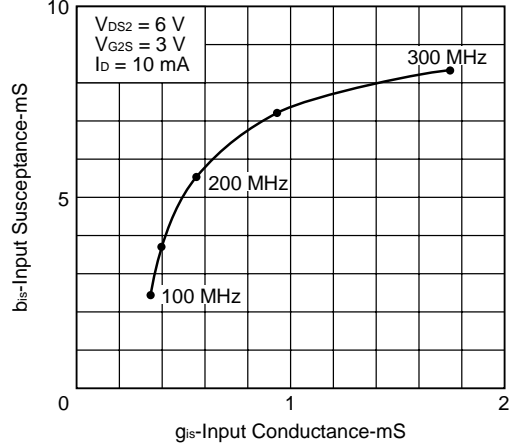

FORWARD TRANSFER ADMITTANCE ( $y_{fs}$ ) vs. FREQUENCY

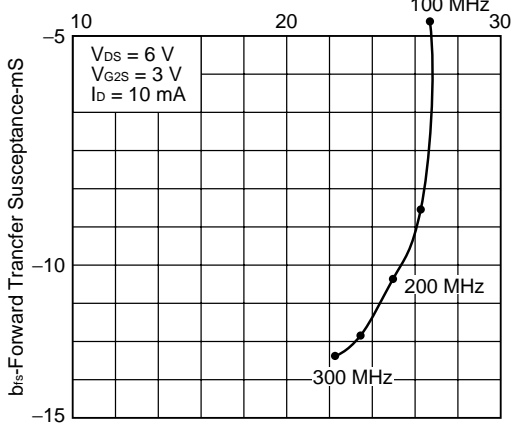

REVERSE TRANSFER ADMITTANCE ( $y_{rs}$ ) vs. FREQUENCY

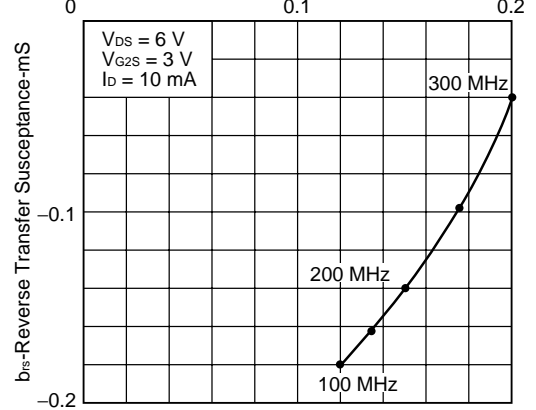

OUTPUT ADMITTANCE ( $y_{os}$ ) vs. FREQUENCY

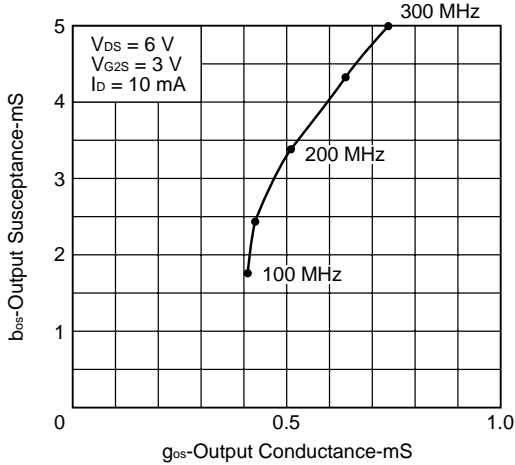

POWER GAIN vs. DRAIN CURRENT

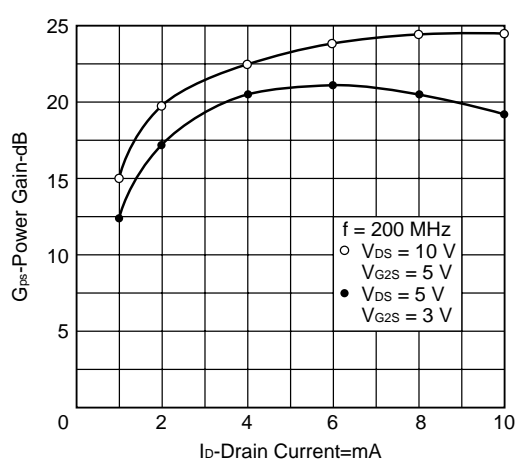

NOISE FIGURE vs. DRAIN CURRENT

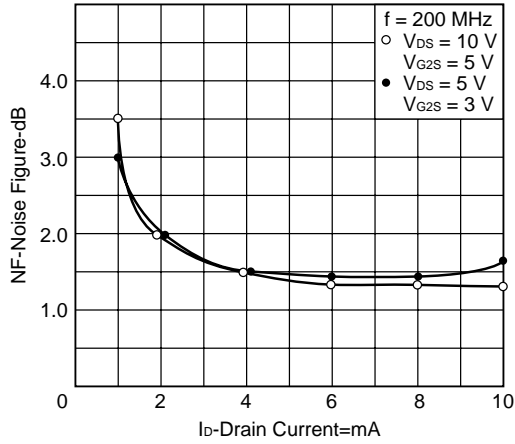

NOISE FIGURE, POWER GAIN vs. GATE2 TO SOURCE VOLTAGE

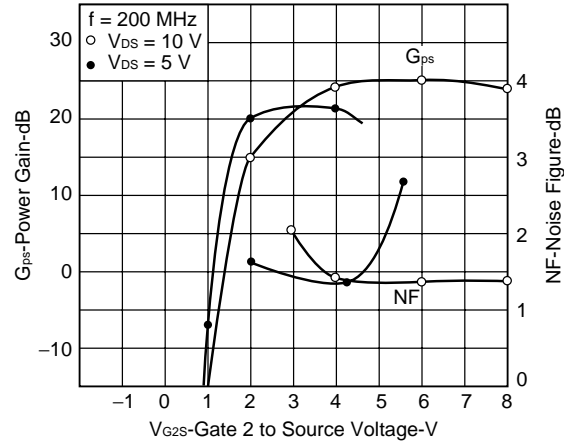

TEST CIRCUIT

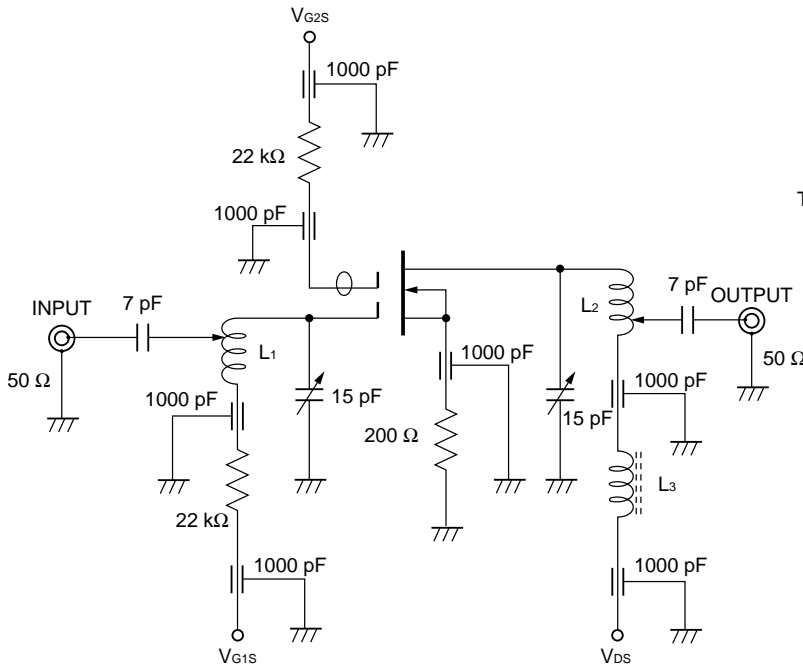

TEST CONDITION

- V<sub>ds</sub> = 10 V, V<sub>gs2</sub> = 5 V, I<sub>b</sub> = 10 mA
- f = 200 MHz
- L<sub>1</sub>: φ 0.6 mm U.E.W. 7 mm 3T
- L<sub>2</sub>: φ 0.6 mm U.E.W. 7 mm 3T
- L<sub>3</sub>: RFC 2.2 μH

[MEMO]

[MEMO]

[MEMO]

No part of this document may be copied or reproduced in any form or by any means without the prior written consent of NEC Corporation. NEC Corporation assumes no responsibility for any errors which may appear in this document.

NEC Corporation does not assume any liability for infringement of patents, copyrights or other intellectual property rights of third parties by or arising from use of a device described herein or any other liability arising from use of such device. No license, either express, implied or otherwise, is granted under any patents, copyrights or other intellectual property rights of NEC Corporation or others.

While NEC Corporation has been making continuous effort to enhance the reliability of its semiconductor devices, the possibility of defects cannot be eliminated entirely. To minimize risks of damage or injury to persons or property arising from a defect in an NEC semiconductor device, customers must incorporate sufficient safety measures in its design, such as redundancy, fire-containment, and anti-failure features.

NEC devices are classified into the following three quality grades:

"Standard", "Special", and "Specific". The Specific quality grade applies only to devices developed based on a customer designated "quality assurance program" for a specific application. The recommended applications of a device depend on its quality grade, as indicated below. Customers must check the quality grade of each device before using it in a particular application.

Standard: Computers, office equipment, communications equipment, test and measurement equipment, audio and visual equipment, home electronic appliances, machine tools, personal electronic equipment and industrial robots

Special: Transportation equipment (automobiles, trains, ships, etc.), traffic control systems, anti-disaster systems, anti-crime systems, safety equipment and medical equipment (not specifically designed for life support)

Specific: Aircrafts, aerospace equipment, submersible repeaters, nuclear reactor control systems, life support systems or medical equipment for life support, etc.

The quality grade of NEC devices is "Standard" unless otherwise specified in NEC's Data Sheets or Data Books. If customers intend to use NEC devices for applications other than those specified for Standard quality grade, they should contact an NEC sales representative in advance.

Anti-radioactive design is not implemented in this product.



This datasheet has been downloaded from:

[www.DatasheetCatalog.com](http://www.DatasheetCatalog.com)

Datasheets for electronic components.